

Laboratory Manual for Introduction to Physical Geography, Second Edition

Laboratory Manual for Introduction to Physical Geography, Second Edition

Stuart MacKinnon; Chani Welch; Katie Burles; Crystal Huscroft; Nina Hewitt; Gillian Krezoski; Andrew Perkins; Leonard Tang; Terence Day; Craig Nichol; Todd Redding; Allison Lutz; Ian Saunders; and Fes de Scally



Laboratory Manual for Introduction to Physical Geography, Second Edition by Stuart MacKinnon; Chani Welch; Katie Burles; Crystal Huscroft; Nina Hewitt; Gillian Krezoski; Andrew Perkins; Leonard Tang; Terence Day; Craig Nichol; Todd Redding; Allison Lutz; Ian Saunders; and Fes de Scally is licensed under a Creative Commons Attribution-NonCommercial-ShareAlike 4.0 International License (<https://creativecommons.org/licenses/by-nc-sa/4.0/>), except where otherwise noted.

Contents

Licensing Information	xi
<i>Cover Photo</i>	xi
<i>Images Used with Other Permissions</i>	xii
Territorial Acknowledgements	xvii
Contribution Acknowledgements	xix
Preface	xxi
Accessibility Statement	xxiii
Lab Exercises	
Tutorial: Using Spreadsheets in Geography	1
Craig Nichol	
Lab 01: Earth Systems and Earth's Four Spheres	3
Allison Lutz	
<i>Pre-Readings</i>	3
<i>Lab Exercises</i>	5
<i>Worksheets</i>	11
<i>References</i>	11
Lab 02: Earth-Sun Relationships and Earth's Energy Budget	13
Andrew Perkins	
<i>Pre-Readings</i>	13
<i>Lab Exercises</i>	24
<i>Worksheets</i>	33
<i>References</i>	33
Lab 03: Atmospheric Structure and Pressure Systems	35
Leonard Tang	
<i>Pre-Readings</i>	35
<i>Lab Exercises</i>	39
<i>Worksheets</i>	43

Lab 04: Weather Forecasting	45
Terence Day	
<i>Pre-Readings</i>	45
<i>Lab Exercises</i>	49
<i>References</i>	53
Lab 05: Local Climate Data Analysis	55
Terence Day	
<i>Pre-Readings</i>	55
<i>Lab Exercises</i>	56
<i>Worksheets</i>	63
Lab 06: Climate Analysis with Virtual Globes	65
Andrew Perkins	
<i>Pre-Readings</i>	65
<i>Lab Exercises</i>	68
Lab 07: Climate Change and Global Hurricane Tracking	77
Stuart MacKinnon	
<i>Pre-Readings</i>	78
<i>Lab Exercises</i>	78
Lab 08: Atmospheric Moisture and Stability	83
Leonard Tang	
<i>Pre-Readings</i>	83
<i>Lab Exercises</i>	96
<i>Worksheets</i>	99
<i>Supporting Material</i>	100
<i>References</i>	104
Lab 09: Surface Water Budget	105
Gillian Krezoski	
<i>Pre-Readings</i>	105
<i>Lab Exercises</i>	111
<i>Worksheets</i>	115
<i>Supporting Material</i>	115
<i>References</i>	117

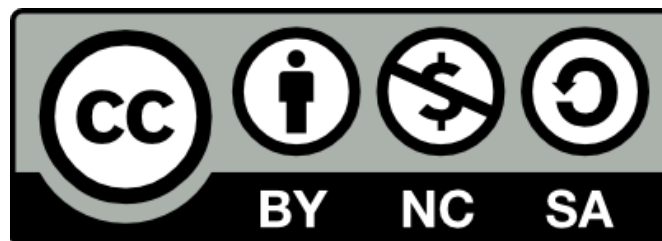
Lab 10: BC Soils and Relationships to Vegetation and Climate	119
Nina Hewitt	
<i>Pre-Readings</i>	119
<i>Lab Exercises</i>	127
<i>Worksheets</i>	141
<i>References</i>	142
Lab 11: Environmental Controls on Biogeography	145
Gillian Krezoski	
<i>Pre-Readings</i>	145
<i>Lab Exercises</i>	149
<i>Supporting Material</i>	153
<i>References</i>	175
Lab 12: Coastal Forest Virtual Field Trip	177
Nina Hewitt	
<i>Pre-Readings</i>	178
<i>Lab Exercises</i>	182
<i>Supporting Material</i>	199
<i>References</i>	199
Lab 13: GPS Orienting	203
Stuart MacKinnon and Craig Nichol	
<i>Pre-Readings</i>	203
<i>Lab Exercises</i>	212
<i>Worksheets</i>	216
Lab 14: Map Skills I - Defining Location	219
Ian Saunders; Chani Welch; and Stuart MacKinnon	
<i>Pre-Readings</i>	219
<i>Lab Exercises</i>	233
<i>Supporting Material</i>	236
Lab 15: Map Skills II - Understanding Direction and Topography	241
Ian Saunders; Chani Welch; and Stuart MacKinnon	
<i>Pre-Readings</i>	241
<i>Lab Exercises</i>	254
<i>Worksheets</i>	257
<i>Supporting Material</i>	258

Lab 16: Measuring and Analyzing Slope	261
Katie Burles and Crystal Huscroft	
<i>Pre-Readings</i>	262
<i>Lab Exercises</i>	267
<i>Worksheets</i>	284
<i>Supporting Material</i>	284
<i>References</i>	287
Lab 17: BC's Geology and Geologic Structures	289
Stuart MacKinnon; Fes de Scally; and Todd Redding	
<i>Pre-Readings</i>	289
<i>Lab Exercises</i>	296
<i>References</i>	305
Lab 18: Volcanoes and Earthquakes	307
Chani Welch; Todd Redding; Stuart MacKinnon; and Fes de Scally	
<i>Pre-Readings</i>	307
<i>Lab Exercises</i>	315
Lab 19: Catchment Analysis	321
Chani Welch and Fes de Scally	
<i>Pre-Readings</i>	321
<i>Lab Exercises</i>	327
<i>References</i>	333
Lab 20: Water Cycle and Water Resources	335
Craig Nichol	
<i>Pre-Readings</i>	335
<i>Lab Exercises</i>	340
<i>Worksheets</i>	351
<i>References</i>	351
Lab 21: Fluvial Geomorphology and Landforms	353
Katie Burles and Crystal Huscroft	
<i>Pre-Readings</i>	353
<i>Lab Exercises</i>	358
<i>Worksheets</i>	365

Lab 22: Alpine Glacial Processes	367
Crystal Huscroft and Katie Burles	
<i>Pre-Readings</i>	367
<i>Lab Exercises</i>	369
<i>Worksheets</i>	381
<i>References</i>	381
Lab 23: Coastal Geomorphology	383
Todd Redding; Stuart MacKinnon; and Fes de Scally	
<i>Pre-Readings</i>	383
<i>Lab Exercises</i>	391
<i>Worksheets</i>	397
<i>References</i>	398
Lab 24: South Okanagan Geomorphology Virtual Field Trip	399
Chani Welch and Todd Redding	
<i>Pre-Readings</i>	399
<i>Lab Exercises</i>	400
<i>Worksheets</i>	408
<i>References</i>	408
About the Authors	411
<i>Katie Burles</i>	411
<i>Terence Day</i>	411
<i>Fes de Scally</i>	412
<i>Nina Hewitt</i>	412
<i>Crystal Huscroft</i>	412
<i>Gillian Krezoski</i>	413
<i>Allison Lutz</i>	413
<i>Stuart MacKinnon</i>	413
<i>Craig Nichol</i>	414
<i>Andrew Perkins</i>	414
<i>Todd Redding</i>	414
<i>Ian Saunders</i>	415
<i>Leonard Tang</i>	415
<i>Chani Welch</i>	415
Versioning History	417

Licensing Information

Laboratory Manual for Introduction to Physical Geography, Second British Columbia Edition (<https://pressbooks.bccampus.ca/geoglabmanualv2>) by Stuart MacKinnon, Chani Welch, Katie Burles, Crystal Huscroft, Nina Hewitt, Gillian Krezoski, Andrew Perkins, Leonard Tang, Terence Day, Craig Nichol, Todd Redding, Allison Lutz, Ian Saunders, and Fes de Scally is licensed under a Creative Commons Attribution-NonCommercial-ShareAlike 4.0 International License (<https://creativecommons.org/licenses/by-nc-sa/4.0/>), except where otherwise noted.



You are free to:

- **Share** — copy and redistribute the material in any medium or format
- **Adapt** — remix, transform, and build upon the material for any purpose, even commercially.

The licensor cannot revoke these freedoms as long as you follow these license terms:

- **Attribution** (https://wiki.creativecommons.org/wiki/Best_practices_for_attribution) — You must give appropriate credit, provide a link to the license, and indicate if changes were made. You may do so in any reasonable manner, but not in any way that suggests the licensor endorses you or your use.
- **NonCommercial** (https://wiki.creativecommons.org/wiki/NonCommercial_interpretation) — You may not use the material for commercial purposes.
- **ShareAlike** — If you remix, transform, or build upon the material, you must distribute your contributions under the same license as the original.

No additional restrictions — You may not apply legal terms or technological measures that legally restrict others from doing anything the license permits.

Cover Photo

The cover photo is of Horsheshoe Glacier by Katie Burle and licensed under a CC-BY-NC-SA 4.0 (<https://creativecommons.org/licenses/by-nc-sa/4.0/>) license.

Images Used with Other Permissions

This text uses many images that are not covered by the CC BY-NC-SA license. Some are included under specific licenses, and others with permission from the author. **Do not use these images unless permission is granted by the author or you meet the conditions of their licenses.**

Government of Canada Terms and Conditions (<https://www.canada.ca/en/transparency/terms.html>)

Lab 03: Atmospheric Structure and Pressure Conditions

Figure 3.2 Surface Analysis Map (https://weather.gc.ca/data/analysis/jac12_100.gif) © Environment Canada (https://weather.gc.ca/index_e.html)

Lab 04: Weather Forecasting

Figure 4.1 Surface Analysis Map (https://weather.gc.ca/data/analysis/947_100.gif) © Environment Canada (https://weather.gc.ca/index_e.html)

Lab 10: BC Soils and Relationships to Vegetation and Climate

Figure 10.3 **Left** Gleysol (<https://soilsofcanada.ca/>) © (<http://sis.agr.gc.ca/cansis/taxa/cssc3/chpt03.html#CANSIS>) Agriculture and Agri-Food Canada (<https://www.agr.gc.ca/eng/agriculture-and-agri-food-canada/?id=1395690825741>)

Figure 10.10 Soil pit in an organic soil from BC (<http://sis.agr.gc.ca/cansis/taxa/cssc3/chpt03.html#CANSIS>) © Soil Classification Working Group

Figure 10.11 Podzolic soil from Quebec on sandy parent materials (<http://sis.agr.gc.ca/cansis/taxa/cssc3/chpt03.html#CANSIS>) © Soil Classification Working Group

Lab 14: Map Skills I

Figure 14.1. NTS 1:50,000 map sheet 82E14 (Kelowna) 4th edition (http://ftp.geogratis.gc.ca/pub/nrcan_rncan/raster/topographic/50k/082/e/14/) © Natural Resources Canada

Figure 14.5 Scale from NTS 1:50,000 map sheet 82N05 (Glacier) 3rd edition (http://ftp.geogratis.gc.ca/pub/nrcan_rncan/raster/topographic/50k/082/n/05/) © Natural Resources Canada

Figure 14.9 Grid Zone Designation from NTS 1:50,000 map sheet 82E14 (Kelowna) 4th edition (http://ftp.geogratis.gc.ca/pub/nrcan_rncan/raster/topographic/50k/082/e/14/) © Natural Resources Canada

Lab 15: Map Skills II

Figure 15.4a. NTS 1:50,000 map sheet 92B06 (Victoria) 6th edition (http://ftp.geogratis.gc.ca/pub/nrcan_rncan/raster/topographic/50k/092/b/06/) © Natural Resources Canada

Figure 15.4b NTS map sheet 01N10 St. John's, NL, 8th edition (http://ftp.geogratis.gc.ca/pub/nrcan_rncan/raster/topographic/50k/001/n/10/) © Natural Resources Canada

Figure 15.5. NTS 1:50,000 map sheet 82N05 (Glacier) 3rd edition (http://ftp.geogratis.gc.ca/pub/nrcan_rncan/raster/topographic/50k/082/n/05/) © Natural Resources Canada

Figure 15.6a. NTS 1:50,000 map sheet 82E14 (Kelowna) 4th edition (http://ftp.geogratis.gc.ca/pub/nrcan_rncan/raster/topographic/50k/082/e/14/) © Natural Resources Canada

Figure 15.6b. NTS 1:50,000 map sheet 92H01 (Ashnola River) 2nd edition (http://ftp.geogratis.gc.ca/pub/nrcan_rncan/raster/topographic/50k/092/h/01/) © Natural Resources Canada

Figure 135.9. NTS 1:50,000 map sheet 82N05 (Glacier) 3rd edition (http://ftp.geogratis.gc.ca/pub/nrcan_rncan/raster/topographic/50k/082/n/05/) © Natural Resources Canada

Lab 17: BC's Geology and Geologic Structures

Figure 17.8. Banff East Cross Section: Map 1294A/1295A (<https://geoscan.nrcan.gc.ca/starweb/geoscan/servlet.starweb?path=geoscan/fulle.web&search1=R=108961>) © Geological Survey of Canada

United States Department of Agriculture

These images are used in accordance with the USDA Digital Rights and Copyright Policy (<https://www.usda.gov/policies-and-links>)

Lab 11: Environmental Controls on Biogeography

Figure 11.6 *Quercus bicolor* © U.S. Department of Agriculture

Figure 11.8 *Quercus chrysolepis* © U.S. Department of Agriculture

Figure 11.11 *Quercus garryana* © U.S. Department of Agriculture

Figure 11.13 *Quercus laurifolia* © U.S. Department of Agriculture

Figure 11.15 *Quercus macrocarpa* © U.S. Department of Agriculture

Figure 11.17 *Quercus phellos* © U.S. Department of Agriculture

Figure 11.19 *Quercus rubra* © U.S. Department of Agriculture

Figure 11.21 *Quercus virginiana* © U.S. Department of Agriculture

Google Earth and Google Maps

The following screen captures from Google Earth and Google Maps are used in accordance with Google's guidelines (<https://www.google.com/permissions/geoguidelines/>).

Lab 10: BC Soils and Relationships to Vegetation and Climate

Figure 10.4a Soils of BC Instructional Tour © Google

Figure 10.4b Soils of BC Instructional Tour © Google

Figure 10.5 Soils of BC Instructional Tour © Google

Figure 10.12 Google Earth Web Tour at Site #4 © Google

Lab 15: Map Skills II

Figure 15.10. Google Earth topographic profile near Glacier, BC, Canada © Google

Lab 16: Measuring and Analyzing Slope

Figure 16.9 Example EX1.6 Google Earth Horizontal distance measurement © Google

Figure 16.10 Example EX2.1. Google My Map screenshot of black diamond ski run © Google

Lab 21: Fluvial Geomorphology and Landforms

Figure 21.3 Google Earth screen capture © Google

Lab 22: Alpine Glacial Processes

Figure 22.1 Sample Figure EX1.1 © Google

Figure 22.3 Sample Figure EX1.3 © Google

Figure 22.4 Sample Figure EX1.4 © Google

Figure 22.5 Sample Figure EX2.2 © Google

Figure 22.6 Sample Figure EX2.3 © Google

Figure 22.8 Sample Figure EX2.5 © Google

Lab 23: Coastal Geomorphology

23.5 Google Earth Image of James Island © Google

23.6 Google Earth Image of Coastal Landforms Near Tofino © Google

Climate BC Map (Lab 10: BC Soils)

Screen captures from Climate BC Map are used with permission from Tongli Wang:

Figure 10.6 Climate BC Website © University of British Columbia

Figure 10.7 Climate BC Website © University of British Columbia

Figure 10.8 Climate BC Website © University of British Columbia

Figure 10.9 Climate BC Website © University of British Columbia

iMapBC

The copyright for iMapBC content is held by the Province of British Columbia with all rights reserved. For this project, permission was granted by the Province of British Columbia to reproduce images. Adaptations and reproductions of this content may require special permission.

Lab 16: Measuring and Analyzing Slope

Figure 16.11 Example EX2.2. iMap screen capture of ski run named Fuzzy at Kimberley Alpine Resort © DataBC, Province of British Columbia

Figure 16.12 Example EX2.3. Four natural slope breaks along the ski run Fuzz at Kimberley Alpine Resort © DataBC, Province of British Columbia

Lab 20: Water Cycle and Water Resources

Figure 20.1 iMap screen capture of the location of Nicomekl River Watershed © DataBC, Province of British Columbia

Figure 20.7 iMap screen capture of the Water usage within the Nicomekl watershed © DataBC, Province of British Columbia

Pacific Northwest Seismic Network (PNSN) (Lab 18)

Screenshots from the Pacific Northwest Seismic Network are used with permission. Anyone wishing to adapt or reproduce these images may wish to verify that the permission still applies to their new work.

Figure 18.3 Epicentres of notable earthquakes in the Pacific Northwest from 1997 to 2019 (<https://pnsn.org/earthquakes/notable>) © Pacific Northwest Seismic Network (<https://pnsn.org/>)

Figure 18.4 Cross-section showing depth and magnitude of notable earthquakes (<https://pnsn.org/earthquakes/notable>) © Pacific Northwest Seismic Network (<https://pnsn.org/>)

BC Watertool (Lab 20)

BC Watertool screenshots contain mapping information from DataBC (<https://data.gov.bc.ca/>) that is licensed under an All Rights Reserved (<https://choosealicense.com/no-license/>) license. Permission for use has been provided by the Province of British Columbia. If re-using this content in a different application, or redistributing it, separate permission may be required.

Figure 20.2 Precipitation data from White Rock climate station 1108910 © Foundry Spatial

Figure 20.3 Streamflow in Nicomekl River at Station 08MH155 © Foundry Spatia

Figure 20.4 Groundwater levels at BC Obs Well 353 © Foundry Spatial

Other Terms of Use

Figures 3.1, 3.2, and 3.4: Permission has been granted by EarthWindMap (<https://earth.nullschool.net/>) for licensing of these images as CC BY-NC-SA 4.0.

Figure 10.3 **right** Soil ped with mottles © Weil and Brady is reproduced with permission from R. Weil and Pearson Education.

Figure 15.11. Bitterroot Loop clipped from Rose Valley Regional Park kiosk information (<https://www.regionaldistrict.com/your-services/parks-services/parks-and-trails/12-rose-valley-regional-park.aspx>) © Regional District of Central Okanagan is used with permission

Territorial Acknowledgements

As a collaboration of post-secondary instructors from across the province of British Columbia (BC), the fourteen authors of the first and second edition of this lab manual live and work on numerous unceded Indigenous territories. We would like to begin this lab manual with the following institutional territorial acknowledgements.

University of British Columbia (Stuart MacKinnon, Nina Hewitt, Craig Nichol, Ian Saunders, and Fes de Scally)

The University of British Columbia (UBC) has two campuses, one in the Okanagan and one in Vancouver, and this lab manual has authors representing both campuses. On behalf of UBC, we acknowledge that our Okanagan Campus is located on the traditional, ancestral, and unceded territory of the Syilx Okanagan Nation, and the Vancouver Campus is located on the traditional, ancestral, and unceded territory of the x^wməθk^wəyəm (Musqueam) people.

Okanagan College (Chani Welch, Terence Day, and Todd Redding)

On behalf of Okanagan College, we acknowledge that our Penticton, Kelowna, and Vernon campuses are located on the traditional and unceded territory of the Syilx (Okanagan) people, and our Salmon Arm campus is located on the traditional and unceded territory of the Secwepemc (Shuswap) people.

College of the Rockies (Katie Burles)

On behalf of College of the Rockies, I acknowledge that our main campus is located on the traditional and unceded territory of the Ktunaxa and Kinbasket people.

Thompson Rivers University (Crystal Huscroft)

On behalf of Thompson Rivers University, I would like to respectfully acknowledge that our main campus is on the unceded territory of the Tk'emlúps te Secwépemc within Secwépemc'ulucw.

University of Victoria (Gillian Krezoski)

On behalf of the University of Victoria, I acknowledge and respect the lək^wəŋən peoples on whose traditional territory the university stands, and the Songhees, Esquimalt and WSÁNEĆ peoples whose historical relationships with the land continue to this day.

Simon Fraser University (Andrew Perkins)

On behalf of Simon Fraser University, I respectfully acknowledge the Sḵwəxwú7mesh Úxwumixw (Squamish), səlilwətaʔ (Tsleil-Waututh), x^wməθk^wəyəm (Musqueam), k^wik^wəłəm (Kwkwetlem), Kwantlen, qíćəy (Katzie), Qayqayt, Semiahmoo and Tsawwassen peoples on whose traditional, unceded territories our three campuses reside.

Langara College (Leonard Tang)

On behalf of Langara College, I would like to acknowledge that our location resides on the unceded traditional territory of the x^wməθk^wəyəm (Musqueam) First Nation.

Selkirk College (Allison Lutz)

On behalf of Selkirk College, I acknowledge that we operate and serve learners on the unceded traditional territories of the Sinixt (Lakes), the Syilx (Okanagan), the Ktunaxa, and the Secwepemc (Shuswap) peoples.

Thank you to all of these Indigenous people for the continued stewardship of the land on which we all live and rely upon. We would also like to acknowledge that colleagues who reviewed these labs also live and work on these, and other, Indigenous territories across BC. Finally, we would like to acknowledge all Indigenous territories across BC, Canada, and the world where this lab manual may be used.

Contribution Acknowledgements

As editor and coordinator of this project, Stuart MacKinnon would like to start by acknowledging all the time and effort that was contributed by the fourteen authors of this lab manual. We were able to put together the first edition of this lab manual on such a short timeframe only because of this dedication.

The fourteen authors of this lab manual are grateful to the following colleagues from British Columbian institutions who dedicated their time as subject matter experts and lab reviewers: Bernard Bauer, Wendy Hales, Trish Jarrett, Sarah Peirce, Matteo Saletti, and Stuart Toop. Nina Hewitt from UBC would like to thank Kelly Hurley for video editing assistance and Greg Henry for background context that guided lab 12. More broadly, we would like to acknowledge the BC Geography Articulation community for the encouragement during the project, and for setting the stage from which this entire project started. Also, we would like to thank Erin Fields and Amanda Grey for the essential librarian, copyright, and Pressbook support that was provided throughout summer 2020. The first edition of the lab manual could not have come together without the two of you. We are also appreciative to all the instructors who are, and will be, using this lab manual for any continual feedback they provide.

For the creation of the second edition of the lab manual, we would like to thank Chani Welch and Karla Panchuk for their work on the revisions. Specifically, we would like to recognize Chani Welch for her time editing the labs and instructor notes for content, consistency, and effectiveness; and we would like to recognize Karla Panchuk for her time reviewing all the first edition labs and for her editorial support based on her instructor-based Pressbook expertise. We would also like to acknowledge Katharina Holt for her diligent work identifying and addressing accessibility considerations throughout the lab manual.

Preface

After the intense instructional period that resulted from post-secondary institutions across British Columbia (BC) shifting immediately to online delivery in March 2020 for the remainder of the academic semester, many instructors started thinking forward towards the upcoming academic year under similar requirements. Katie Burles and Crystal Huscroft were two such instructors who initially envisioned the idea of sharing ideas, materials, and labs between instructors across BC. Using the BC geography articulation group, Katie organized a series of video meetings of geography instructors across the province starting in early May to discuss ways of delivering geography online and the potential of sharing teaching resources. As these meetings continued, and more instructors were invited into the group, the idea of a collaborative open educational resource lab manual surfaced. After some discussion, Stuart MacKinnon stepped forward to coordinate this effort. In addition to Stuart, 13 other authors stepped forward to volunteer their time and produce new labs for online delivery, and the lab manual project began at the end of May. In only 3 months, 22 labs and a tutorial were created, reviewed by additional BC geography instructors, and the first edition of this Pressbook lab manual for use during the 2020/21 academic year was created with the assistance of UBC librarian support. The second edition of this lab manual was released for the start of the 2021/22 academic year and featured substantial structural and editorial revisions, along with two new labs. This lab manual could not have come together without the dedicated support of many individuals from across BC, and it is an excellent example of the collaboration that is possible when committed instructors come together.

Accessibility Statement

The post-secondary instructors from across British Columbia who collaborated to create this lab manual believe that education needs to be available to everyone, which means supporting the creation of free, open, and accessible educational resources. We are actively committed to increasing the accessibility and usability of the textbooks and lab manuals we produce.

Accessibility features of the web version for this resource

The web version of the Laboratory Manual for Introduction to Physical Geography, Second British Columbia Edition (<https://pressbooks.bccampus.ca/geoglabmanualv2>) has been designed with accessibility in mind by incorporating the following features:

- It has been optimized for people who use screen-reader technology:
 - all content can be navigated using a keyboard
 - links, headings, tables, and images have been designed to work with screen readers
- It has the option to increase font size (see tab on top right of screen).

Other file formats available

In addition to the web version, this book is available for download in a number of file formats, including EPUB, Digital PDF, Print_pdf, and MOBI.

Known accessibility issues and areas for improvement

While we strive to ensure that this lab manual is as accessible and as usable as possible, we might not always get it right. Any issues we identify will be listed below.

Location of Issue (link)	Need for improvement	Timeline	Work around

Accessibility standards

The web version of this resource has been designed to meet Web Content Accessibility Guidelines 2.0 (<https://www.w3.org/TR/WCAG20/>), level AA. In addition, it follows all guidelines in the BCcampus Open Education Accessibility Toolkit (2nd edition) – Appendix A: Checklist for Accessibility (<https://opentextbc.ca/accessibilitytoolkit/back-matter/appendix-checklist-for-accessibility-toolkit/>).

Let us know

We are always looking for how we can make this resource more accessible. If you are having problems accessing this resource, please contact us to let us know so we can fix the issue.

Please include the following information:

- The location of the problem by providing a web address or page description
- A description of the problem
- The computer, software, browser, and any assistive technology you are using that can help us diagnose and solve your issue
 - e.g., Windows 10, Google Chrome (Version 65.0.3325.181), NVDA screenreader

Please contact either of the editors of this lab manual to let us know:

- Stuart MacKinnon: stuart.mackinnon@ubc.ca (<mailto:stuart.mackinnon@ubc.ca>)
- Chani Welch: cwelch@okangan.bc.ca (<mailto:cwelch@okangan.bc.ca>)

This statement was last updated on August 27, 2021.

This accessibility statement was adapted from the BCcampus Open Education Accessibility Toolkit (2nd edition) – 11. Accessibility Statements (<https://opentextbc.ca/accessibilitytoolkit/chapter/accessibility-statements/>).

Tutorial: Using Spreadsheets in Geography

Craig Nichol

The spreadsheet tutorial is built within excel (first link below). Download the file below and complete the tutorials (tabs within the excel spreadsheet) **as instructed by your instructor**.

- Spreadsheet Tutorial [Excel] (<https://pressbooks.bccampus.ca/geoglabmanualv2/wp-content/uploads/sites/1340/2021/08/Spreadsheet-Tutorial-Excel.xlsx>)
- Spreadsheet Tutorial [ODS] (https://drive.google.com/file/d/1xO0luqBgyQM2lw5I7ke0i0_M2zUZId0h/view?usp=sharing)

Lab 01: Earth Systems and Earth's Four Spheres

Allison Lutz

Making observations of the landscape is an essential component of geography. This lab will connect you with the geography of the place in which you live. It is an important skill to describe the natural and anthropogenic features of the landscape, and to consider ways in which a change in one aspect may affect all others. It is only as we seek to understand the interconnectedness of Earth spheres and systems that we will find appropriate solutions to our global environmental issues.

Learning Objectives

After completion of this lab, you will be able to

- Orient a map to the landscape.
- Draw a simple sketch map.
- Name and identify natural and built features of the local area.
- Observe and record characteristics of the local atmosphere, lithosphere, hydrosphere, and biosphere.
- Describe the anthropogenic impacts on natural systems.
- Examine examples of positive and negative feedback systems at work.
- Describe potential changes to natural systems.

Pre-Readings

To complete this lab, you will need background information on geographic approaches and themes, drawing sketch maps, Earth spheres, and systems theory. A brief summary is provided here. These topics are typically covered in Chapter One of first-year geography textbooks. Use the textbook's index to find these topics, then read about them if you require more detailed information.

Geographic Approaches and Themes

Textbooks may vary on the exact terms used to describe geographic approaches and themes. Central to the study of physical geography is the approach of a **spatial analysis**, and the concept that there is a natural world that is impacted by human activities. Humans are in turn influenced by natural systems. Monitoring, striving to understand, and mitigating environmental change is a key aspect of physical geography

Earth Spheres

Our natural environment can be broken down into four spheres. Keep in mind, however, that these subdivisions are artificial and that in reality there is constant and considerable interaction and overlap between all spheres.

The **hydrosphere** consists of water in all its forms (solid, liquid, and gas; fresh and salty), as it appears at or near the Earth's surface. It includes oceans, rivers, lakes, springs, glaciers and ice caps, shallow groundwater, and atmospheric water vapor.

The **atmosphere** is a mixture of gases, forming an envelope around the Earth, and held in place by gravity. Up to an altitude of about 80 km the composition is nearly constant at 21% oxygen, 78% nitrogen, and traces of argon, xenon and krypton. In addition, there are variable quantities of carbon dioxide, methane, and water. We are most interested in the **troposphere**, the lower 18 km where weather and climate are determined.

The **lithosphere** is the upper mantle and the Earth's crust that create landscape features such as mountains and valleys.

The **biosphere** includes all living things and their physical environment. It extends from several kilometers below the sea floor to about 8 km above the surface and requires the presence of water as well as an energy source of some kind. The range for individual species within the biosphere can change as local conditions within the other spheres change (Christopherson, R.W. & Byrne M.L., 2015).

Systems Theory and Feedback Loops

A **system** is any ordered, interrelated set of things and their attributes, linked by flows of energy and matter. A system is in some way distinct from its surrounding environment; for example, a watershed is an identifiable system. Systems are described as **open** if they are receiving inputs and providing outputs of matter and energy. A system is described as **closed** if it receives inputs and outputs of energy but not matter. Very few systems are truly closed

If a system is at **steady state**, it will fluctuate around conditions which are considered normal for that system. This is known as dynamic equilibrium. Feedback loops govern the response of a system to change. Feedback loops may be either **negative** (maintain equilibrium), or **positive** (lead to a new equilibrium). For example, consider seasonal variability in water level in a stream. Normally, the water level is low enough to wade across. During snow melt, the water level will increase because of the extra water being added from the melting snow, but the water levels will drop again once that snow has disappeared, and temperatures rise. This correction or return to normal conditions is a **negative feedback loop**. If a system moves out of its steady state, or out of equilibrium and a system continues in that direction then the system is said to be in a **positive feedback loop**. Many global changes that are occurring as a result of climate change, such as the melting of polar icecaps, are in positive feedback loops. Eventually the system will find a new equilibrium.

Lab Exercises

In this introductory geography lab you will become familiar with the local geography and begin to think like a geographer.

This lab includes three exercises that result in creating an assignment to be handed in as a report in PDF format. The submitted report will include a series of figures with captions. The entire lab will take approximately 2 hours to complete.

Exercise 1 is mostly field-based, whereas Exercises 2 and 3 are office-based. You will need to allow for travel time (walking, biking, public transit, driving etc.) to your field site for Exercise 1. The field sketch (see Worksheets for a blank sketch map template) should take approximately half an hour to complete. The rest of the lab will take the remaining time.

Contact your instructor for an alternative approach to these exercises if you are experiencing mobility or visual constraints.

Required materials:

- Camera (cell phone is fine).
- Pencil, clipboard, and some blank pieces of paper to sketch on.

Required software:

- Google Maps
- Word processing software (Word, Google Docs)

EX1: Field Sketch

Step 1: Select Your Location

Start by opening Google Maps on your phone or computer. Zoom into the area you will be viewing in the field. If you are on a desktop computer you will need to print the map, otherwise refer to the map on your phone or tablet while in the field. It will be helpful to watch Video 1.1:

Video 1.1. Orienting a map to the landscape. Closed captions and transcript available on Youtube (<https://www.youtube.com/watch?v=va5l8rE9yPc>).



One or more interactive elements has been excluded from this version of the text. You can view them online here: <https://pressbooks.bccampus.ca/geoglabmanualv2/?p=36#oembed-1> (#oembed-1)

Identify a safe and easily accessible place where you can view the landscape from above, and make and

record your observations. Examples of viewpoints (also known as overlooks) include a hillside, bridge, or tall building – your instructor can suggest locations. When you go to the field you will need to bring

- camera (cell phone is fine)
- clipboard, some blank pieces of paper, and a pencil, and
- a digital or printed copy of the lab exercises.

Ahead of your departure read through the Lab Exercises.

Safety: Do not complete the remainder of this exercise until receiving a safety briefing and filling the proper paperwork (if applicable) from your lab instructor. In addition, your first goal when you arrive at a site is to ascertain whether the terrain is safe.

Step 2: Orient Your Map

Once you have arrived at your chosen viewpoint you will need to orient your map to your location. Open the map on your phone or tablet or pull out the paper copy of the map.

- Find your location on the map. If you are on Google Maps this is easily done by pressing the small arrow. Zoom in or out to view the map at a scale that reflects what you can see in the landscape.
- Find features on the map that are evident in the surrounding terrain.
- Turn your map (phone) so that the features in front of your view match the features on your map.
- Assuming north is at the top of your map, determine where north is relative to the direction you are facing.

Step 3: Frame Your Field Sketch (Figure EX1.1)

You may be new to this area of British Columbia or you may have lived here your entire life; regardless, you can build your geographic literacy by being able to name and describe the natural and built features of the surrounding landscape.

Find a suitable viewpoint and spend a few moments observing the landscape (see Figure 1.1).

Decide on an area that is appropriate to capture in your sketch. It may be a valley bottom with a river running through it or you could narrow in on a smaller area such as your neighbourhood. **The sketch will be from above, a bird's eye view or map view.**

Photograph the landscape from your position. With annotation, this photograph will become Figure EX1.1 in your lab report (see example Figure 1.2).



Figure 1.1. Student stands at a viewpoint on grassy hill overlooking the confluence of the Kootenay River and Columbia River.
Source: A. Lutz, CC BY-NC-SA 4.0.



Figure 1.2. Example Figure EX1.1. Looking south over Castlegar Valley from Brilliant Terraces. The area for the sketch map is identified with a rectangle. Source: A. Lutz, CC BY-NC-SA 4.0.

Step 4: Create Your Field Sketch (Figure EX1.2)

Sketch a map of the area you identified. You do not need to be an artist to complete a field sketch. The best maps are simple with clearly defined lines. A sheet is provided for your sketch in Worksheets (**Blank Sketch Map**).

The following are important elements to consider as you draw your map. Refer to Figure 1.3 for a sample sketch map.

- **Clearly define the boundaries or edges of your map.** Mountains, watersheds, shorelines, roads and railways tend to define our vision and are commonly used as edges. The scale of a sketch is determined by the objects in view and the amount of detail required to be shown. Determine how much area you want to draw. From the viewpoint, the area in the rectangle on Figure 1.2 was selected for the sketch map.
- **Identify pathways or routes which dissect your selected area** such as roads, trails, rivers, streams, power lines. We generally experience our surroundings as we move along these routes. Show direction of travel of rivers with an arrow.
- **Identify any significant junction points where important pathways come together.** The confluence (meeting) of two streams, the intersection of two roads.
- **Identify polygons or districts.** These are small areas with a common feature, such as urban areas, single family housing, parks, open fields, changes in vegetation type (from leaf bearing/deciduous to needle bearing/coniferous) etc.
- **Identify any significant landmarks** that are distinctive because of their height, shape, or historical significance. An example might be a well-known mountain peak, a waterfall, a statue, a mall. (Lynch,1960)
- On your map you must also include
 - title/location,
 - date,
 - your name,

- legend (symbols which indicate vegetation type, mountains, urban areas),
- north arrow, and
- approximate scale. Relate the scale to a dimension of your sketch map, as done on Figure 1.3.

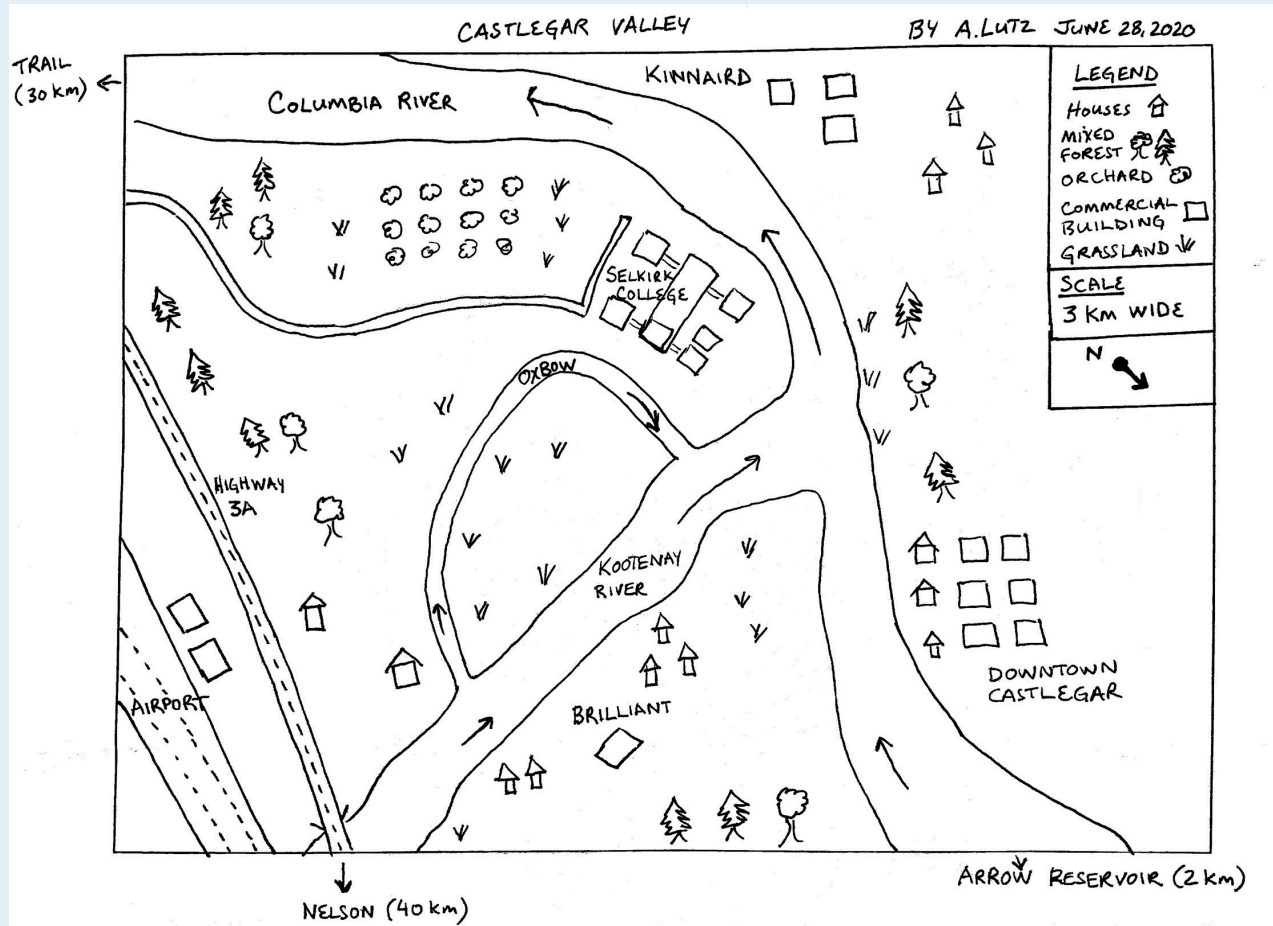


Figure 1.3. Example Figure EX1.2. Sketch map of rectangle area from Figure 1.2. Source: A. Lutz, CC BY-NC-SA 4.0.

Photograph your sketch map before leaving the field.

Step 5: Document Your Field Work (Figure EX1.3)

Take a selfie (photograph of yourself) at the field site holding your field sketch.

Step 6: Create the EX1 Portion of Your Lab Report

Once you are back home, open a Word document on your computer, and create a title page for your lab report that includes the title of this lab assignment, your name, lab section, and date.

Create the EX1 portion of your lab report by inserting the title **Exercise 1: Field Sketch** and insert the figures you created in the field:

1. Figure EX1.1: Frame of your field sketch. Insert the photo as a picture, and add a rectangle to indicate the boundary of your field sketch.
2. Figure EX1.2: Field sketch. Insert the photo of your field sketch.

3. Figure EX1.3: Documentation of field work. Insert your selfie.

Add descriptive captions to each figure to complete this portion of the report.

EX2: Earth Spheres

Create a new section of your lab report titled **Exercise 2: Earth Spheres**. Copy Table 1.1 below and paste into your lab report. The table is also available in Worksheets (Lab 01 Table 1.1).

Using the map, local knowledge, and if needed, a computer search, identify local characteristics of the hydrosphere, atmosphere, lithosphere and biosphere, and anthropogenic impacts. Complete the table with

- **Landscape features:** identify two to four features for each sphere. Describe each feature with, for example, size, location and significance; and
- **Anthropogenic impacts:** describe ways in which the sphere has been altered by humans. Be specific.

Your answers may pertain to the area in general and need not be restricted to the area represented by your field map.

Table 1.1. Identifying Spheres, Their Characteristics, and Anthropogenic Impacts

Sphere	Task Description	Landscape Features	Anthropogenic Impacts
Hydrosphere	Name oceans, streams, lakes, wetlands, bogs, and provide a description of relative size and significance in the landscape.		
Atmosphere	Describe characteristics of local weather and climate (e.g., consider seasons, temperature range, climatic changes).		
Lithosphere	Name geomorphological features (e.g., mountains, valleys, plateaus, terraces, floodplains).		
Biosphere	Describe vegetation types (e.g., coniferous*, deciduous**, grasslands, shrubs, mosses), spatial extent and distribution (e.g., dense, sparse, regular, irregular), aspect (i.e. direction slope faces).		

*Coniferous tree is a needleleaf tree that bears cones

**Deciduous tree is a leaf-bearing tree that sheds its leaves seasonally

EX3: Systemic Change

We are living through an era of rapid environmental change. Consider ways in which a change in one sphere may affect all others in your area. Point form is acceptable.

1. Specific to the landscape you are observing, describe how a catastrophic (very large) wildfire might impact each sphere. Consider both the immediate impacts and long-term impacts. List 4-7 impacts.
2. Identify one specific change created by the wildfire and discuss whether it is a positive or negative feedback loop. Describe in 2-3 sentences.
3. Depending on whether hydrological dams exist in your area, consider how either putting in a dam or removing dams (if they already exist) might impact local spheres and alter the entire watershed system. List 4-7 impacts.
4. Describe how a pandemic lockdown has impacted human activities and how it may have altered each of Earth's spheres in your area or on a global scale. Provide two examples of how it has altered. Limit your answer to 4-8 sentences.

Create a new section of your lab report titled **Exercise 3: Systemic Change** and type in your answers.

Reflection Questions

1. Now that you have completed a field sketch, describe how this process differs from simply printing a map or taking a photograph. (1-2 sentences)
2. What information could be conveyed on a field sketch that is not available on photographs, remotely sensed images or a map? (3 sentences)
3. Describe **the sense of place** this area has for you; this will be different for each student depending on your life experiences. For example, are you connected to this landscape? Are you concerned or optimistic about how the landscape is changing? Try to be honest here, do not write what you think your instructor is looking for. (3-5 sentences)

Create a new section of your lab report titled **Reflection Questions** and type in your answers.

Report Submission

Once all exercises are complete, save the assignment as a PDF and submit as directed by your instructor.

Worksheets

Blank Sketch Map

- Sketch Map [Word] (<https://pressbooks.bccampus.ca/geoglabmanualv2/wp-content/uploads/sites/1340/2021/03/Sketch-Map.docx>)
- Sketch Map [ODT] (<https://pressbooks.bccampus.ca/geoglabmanualv2/wp-content/uploads/sites/1340/2021/03/Sketch-Map.odt>)
- Sketch Map [PDF] (<https://pressbooks.bccampus.ca/geoglabmanualv2/wp-content/uploads/sites/1340/2021/03/Sketch-Map.pdf>)

EX2 Table 1.1

- Lab 01 Table 1.1 [Word] (<https://pressbooks.bccampus.ca/geoglabmanualv2/wp-content/uploads/sites/1340/2020/05/Lab-01-Table-v1.docx>)
- Lab 01 Table 1.1 [ODT] (<https://pressbooks.bccampus.ca/geoglabmanualv2/wp-content/uploads/sites/1340/2020/05/Lab-01-Table-v1.odt>)
- Lab 01 Table 1.1 [PDF] (<https://pressbooks.bccampus.ca/geoglabmanualv2/wp-content/uploads/sites/1340/2020/05/Lab-01-Table-v1.pdf>)

References

Christopherson, R.W. & Byrne M.L. (2015). *Geosystems: An introduction to physical geography* (Canadian 4th ed.). Prentice-Hall Inc.

Lynch, K. (1960). *The image of the city*. MIT Press.

Media Attributions

- Orienting a map to the landscape (<https://www.youtube.com/watch?v=va5l8rE9yPc>) by Trail magazine (<https://www.youtube.com/@trailmagazine>) is licensed under a Standard YouTube License.

Lab 02: Earth-Sun Relationships and Earth's Energy Budget

Andrew Perkins

Most of Earth's energy comes from the sun. This energy is what drives the function of many Earth systems. Understanding how this energy makes its way to the Earth and interacts with the atmosphere and surface is a big part of understanding how the Earth works.

Learning Objectives

After completion of this lab, you will be able to

- Measure how Earth relates to the sun at different times of the year at different latitudes.
- Convert between several common temperature scales.
- Predict how temperature will generally change with latitude.
- Assess how local variables like cloud cover, aspect and surface albedo affect local radiation balance.

Pre-Readings

In order to complete this lab, some background information on Earth-sun relationships, Earth's energy budget, common temperature scales, albedo, and aspect is required.

Earth-Sun Relationships and Earth's Energy Budget

Energy Inputs

Earth is dependent on the sun's energy to support almost all of the systems at work. The actual amount of energy received at the Earth's surface at any specific location is dependent on three components:

1. The **solar constant** (approximately 1367 watts/m^2) is the amount of solar energy received at the top of the atmosphere. This changes slightly with solar output.
2. The angle of the sun's rays compared to the surface of the Earth. This changes with the seasons.
3. Atmospheric composition. The state of the atmosphere – for example, how much water vapour is present above that location – is variable.

We are all aware that the quantity of sunlight varies over time and space. Over a 24-hour period, we know that sunlight is generally strongest around noon and nonexistent during the time of day we call night. **Insolation** (incoming solar radiation) can be defined as the solar radiation or sunlight that is received by the Earth's ground surface or atmosphere. Many locations on our planet experience yearly variations in the quantity of insolation. If these variations are large enough, they contribute to the annual march of the seasons.

Reading: Incoming Sunlight [PDF] (<https://pressbooks.bccampus.ca/geoglabmanualv2/wp-content/uploads/sites/1340/2020/05/Incoming-sunlight-NASA.pdf>)

This short article explains how Earth's tilt and surface reflectivity impact how insolation behaves as it encounters the Earth. The same information is available on the NASA Earth Observatory website. (<https://earthobservatory.nasa.gov/features/EnergyBalance/page2.php>)

The latitude at which the sun is directly overhead at noon is called the **latitude of the subsolar point**. The sun is directly overhead of the equator at noon on the equinoxes. It is directly overhead of the Tropic of Cancer at noon on the June solstice, and directly overhead of the Tropic of Capricorn at noon on the December solstice. In between these dates, you can determine the latitude of the subsolar point using a diagram called the **analemma** (Figure 2.1).

Reading the analemma is a three-step process:

Step 1: On the figure-8 shape, find the date for which you want to know the latitude of the subsolar point.

Step 2: Read across to the vertical axis on the left side of the analemma and read the latitude. **Note: latitudes only go up to a maximum 23.5°, the latitude of the Tropic of Cancer and Capricorn, as the sun is never directly overhead at higher latitudes.**

Step 3: The analemma is split into the northern hemisphere (upper half, above 0°) and southern hemisphere (lower half, below 0°). Determine whether the latitude of the subsolar point is in the northern hemisphere or the southern hemisphere.

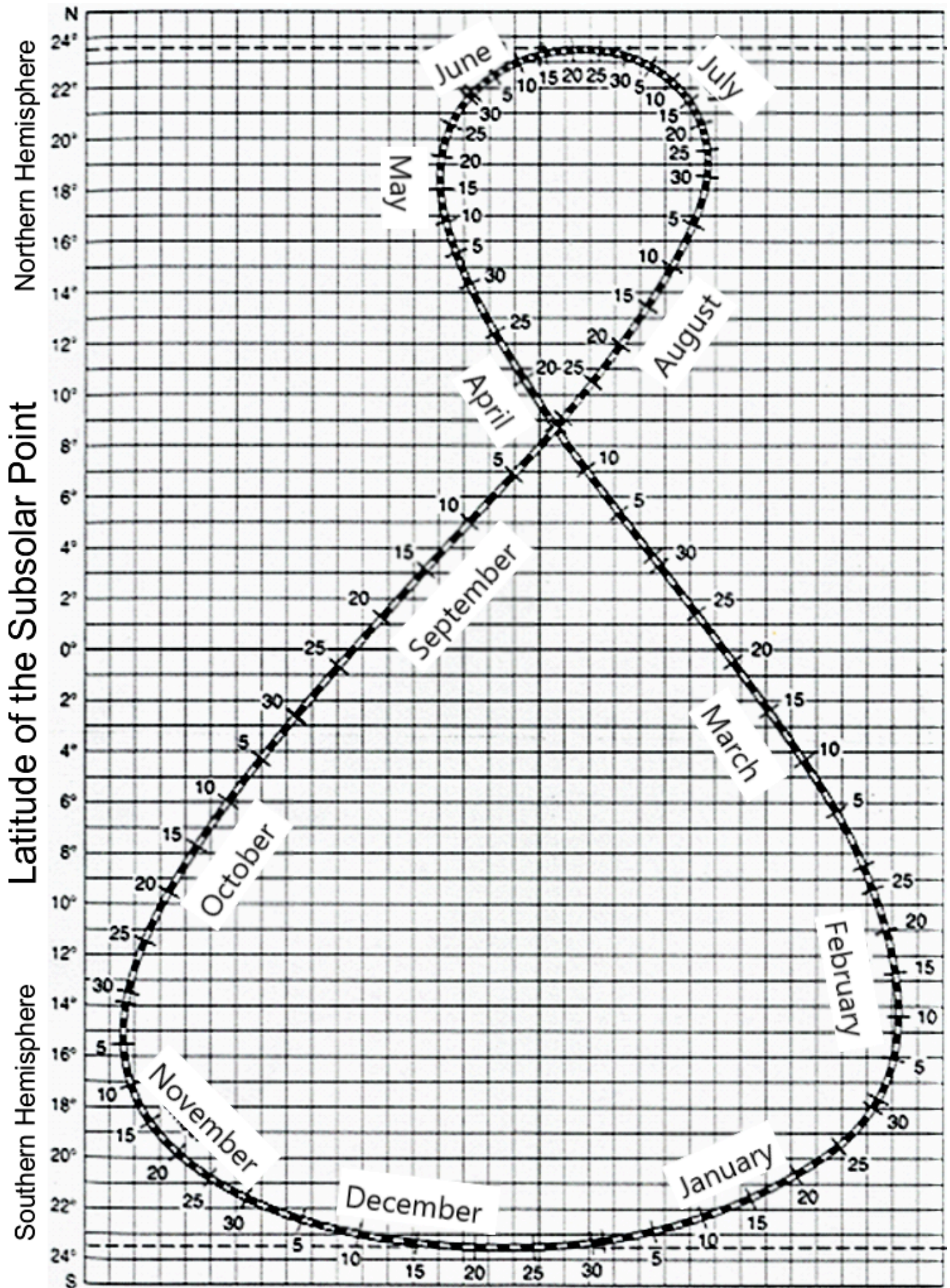


Figure 2.1. Analemma diagram. This diagram is used to determine the latitude of the subsolar point based on calendar date. Source: Modified by A. Perkins and C. Welch, CC BY-NC-SA 4.0. Modified from US Coast and Geodetic Survey, Public Domain.[Image description]

The March of the Seasons and the Angle of the Noon Sun

Across the range of latitudes, locations near the Equator receive high quantities of insolation all year long. Locations near the poles only receive significant amounts of insolation during a relatively short summer period. For this reason, localities near the poles have cold winter conditions during most of the year.

Reading: Heating Imbalances [PDF] (<https://pressbooks.bccampus.ca/geoglabmanualv2/wp-content/uploads/sites/1340/2020/05/Heat-Imbalances-NASA.pdf>)

This short article describes how Earth's tilt and surface reflectivity impact heating imbalances across Earth and drive atmospheric and oceanic circulation on Earth. The same information is available on the NASA Earth Observatory website. (<https://earthobservatory.nasa.gov/Features/EnergyBalance/page3.php>)

The angle at which solar radiation encounters the Earth's surface is important for how that energy is distributed. The **angle of the noon sun (ANS)** is calculated using Equation 2.1:

Equation 2.1

$$\text{ANS} = 90^\circ - (\text{Latitude} \pm \text{Latitude of the Subsolar Point})$$

where

- ANS = the angle of the noon sun (expressed in degrees)
- Latitude = the desired location on the surface of the Earth
- Latitude of the subsolar point (LSP) = the latitude where the sun is directly overhead for that date of the year.

Examples of how to calculate the difference between latitude for your location and the LSP are presented in Figure 2.2 for three scenarios. Important points to take note of:

- You are interested in the total difference in latitude between our location and the LSP.
- You cannot have a sun angle greater than 90° .
- When determining whether you should add or subtract the LSP **within Equation 2.1 specifically**, consider which hemisphere you are in, and whether it is the "summer half" of the year (location is tilted towards the sun) or the "winter half" of the year (location is tilted away from the sun). If you are in the "summer half" of the year (i.e., approximately March 23 – September 20 in the Northern Hemisphere), then you subtract the LSP in Equation 2.1. If

you are in the “winter half” of the year (i.e., approximately March 23 – September 20 in the Southern Hemisphere), then you add the LSP in Equation 2.1.

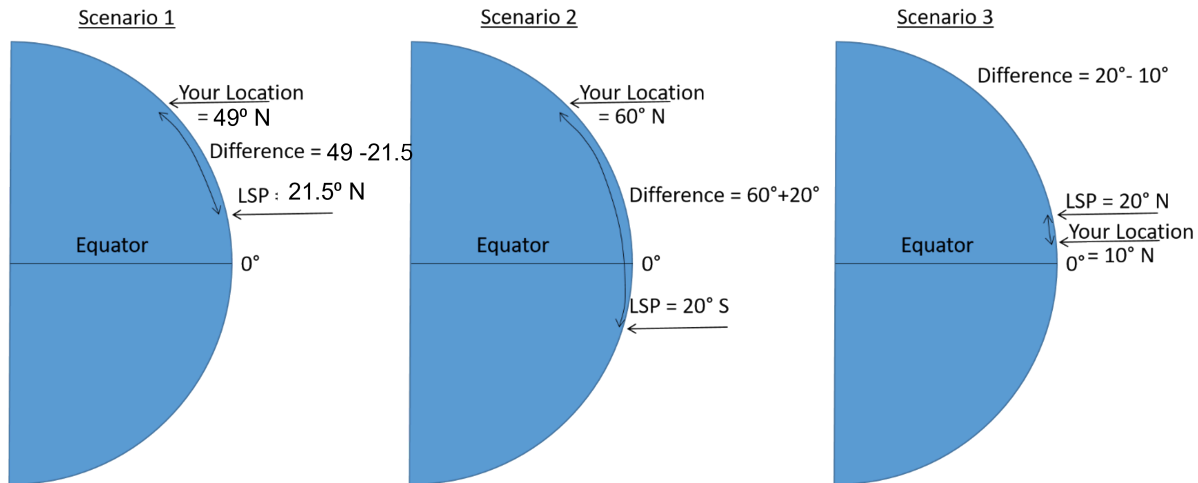


Figure 2.2. Scenarios for calculating angle of the noon sun, based on varying positions of latitude and LSP. In Scenario 1, you are in the Northern Hemisphere and it is the “summer” half of the year so you subtract the LSP. In Scenario 2, you are in the Northern Hemisphere and it is the “winter” half of the year so you add the LSP. In Scenario 3, you are in the Northern Hemisphere and it is the “winter” half of the year so you subtract the LSP. Because Scenario 3 is within 23.5 degree of the equator, you have to account for this by either flipping the location and LSP (when calculating the difference), or adding (180 -) to the start of Equation 2.1. Source: A. Perkins, CC BY-NC-SA 4.0.

Let us assume that we are located at 49° N on July 14. From the analemma in Figure 2.1 we determine that the LSP is 21.5° N. ANS may therefore be calculated using Equation 2.1 as:

$$\begin{aligned} \text{ANS} &= 90^\circ - (\text{Latitude} - \text{Latitude of the Subsolar Point}) \\ &= 90^\circ - (49^\circ - 21.5^\circ) = 62.5^\circ \end{aligned}$$

When sunlight impacts the Earth's surface at an oblique angle, the insolation is stretched over a greater area, reducing its **intensity** (Figure 2.3).

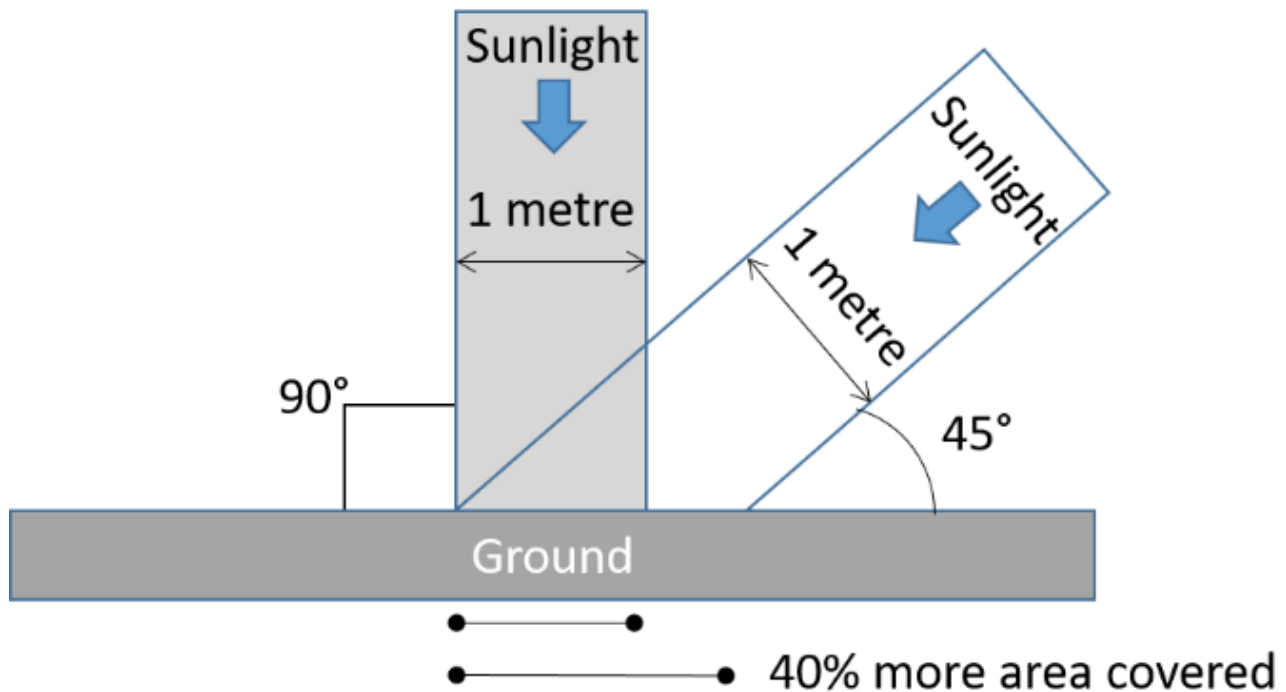


Figure 2.3. Reduction in solar intensity as sunlight encounters the Earth's surface at an oblique angle. Source: A. Perkins, CC BY-NC-SA 4.0.

We can extend the ANS calculation to also look at the effect angle of incidence has on insolation intensity using Equation 2.2:

Equation 2.2

$$\text{Intensity} = \sin(\text{ANS})$$

This is a unitless value for intensity between 0 and 1, that can be multiplied by 100 to yield a percentage of the 100% intensity currently experienced at the latitude of the subsolar point.

For example, at 49° N on July 14, and using the ANS calculated using Equation 2.1 above, the solar intensity (Equation 2.2) would be:

$$\text{Intensity} = \sin(62.5^\circ) = 0.89 \text{ or } 0.89 \times 100\% = 89\%$$

Figure 2.4 presents a summary of incoming solar radiation for July 14 at 49° N latitude. A line has been drawn on a protractor to demonstrate the incoming angle of solar radiation (ANS = 62.5°). This corresponds to a relative intensity of 0.89 or 89%.

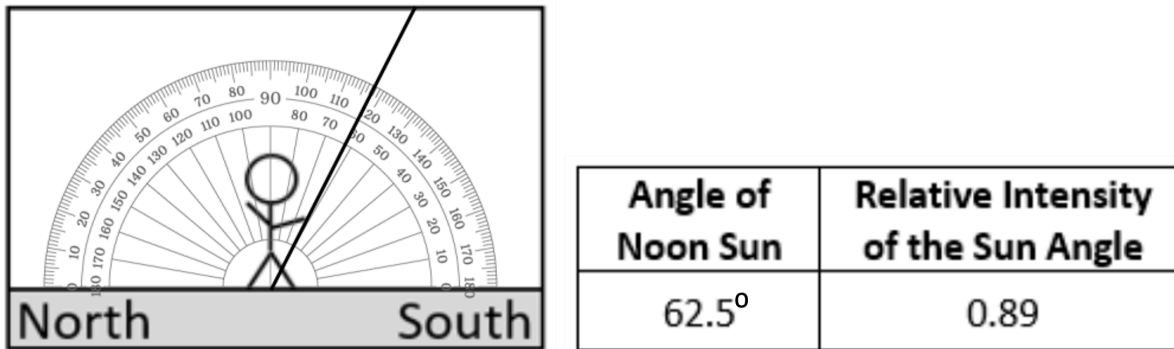


Figure 2.4. Incoming solar radiation on July 14 at 49° latitude (Eiffel Tower). The angle of the noon sun (ANS) is depicted on the protractor (left) and expressed as a value in the box (right). Relative intensity of solar radiation is also shown on the right as a unitless value (0.89). This could also be expressed as 89%. Source: A. Perkins, CC BY-NC-SA 4.0.

Earth's Energy Budget

In order to maintain a stable climate over long periods of time, the energy inputs to Earth (insolation) must be balance by energy outputs, radiated as heat. This balance is also known as Earth's energy budget. On average,

- 23% of energy is absorbed in the atmosphere by gases, dust, and other particles,
- 48% of energy is absorbed at the surface, and
- 29% of energy is reflected directly back to space by clouds, particles, or bright ground surfaces such as ice (NASA Earth Observatory (1), 2009 (<https://earthobservatory.nasa.gov/features/EnergyBalance/page4.php>)).

As we can see from these percentages, the surface of Earth and the surrounding atmosphere play different roles in energy absorption and loss. Most energy is absorbed at the surface, while most energy is radiated back to space from the atmosphere.

As noted above, approximately 48% of incoming solar radiation is absorbed at the surface. This energy is returned to the atmosphere through three processes:

1. 25% through **evaporation**, i.e., turning liquid water into water vapour,
2. 5% through **convection**, i.e., air warming in contact with the ground and rising, and
3. net 17% as infrared thermal energy (heat) (NASA Earth Observatory (2), 2009 (<https://earthobservatory.nasa.gov/features/EnergyBalance/page5.php>)).

Global Temperature Distribution and Common Temperature Scales

Based on what you now know about how the sun's energy is distributed around the globe, it should make sense that incoming solar radiation is unequally received at the Earth's surface. One of the easiest ways to see this is by examining average temperatures by latitude.

The three maps at the links below show global surface temperatures at the two solstice positions and at

the equinox. Surface temperatures are displayed as colour, with red indicating hotter temperatures and blues and purples indicating colder temperatures. You can view the complete temperature scale by clicking on the hamburger menu in the bottom-left corner of the screen. What do you notice about latitudinal changes in temperature as you move from the equator to the poles? You can click anywhere on the map to get a temperature reading for that location.

June Solstice (<https://earth.nullschool.net/#2020/06/21/0700Z/wind/isobaric/1000hPa/overlay=temp/winkel3>)

December Solstice (<https://earth.nullschool.net/#2019/12/20/0800Z/wind/isobaric/1000hPa/overlay=temp/winkel3>)

Equinox (<https://earth.nullschool.net/#2020/03/20/0700Z/wind/isobaric/1000hPa/overlay=temp/winkel3>)

Temperature is a measure of the average kinetic energy of a substance. It is a way of measuring heat energy, as heat always flows from material at a high temperature to material at a lower temperature, raising the temperature of the cooler material. There are three temperature scales that are commonly used: Celsius ($^{\circ}C$), Fahrenheit ($^{\circ}F$), and Kelvin (K). Most of the world (including most of the scientific world) uses the Celsius scale for measurement and reporting.

The following formulas allow you to convert between these scales.

Equation 2.3. Convert from Fahrenheit to Celsius:

$$T(^{\circ}C) = \frac{5}{9} \times (T(^{\circ}F) - 32)$$

Equation 2.4. Convert from Celsius to Fahrenheit:

$$T(^{\circ}F) = \left(\frac{9}{5} \times T(^{\circ}C) \right) + 32$$

Equation 2.5. Convert from Kelvin to Celsius:

$$T(^{\circ}C) = T(K) - 273$$

Equation 2.6. Convert from Celsius to Kelvin:

$$T(K) = T(^{\circ}C) + 273$$

where

- $T(^{\circ}C)$ = Temperature in degrees Celsius
- $T(^{\circ}F)$ = Temperature in degrees Fahrenheit
- $T(K)$ = Temperature in Kelvin

Temperature Gradients

A gradient is the rate of change for a value over a given distance. It can be useful for many environmental variables like imagining how topography changes over space or how temperature varies vertically or horizontally through the atmosphere.

Temperature changes along a gradient through the atmosphere are called **lapse rates**. Lapse rates can be calculated using Equation 2.7:

Equation 2.7

$$\text{Lapse rate}(\text{°C}/\text{km}) = -1 \left(\frac{\Delta T}{\Delta z} \right) = -1 \left(\frac{T_2 - T_1}{z_2 - z_1} \right)$$

where

- Δ = delta symbol, represents the **change** in the variable it precedes (for example, the change in temperature)
- T = air temperature (normally in °C)
- z = altitude (normally in km). This term can be replaced with distance if calculating a horizontal temperature gradient
- T_1, z_1 = the measurement taken at the lower point in the atmosphere

For example, let's say you wanted to know the lapse rate between the two temperature readings in the atmosphere shown on Figure 2.5.

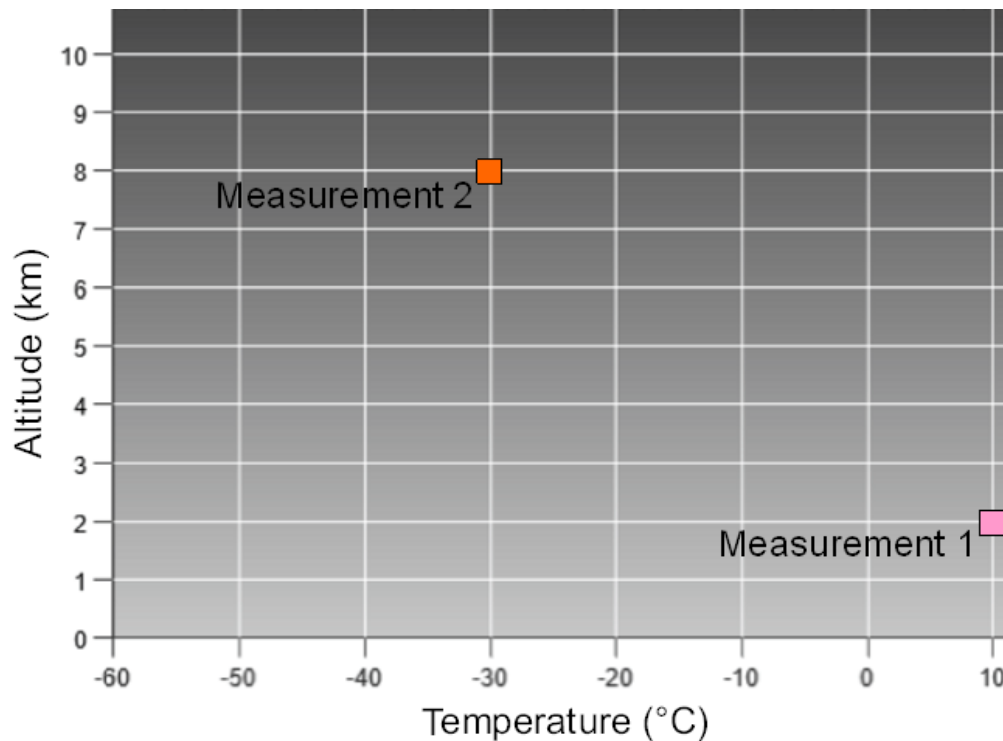


Figure 2.5. Altitude (z) and temperature (T) of two measurement locations used to calculate lapse rate. Source: A. Perkins, CC BY-NC-SA 4.0.

We can read the required values from Figure 2.5: T_1 is 10°C at z_1 of 2 km, and T_2 is -30° at z_2 of 8 km. Hence, the lapse rate is calculated using Equation 2.7 as:

$$\begin{aligned} \text{Lapse rate } (^\circ\text{C}/\text{km}) &= -1 \left(\frac{\Delta T}{\Delta z} \right) = -1 \left(\frac{T_2 - T_1}{z_2 - z_1} \right) \\ &= -1 \left(\frac{-30^\circ\text{C} - 10^\circ\text{C}}{8\text{km} - 2\text{km}} \right) = -1 \left(\frac{-40^\circ\text{C}}{6\text{km}} \right) = 6.6^\circ\text{C}/\text{km} \end{aligned}$$

Notice that the lapse rate above has a positive value. This means that based on the series in which the measurements were taken, the temperature is decreasing as the altitude increases, which is the normal condition in the troposphere.

Albedo and Aspect

Local variations in surface reflectivity, called **albedo**, and the direction a surface faces, its **aspect**, can have a major influence on that surface's absorption and retention of solar radiation.

Albedo is measured as the percentage of radiation reflected from a surface (Figure 2.6). High albedo surfaces have a high reflectivity. Surfaces like ice are highly reflective and absorb very little incoming solar radiation. Surfaces like asphalt and concrete have a very low reflectivity and absorb significant amounts of incoming solar radiation (Figure 2.6). This difference in albedo leads to significant differences in heating. In the atmosphere, clouds have a very high albedo and reflect energy, whereas particulate matter has a low albedo and absorbs energy.

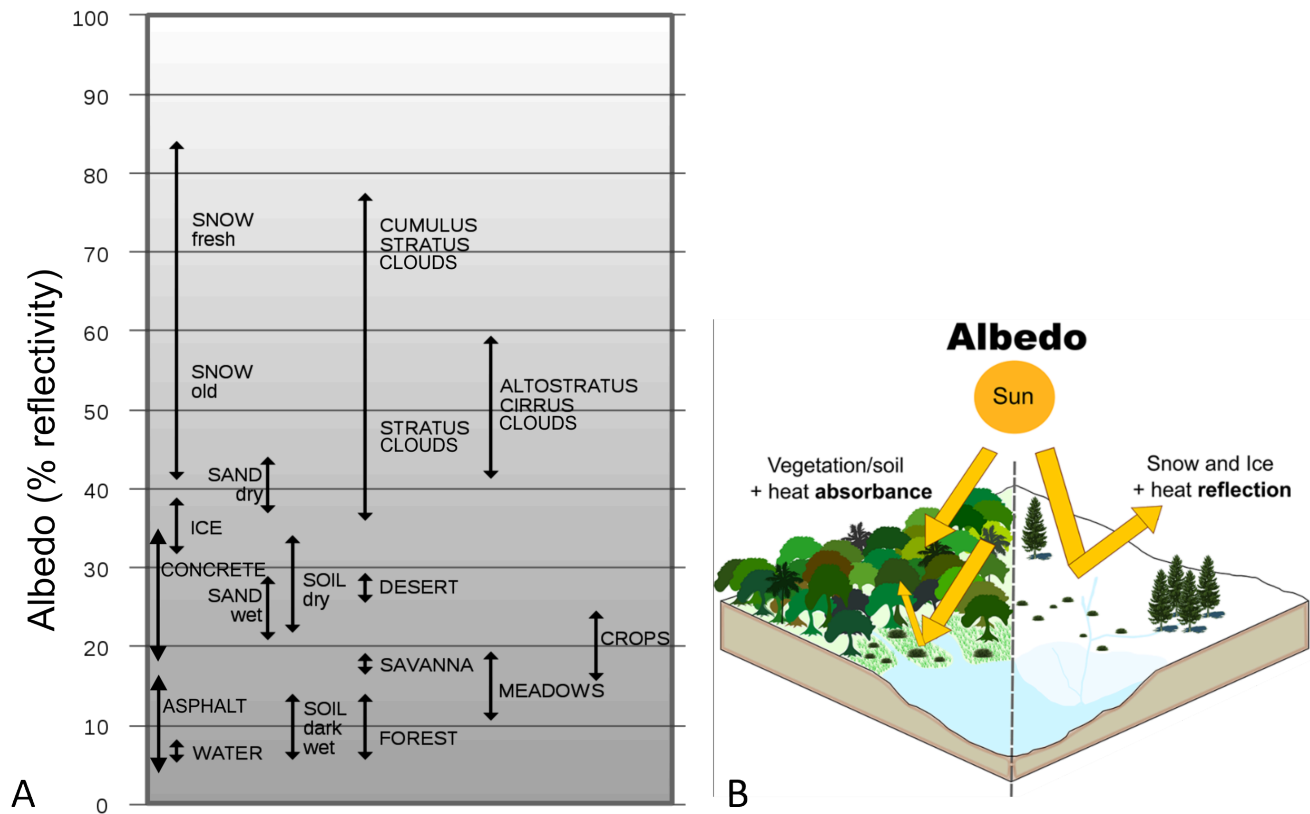


Figure 2.6. Albedo of common surfaces. Source: H. Grobe (2000) (https://commons.wikimedia.org/wiki/File:Albedo-e_hg.png)CC BY-SA 2.5. **B:** Pictorial demonstration of how albedo controls reflection and absorption of energy received from the sun. Source: Prevedello et al (2019) (<https://journals.plos.org/plosone/article?id=10.1371/journal.pone.0213368>). CC BY. [Image description]

Aspect refers to the direction a topographic slope is facing (Figure 2.7). We refer to direction based on the cardinal points of a compass. A southerly aspect means that the topographic slope is facing to the south. In the mid latitudes of the northern hemisphere, a southerly aspect means that a slope is tilted towards incoming solar radiation (based on angle of the noon sun). A northerly aspect in the same location would mean that the slope is tilted away from incoming solar radiation.

3. Set the month in the box at the bottom of the interactive to "March." Explain how the amount of solar radiation received at Earth's surface changes as you move from the equator to the north pole.
4. Now let's see how this changes throughout the year. To get the values you need, cycle through the four months in the box at the bottom of the interactive.
 - a. Record the actual amount of radiation received at Earth's surface for three latitudes: Equator, Tropic of Cancer and the North Pole in Table 2.1. This table is also provided in Worksheets at the bottom of this lab.

Table 2.1. Actual amount of radiation received at Earth's surface on the equinoxes and solstices at three locations.

Month	Equator	Tropic of Cancer	North Pole
March			
June			
September			
December			

- b. Graph the points for each month on Figure 2.8, connecting each with lines. Use different symbols for each line and include a legend to reference the symbols. This graph is also provided in Worksheets at the bottom of this lab.

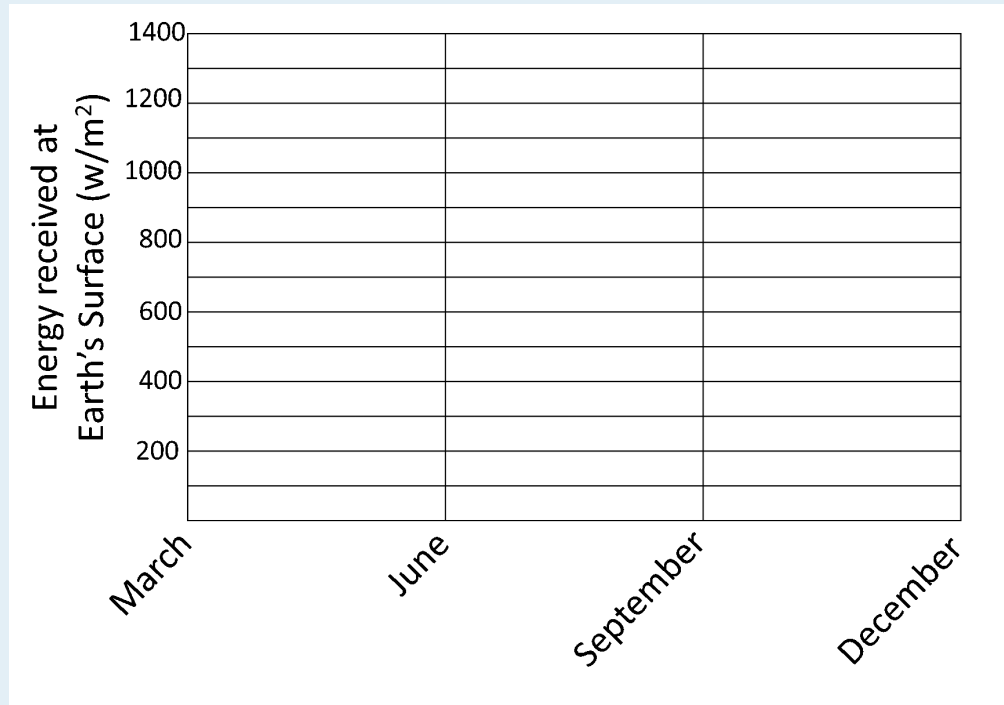


Figure 2.8. Change in energy received at Earth's surface through time. Source: A. Perkins, CC BY-NC-SA 4.0.

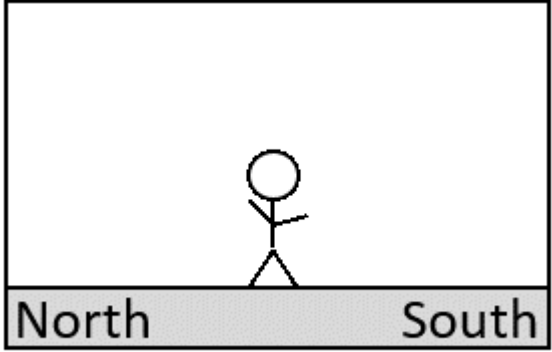
Use the analemma (Figure 2.1) to answer questions 5 and 6:

5. At what latitude is the Sun directly overhead on your birthday? Record the date and the latitude of the subsolar point.
6. Earth Day is celebrated on April 22nd every year. At what latitude is the sun directly overhead on this date?

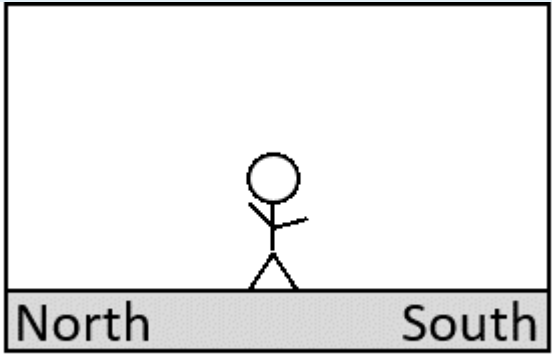
EX2: The March of the Seasons and the Angle of the Noon Sun

The latitude at which the Sun is directly overhead may be helpful in understanding overall Sun patterns, but let's say you want to set up a solar panel at your house. You need to know the sun angle for your location on a specific date so that you can setup your solar panel for optimal effectiveness.

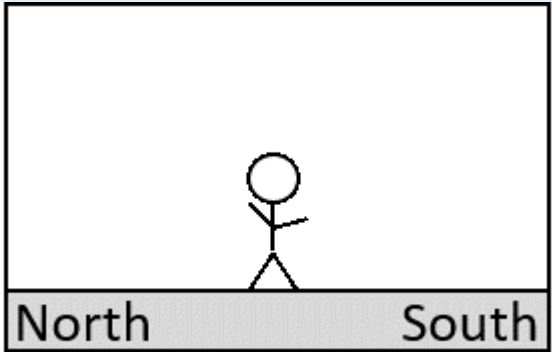
7. Complete the following calculations for angle of the noon sun (ANS) and relative solar intensity (Intensity, expressed as a percentage). Draw the angle on the figures provided. Show your working. These figures are also provided in Worksheets at the bottom of this lab.
 - a. On Oct. 3rd, if you are located at 0° latitude.

	Angle of Noon Sun	Relative Intensity of the Sun Angle

b. On April 2nd, if you are located at 61° North latitude.

	Angle of Noon Sun	Relative Intensity of the Sun Angle

c. On Dec. 9th, if you are located at 85° North latitude.

	Angle of Noon Sun	Relative Intensity of the Sun Angle

8. It's August 1st and you are climbing up the south facing slope of Mount Denali in Alaska (the highest peak in North America). At noon you come across another climber in distress and need to contact emergency services for a helicopter rescue, but your satellite phone battery is dead. Quickly you remember that you have a portable solar panel charger in your backpack. You unpack it and plug it in to the phone. It begins to charge, but very slowly. You decide to speed up the charge by setting up the solar panel at an angle.

At what angle should you set the solar panel to take the best advantage of the incoming solar radiation? **Show all relevant calculations.** Figure 2.9 is also provided in Worksheets at the bottom of this lab.

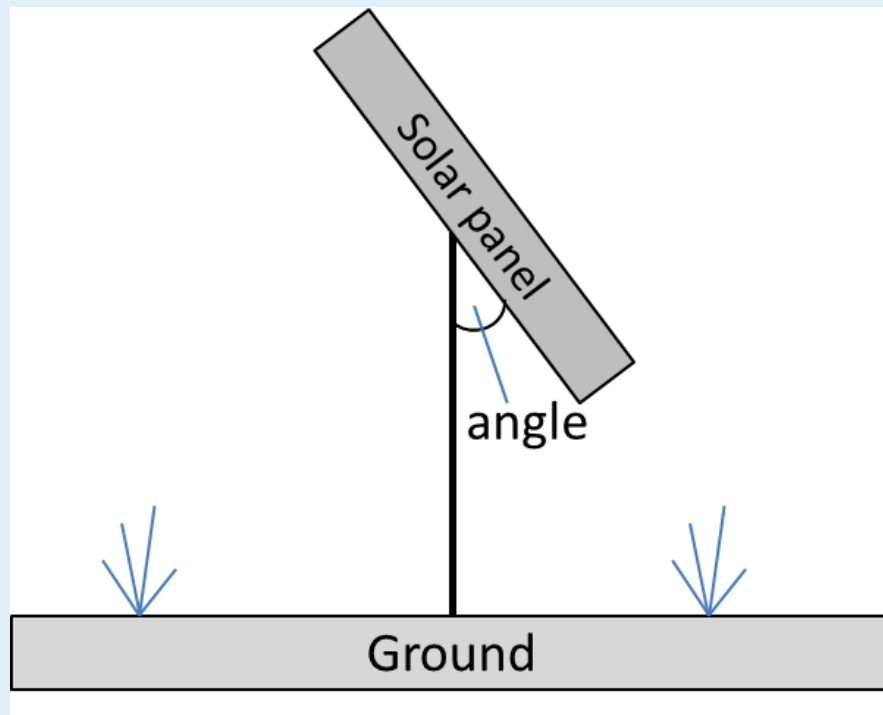


Figure 2.9. Schematic of solar panel. Source: A. Perkins, CC BY-NC-SA 4.0.

EX3: Global Temperature Distribution and Common Temperature Scales

Seasonality and Sun angle is just one way incoming solar radiation can vary for a specific location. Using satellite measurements it is possible to get a sense of how cloud cover affects incoming solar radiation.

This Satellite Temperature Data website (<https://www.ssec.wisc.edu/~tomw/ams/amsimage.html>) displays temperature data collected by a satellite looking through the atmosphere from above. It calculates the temperature from the reflective surface in the image.

9. Choose a location on the map where you can see a cloudless area near the coast. Compare the land and ocean temperatures at this latitude. Is there a difference between the temperatures? Explain why this is the case.
10. Now compare the temperatures in the previous question with the temperature measurement at the top of a nearby cloud.
 - a. Is the temperature at the top of the cloud higher or lower than the land and water surfaces?
 - b. What does this tell you about how energy radiated from the Earth's surface is affected

as it interacts with clouds in the atmosphere on its way out to space?

- c. Assume the top of the cloud is at the top of the troposphere, 18 km above the land surface for your location. Calculate the lapse rate between the Earth's land surface and the top of the cloud. Show your work.

On April 10, 1912 the steamship Titanic left Southampton England on its maiden voyage across the Atlantic Ocean to New York (Figure 2.10). By the evening of April 15, the Titanic was sinking in the middle of the Atlantic Ocean, after striking an iceberg. The Titanic sank in the cold waters of the northern Atlantic.



Figure 2.10. Titanic on its maiden voyage, off the coast of Ireland (Photo taken on April 11, 1912). Source: Cobh Heritage Centre, Public Domain (<https://commons.wikimedia.org/wiki/File:Titanic-Cobh-Harbour-1912.JPG>).

11. The surface temperature when the Titanic left Southampton, England was 53.1 °F. Convert this temperature to °C.
12. The average daily maximum temperature for Southampton, England in April 1912 was 288.5 K. Was the temperature when the Titanic left higher or lower than this average?
13. The city of Calgary, Alberta is located at a similar latitude to the city of Southampton, England. In April 1912, the average daily maximum temperature in Calgary was 5.5 °C. Explain the physical geography surrounding why this temperature is so different than the average daily maximum temperature in Southampton. Hint: you may need to look at a map of where Calgary is located relative to where Southampton is.

The Titanic sailed in April, between the extreme conditions of summer and winter. Consult the global temperature maps below for an example of January and July temperatures:

- July Temperatures (<https://earth.nullschool.net/#2019/07/15/0700Z/wind/isobaric/1000hPa/overlay=temp/winkel3>)
- January Temperatures (<https://earth.nullschool.net/#2020/01/01/0800Z/wind/isobaric/1000hPa/overlay=temp/winkel3>)

Recall that the maps show temperature displayed as colour: reds indicate hotter temperatures and blues to

purples indicate colder temperatures. So, all locations with the same colour will have similar temperatures. You can click anywhere on the map to get a temperature reading for that location.

14. Is the temperature contrast between the equator and the Arctic region greatest in winter or summer for the northern hemisphere?
15. If latitude were the only control on temperature, the colour bands indicating similar temperatures should run straight across the map from east to west.
 - a. Identify one area on the map where this occurs. Use your knowledge of place names or use an atlas or Google Earth (<https://www.google.com/earth/index.html>) to determine the name of the location you identified.
 - b. What physical geography conditions explain why the temperatures follow this pattern in the place you identified?
16. Compare the January and July maps temperature maps.
 - a. Describe one area of the world that exhibits a large annual temperature range.
 - b. What physical geography conditions explain the large annual temperature range for the place you identified?
17. The atmospheric conditions on the night of April 15, 1912 were clear, that is, there was no cloud cover. How do you think the lack of clouds that night affected the air temperature, according to what we know about local energy budget and how clouds interact with radiation?
18. The last emergency communication from the Titanic before it sank gave its position at the following coordinates: 41° 46' N, 50° 14' W. Go back to the Satellite Temperature Data website (<https://www.ssec.wisc.edu/~tomw/ams/amsimage.html>). Find some open water in the Atlantic Ocean at a latitude of around 41°N.
 - a. Record the surface water temperature in °C.
 - b. Survival rates for humans in specific water temperatures are given in Table 2.2. Based on the water temperature you obtained in part a, how long would an individual have been able to survive in open water after abandoning the Titanic?

Table 2.2. Expected time of survival for humans in specific water temperatures.

Water Temperature (°F)	Expected Time of Survival
32.5°	45 minutes
32.5–40°	30 – 90 minutes
40–50°	1 – 3 hours
50–60°	1 – 6 hours
60–70°	2 – 40 hours
70–80°	3 hours – indefinite
> 80°	Indefinite

EX4: Lapse Rates

Several distress rockets were fired into the air to alert nearby ships of the Titanic's position and to aid in the rescue effort. Standard temperature values for different layers of the atmosphere are presented in Table 2.3.

Table 2.3. Standard atmospheric temperature at specific points in the atmosphere.

Atmospheric layer	Altitude (km)	Temperature (°C)
Surface (Northern hemisphere)	Sea level (0)	15
Tropopause	18	-57
Stratopause	50	0
Mesopause	80	-90
Thermopause	480	1200

- Plot the standard atmospheric temperature values presented in Table 2.3 on the Exercise 4: Temperature Gradients Graph (provided in the Worksheets). Connect the points with a line and label the troposphere, stratosphere, mesosphere and thermosphere.
- The distress rockets passed through the lowest part of the atmosphere. Calculate the lapse rate in the lowest 10 km of the troposphere from the graph you created.

EX5: Albedo and Aspect

Take a look at the glaciers that cover Mount Rainier, a stratovolcano in Washington, USA in Figure 2.11, and use it to answer the questions that follow.

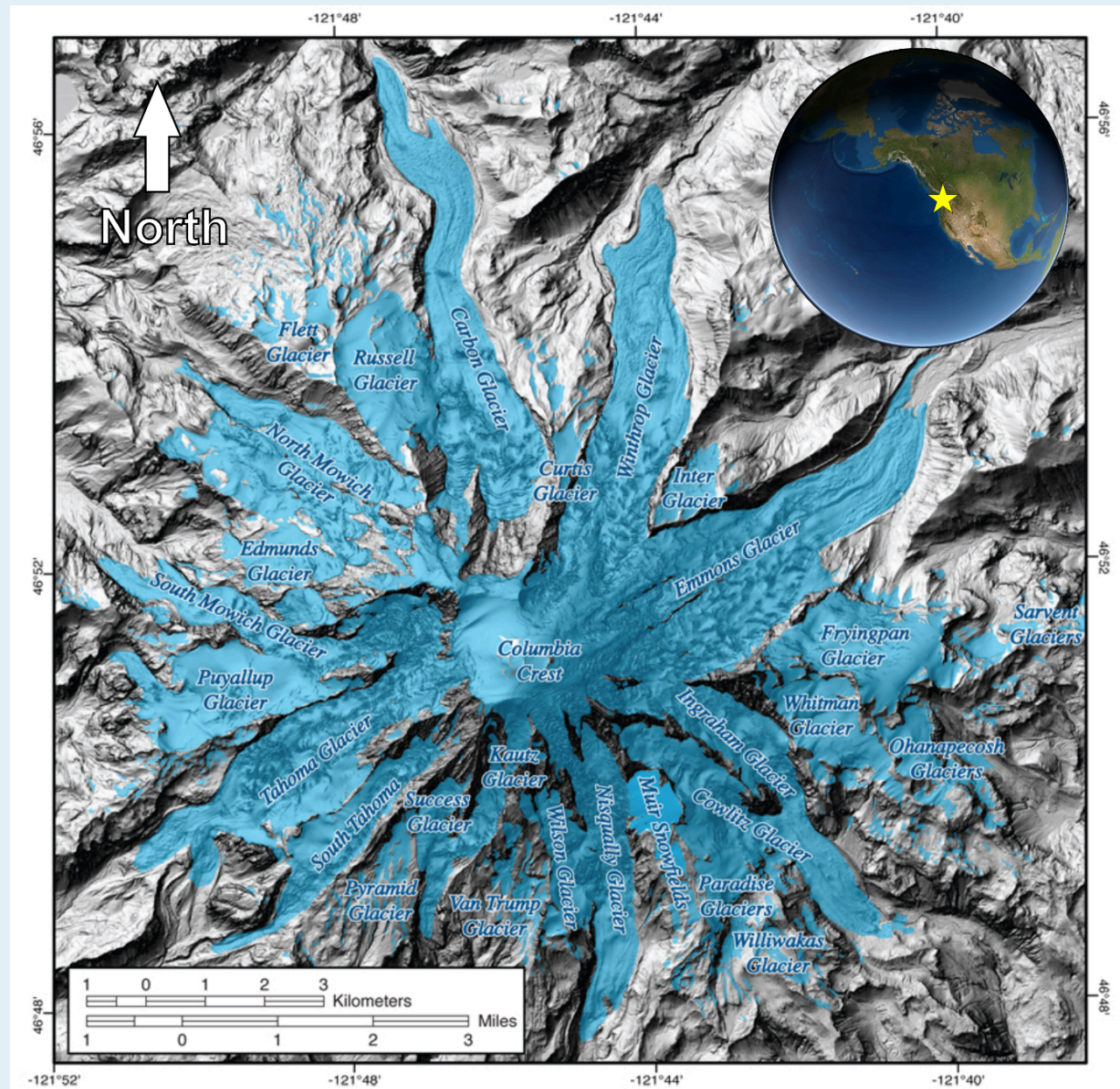


Figure 2.11. Mount Rainier, WA glacier coverage. The yellow star in the map inset shows where Mount Rainier is located in North America. Source: Tom Sisson, USGS, Public Domain (<https://www.usgs.gov/media/images/glaciers-mount-rainier-overlaid-a-base-map-lidar-image-which>).

21. Mount Rainier contains the greatest amount of glacier ice of any mountain in the lower 48 United States.

- a. Do you think aspect has a role in controlling the distribution and size of glaciers around the central peak of Mount Rainier? Explain your answer.
 - b. Choose three different glaciers from different locations around the main peak. Compare their aspect and relative size.
22. The zones in between the glaciers are covered mostly in bare rock and light forested vegetation.
- a. How do you think the albedo differences between the middle of the glacier and the locations between the glaciers affects how the glacier melts?
 - b. As the glacier melts further back, more sediment and bare rock is revealed. Do you think this negatively or positively reinforces the melt rate of the glacier? Explain your answer.

Reflection Questions

1. Imagine if Earth was not tilted 23.5° on its axis, but instead had no tilt. How would this affect Earth's energy budget?
2. If the Titanic had sunk on a cloudy night, how would that have affected air temperature conditions and potential survivability for those who had to abandon the ship as it sunk?
3. The southern hemisphere is about 81% water at the surface, whereas the northern hemisphere is about 61% water how do you think this difference affects the local energy budget for these two different hemispheres?

Worksheets

Lab 02 Student Workbook [Word] (<https://pressbooks.bccampus.ca/geoglabmanualv2/wp-content/uploads/sites/1340/2021/08/Lab-2-Student-Workbook.docx>)

Lab 02 Student Workbook [ODT] (<https://pressbooks.bccampus.ca/geoglabmanualv2/wp-content/uploads/sites/1340/2021/08/Lab-2-Student-Workbook.odt>)

Lab 02 Student Workbook [PDF] (<https://pressbooks.bccampus.ca/geoglabmanualv2/wp-content/uploads/sites/1340/2021/08/Lab-2-Student-Workbook.pdf>)

References

Prevedello, J.A., Winck, G.R., Weber, M.M., Nichols, E., & Sinervo, B. (2019) Impacts of forestation

and deforestation on local temperature across the globe. *PLoS ONE*, 14(3). <https://doi.org/10.1371/journal.pone.0213368>

Olson, M. & Rupper, S. (2019) Impacts of topographic shading on direct solar radiation for valley glaciers in complex topography, *The Cryosphere*, 13, 29–40. <https://doi.org/10.5194/tc-13-29-2019>.

Image Descriptions

Figure 2.1. Analemma diagram

The diagram shows an Analemma, a graph that demonstrates the latitude where the sun is directly overhead for different days of the year. For example, on the equinox dates it is directly overhead at the equator. The shape of the graph is in a figure-eight. The dates are shown on the figure-eight portion of the diagram and the latitudes are written on the y-axis.

[Return to Figure 2.1]

Figure 2.6. Albedo of common surfaces.

In part A) of the figure there is a table that shows different materials and their associated albedo measured as percent reflectivity. Water is at the bottom of the scale, with a low albedo and percentage of reflectivity and snow and ice are on the high end of the scale with a high albedo and percentage reflectivity. In part B) there is an image of two different land surfaces, the left side showing a highly vegetated surface that absorbs significant solar energy with low reflection, and the right side showing a bare land surface with significant reflection and high albedo.

[Return to Figure 2.6]

Lab 03: Atmospheric Structure and Pressure Systems

Leonard Tang

This lab is designed for you to gain an understanding of the basic structure of our atmosphere using real data. In addition, you will also learn the different types of pressure systems, how to identify them, and their relationships with atmospheric circulation, the phenomena you may be more familiar with calling by the name of wind.

Learning Objectives

After completion of this lab, students will be able to

- Identify the different temperature layers in the lower atmosphere.
- Produce a sounding (temperature profile) using an Excel spreadsheet.
- Understand and calculate the Environmental Lapse Rate.
- Identify high- and low-pressure systems.
- Relate pressure systems and wind.

Pre-Readings

In order to complete this lab, you will need some background on the structure of the atmosphere, pressure systems and circulation, and calculating lapse rates.

Atmospheric Structure

Although it may not be visible to us from Earth, the atmosphere surrounding Earth has a number of layers that have different characteristics and perform different functions in supporting life on Earth. Key features of the lower atmosphere are the **troposphere**, the **tropopause**, and the **stratosphere**.

Quick reviews of atmospheric structure are provided in

- Atmospheric Structure Part 1 (https://www.thephysicalenvironment.com/Book/atmosphere/atmospheric_structure.html): the troposphere and tropopause; and
- Atmospheric Structure Part 2 (https://www.thephysicalenvironment.com/Book/atmosphere/atmospheric_structure_p2.html): the stratosphere and beyond, and the functional layers of the atmosphere.

Pressure Systems and Circulation

Atmospheric pressure is the weight of air exerted on a surface. **Wind** is a direct result of the difference in atmospheric pressure between two places, that is, the pressure gradient between two locations. This means that if we know the spatial distribution of pressure systems over a certain area, we can determine the wind patterns in that same area.

For example, the EarthWindMap website (<https://earth.nullschool.net/>) provides a visualization of wind patterns. Open the website to see the wind represented by the animated white lines. These wind patterns can help us identify where the major **high-** and **low-pressure systems** are located. Recall that winds blow outward from high-pressure systems in a clockwise direction, whereas winds blow inward to low pressure systems in a counterclockwise direction. Can you use the animation to help you identify high- and low-pressure systems? Figure 3.1 provides a static example.

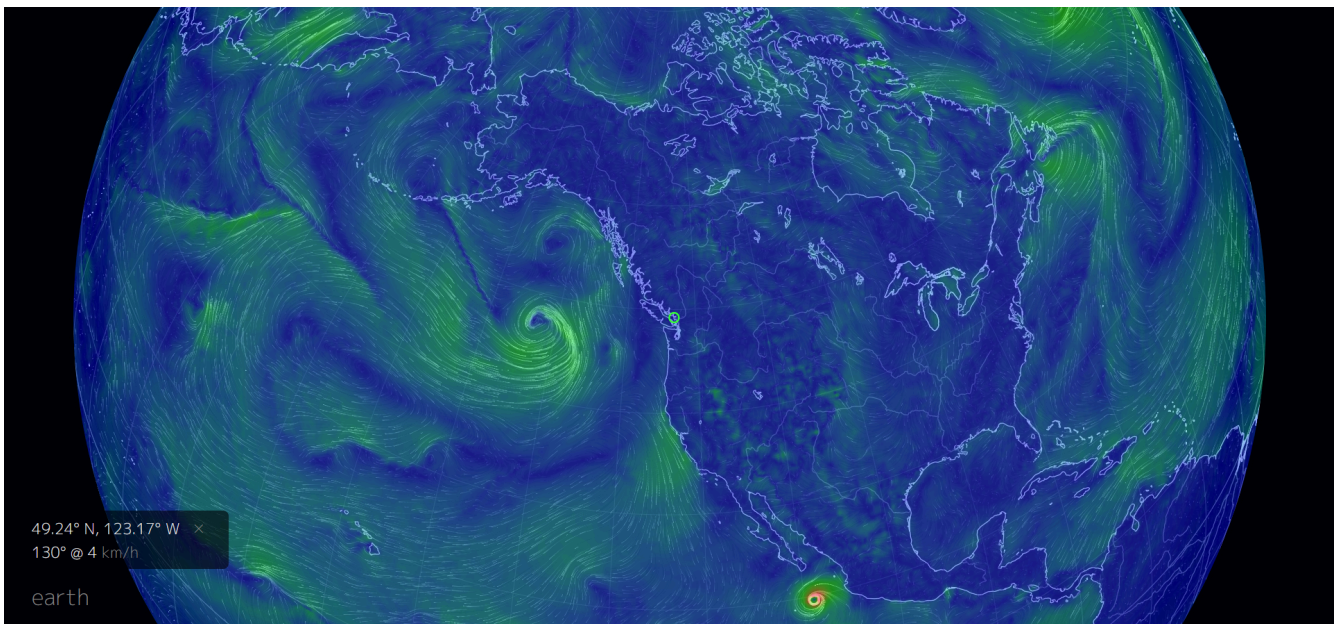


Figure 3.1. Wind patterns in North America. Source: L. Tang, generated using EarthWindMap (<https://earth.nullschool.net/>) by C. Beccario. CC BY-NC-SA 4.0.

Another common method to look at pressure systems is to look at an actual weather map. Figure 3.2 is a surface weather map produced by Environment Canada. Notice the isobars drawn on the map, as well as the **high-pressure (H)** and **low-pressure (L)** systems. Recall that isobars are lines of equal pressure.

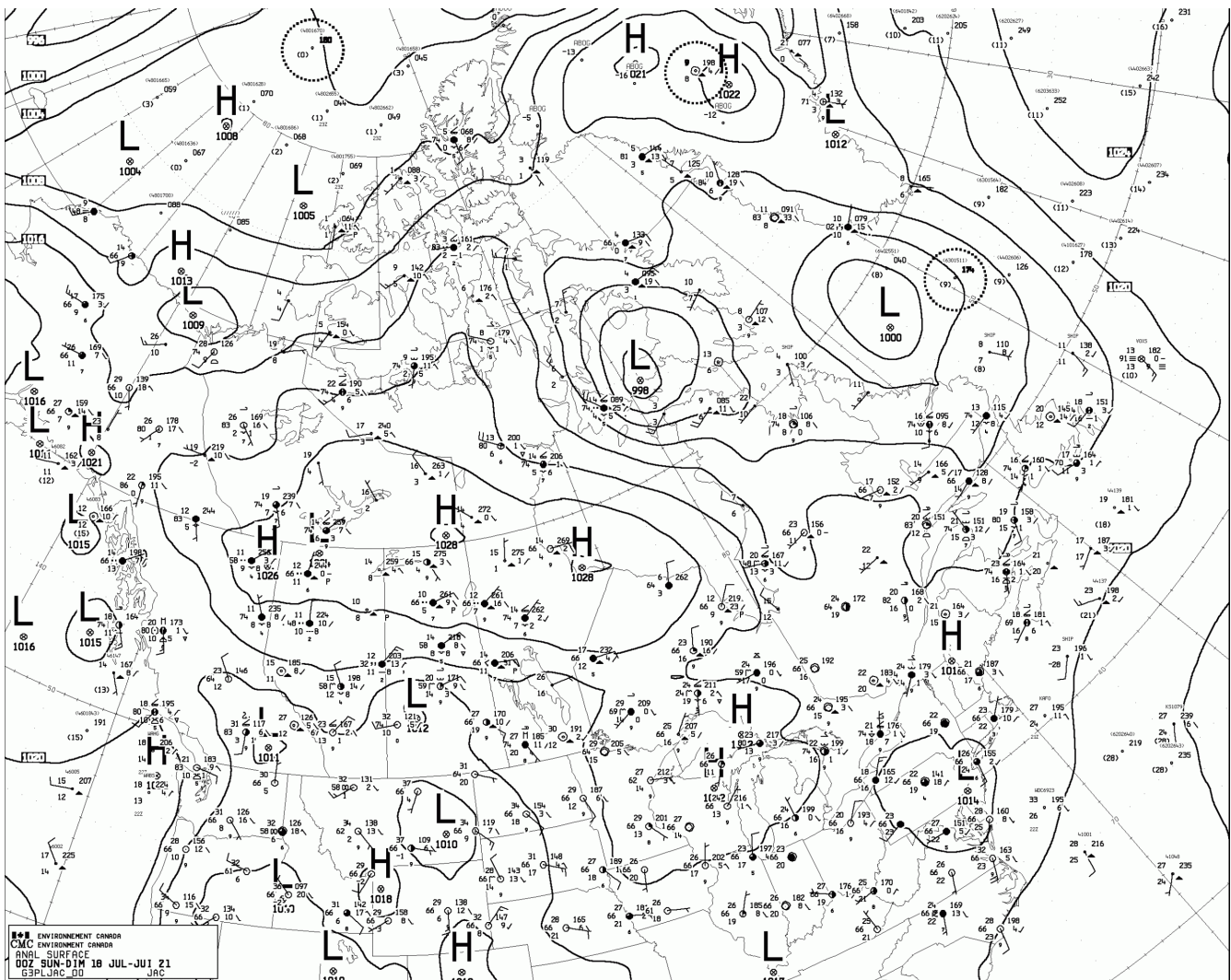


Figure 3.2. Preliminary surface analysis map for Saturday 17 July, 2021 at 5pm (converted from the given Zulu time). H indicates the location of a high-pressure system; L indicates the location of a low-pressure system. The solid lines are isobars, lines of equal pressure. Source: Environment and Climate Change Canada. Permission for non-commercial use (<https://www.canada.ca/en/transparency/terms.html>).

For a more detailed explanation, please review Atmospheric Circulation (https://www.thephysicalenvironment.com/Book/circulation/title_page.html). Please note that when you visit this website a video (drought_88_winds_reduced (MOV)) may download. This is the animation referred to in the first paragraph on the page. To watch it, open the file in your default video player.

EarthWindMap Website

One of the exercises in this lab requires you to use the EarthWindMap website (<https://earth.nullschool.net/>). This website allows you to visualize earth conditions by animating the wind, currents, or waves with a range of overlays, including wind, temperature, and relative humidity at a range of heights, with data provided by a number of sources. In this lab we will use the wind animation with the temperature overlay.

In the **earth** menu, the height of the atmosphere is provided in hectopascals (hPa). For reference, pascal (Pa) is the SI unit of measurement for pressure. One hectopascal is equivalent to 100 pascals or 0.1 kilopascals (kPa). The average sea-level pressure is 1013.25 hPa. The approximate heights (in kilometres, km) that correspond to the different pressures are presented in Table 3.1.

Table 3.1. Conversion table for pressure (hPa) and approximate height above sea level (km).

Pressure (hPa)	Approximate Height (km above sea level)
1000	0
850	1.5
700	3.0
500	5.5
250	10.0
70	18.5
10	31.0

This website presents wind direction as an **azimuth**. Azimuth refers to the compass direction expressed in degrees as a number between 0 and 360. Directions expressed as an azimuth do not include cardinal directions (north, south, east, west and their derivatives). For example, northwest has an azimuth of 305° .

Calculating Environmental Lapse Rates

The lapse rate is the rate of change of temperature with altitude in the atmosphere. The lapse rate of the troposphere is technically called the Environmental Lapse Rate (ELR). To calculate the ELR, we need to know the temperature at the surface, assumed to be equal to 1000 hPa (T_1) and the temperature at the tropopause (T_2), and the altitude of the surface at mean sea level (z_1) and the altitude of the tropopause (z_2).

With this information, the ELR can be calculated using Equation 3.1:

Equation 3.1

$$\text{ELR} (^{\circ}\text{C}/\text{km}) = -1 \left(\frac{\Delta T}{\Delta z} \right) = -1 \left(\frac{T_2 - T_1}{z_2 - z_1} \right)$$

where

- Δ = delta symbol, represents the **change** in the variable it precedes (for example, the change in temperature)

- T = air temperature (normally in $^{\circ}\text{C}$)
- z = altitude (normally in km)
- T_1, z_1 = the measurement taken at the lower point in the atmosphere

Let us assume that the temperature at 1000 hPa is 19.7°C and the temperature at the tropopause is -56.3°C . For simplicity, assume the tropopause is at 12 km above sea level. In actuality, the height of the tropopause varies with latitude and time of year. The ELR is calculated using Equation 3.1 as

$$\text{ELR}(^{\circ}\text{C}/\text{km}) = -1 \left(\frac{T_2 - T_1}{z_2 - z_1} \right) = -1 \left(\frac{-56.3^{\circ}\text{C} - 19.7^{\circ}\text{C}}{12 \text{ km} - 0 \text{ km}} \right) = 6.33^{\circ}\text{C}/\text{km}$$

The ELR is $6.33^{\circ}\text{C}/\text{km}$, meaning the temperature drops by about 6°C for each kilometre we go up in the troposphere.

Lab Exercises

In this lab you will:

- Construct a sounding of the lower atmosphere and identify the layers present in the lower atmosphere.
- Calculate the Environmental Lapse Rate of the troposphere.
- Identify pressure systems and wind direction on weather maps.

You will need a web browser (Chrome or Firefox preferable), Excel, and a calculator to complete the lab assignment.

EX1: Construct a Sounding (Temperature Profile) of the Lower Atmosphere

In this exercise, you will obtain temperature data and plot them on a graph to produce a sounding.

Step 1: Go to Vancouver on EarthWindMap (<https://earth.nullschool.net/#current/wind/surface/level/overlay=temp/orthographic=-123.81,49.18,3000/loc=-123.166,49.236>). The green circle on the map is the approximate location of Vancouver (Figure 3.3). At the bottom left of the map, you will see the coordinates of Vancouver (49.24°N 123.17°W), the wind direction (145° , expressed as azimuth), wind speed (5km/h), and air temperature (16.6°C) at the surface.

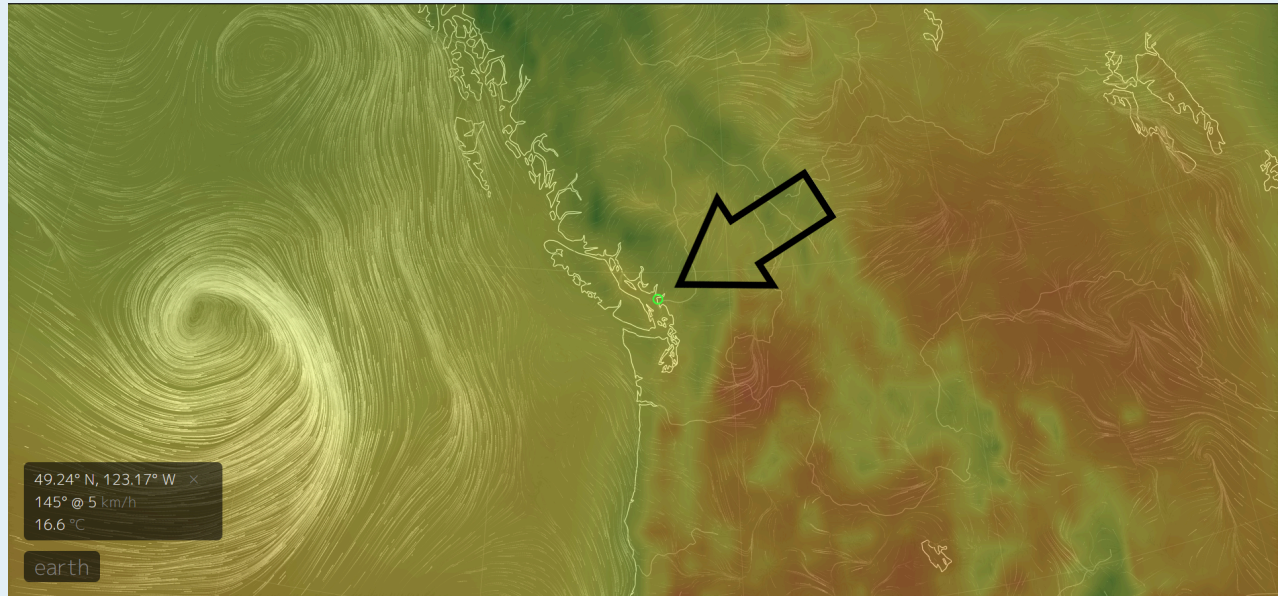


Figure 3.3. Atmospheric conditions in SW British Columbia, Canada. The green circle in the centre (at the tip of the arrow) shows the approximate location of Vancouver. Wind direction is shown by white lines. These lines are animated on the website. Source: L. Tang, generated using EarthWindMap (<https://earth.nullschool.net/>) by C. Beccario. CC BY-NC-SA 4.0.

Step 2: Click on **earth** at the bottom-left of the screen and the menu will expand. In this exercise we will use the temperature data at different heights. For example, in Figure 3.4 the temperature in Vancouver at the surface is 16.6°C, on August 18th, 2020 at 20:00 local time.

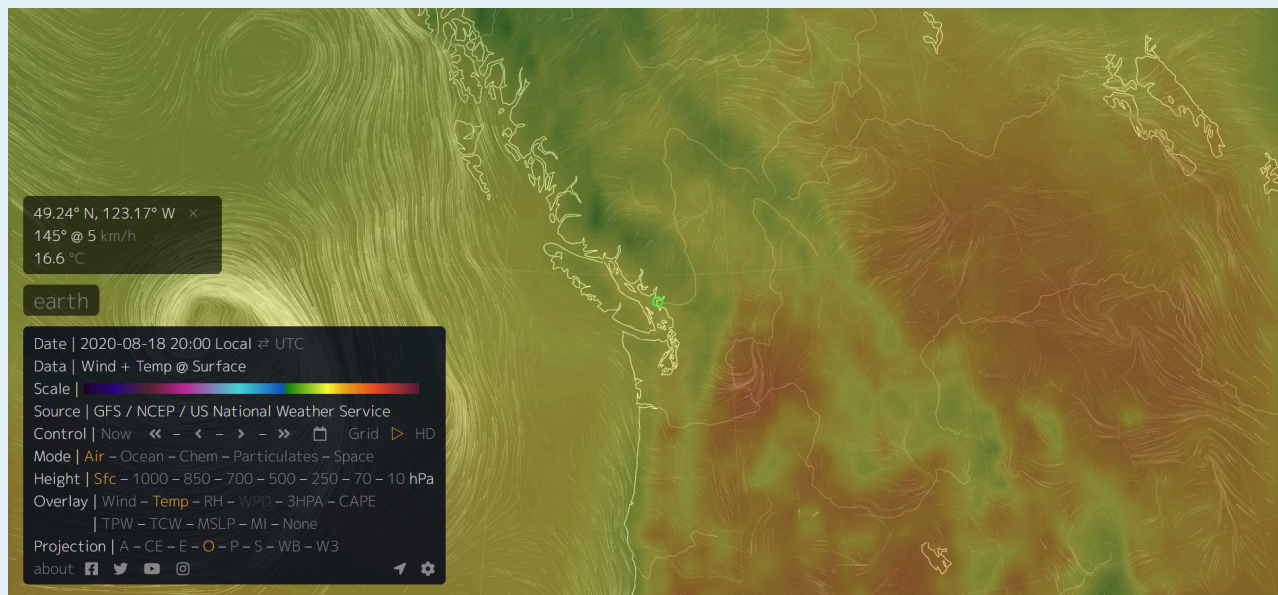


Figure 3.4. Atmospheric conditions in SW British Columbia, Canada with menu open. Temperature is indicated by colour ranging from hot (red) to cool (dark green). The complete scale is provided in the menu box. Source: L. Tang, generated using EarthWindMap (<https://earth.nullschool.net/>) by C. Beccario. CC BY-NC-SA 4.0.

Step 3: Open an Excel spreadsheet and set up a table similar to Table 3.2. Starting at 1000 hPa, obtain temperature data at each available elevation by clicking on the heights one by one in the **Height** option in the menu. The temperature (and other data) will change in the values box located above the menu box on your

screen. Record the values in your table. Also record the date and time from the Earth Wind map at which you obtain your values.

Table 3.2. Example table of pressure and temperature data obtained from *EarthWindMap*.
(<https://earth.nullschool.net/>) *Source: L. Tang, CC BY-NC-SA 4.0.*

Pressure (hPa)	T (°C)
1000	19.7
850	12.7
700	4.2
500	-12.1
250	-48.3
70	-56.3
10	-38.6

Step 4: Plot the data. **Reverse the columns so that temperature is the left column and pressure is the right column.** Then select all the data including the column headings. Click **Insert** to open the Insert tab. Click a **Scatter chart with smooth lines and markers**. A chart will appear on your spreadsheet. Hopefully, it will show a line with pressure values on the vertical axis and temperature values on the horizontal axis.

We need to make two modifications to make our data easier to understand:

1. We want the pressure values to be the highest at the bottom, to correspond to the high pressures at the bottom of the atmosphere. To do this, double click on the numbers in the vertical axis and a **Format Axis** box will appear to the right of your screen. Click **Axis Options** at the top and open the detailed **Axis Options** options by clicking on the triangle to the left of the title. Scroll down and click on the check box for **Values in reverse order**. To move the axis to the bottom of the graph, scroll up to **Horizontal axis crosses** and select **Maximum axis value**.
2. We don't want the vertical axis to interrupt our view of our data. Double click on the numbers in the horizontal axis and a revised menu will appear in the **Format Axis** box. Scroll down to **Vertical axis crosses**, select **Axis value** and type the value in the box to the right that is a little lower than your lowest temperature reading.

Step 5: Complete your graph by adding a title and labeling the axes. Include the location, date and time in your title, and units in the axis labels. The resulting graph shows the vertical temperature variation of the lower atmosphere, also known as a sounding. An example is shown on Figure 3.5.

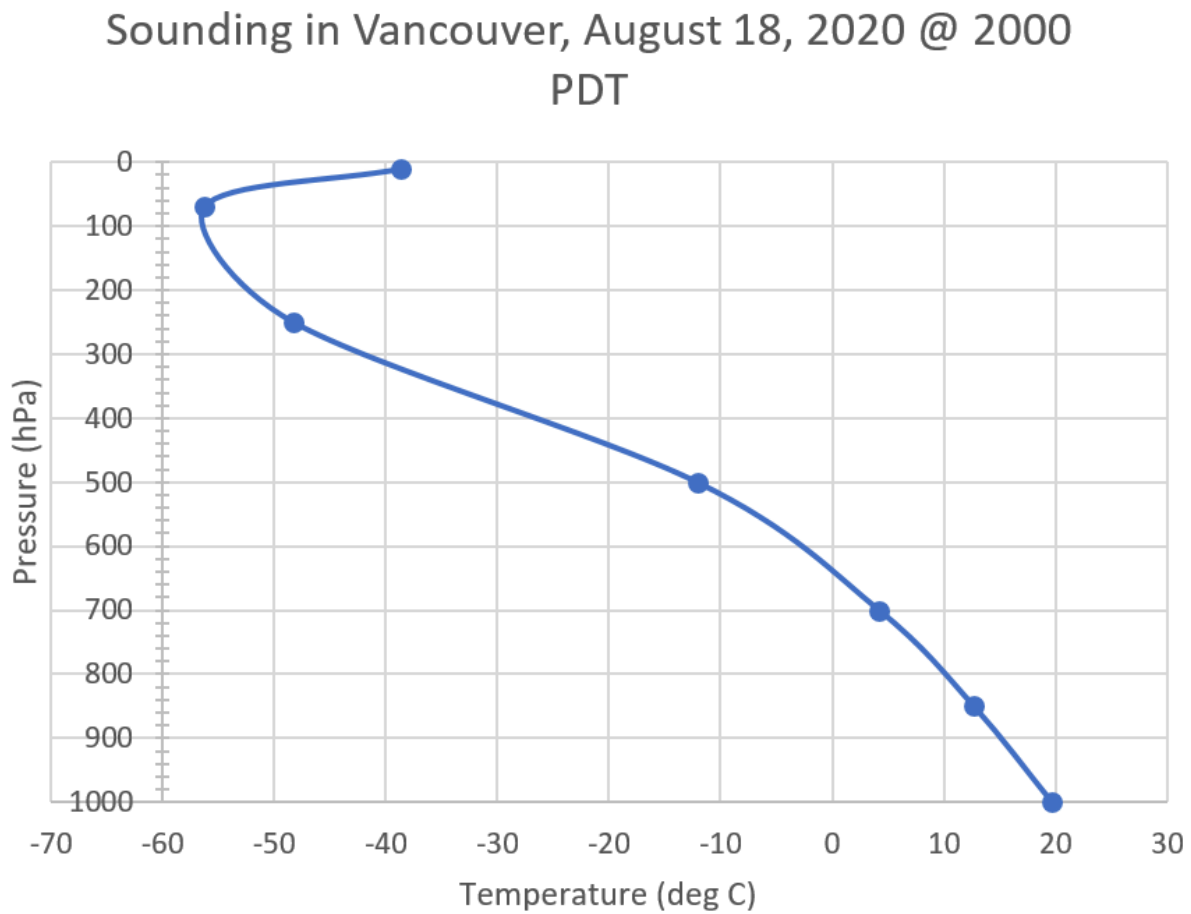


Figure 3.5. Atmospheric sounding in Vancouver, August 18, 2020 at 2000 PDT. Source: L. Tang. CC BY-NC-SA 4.0.

EX2: Identifying Temperature Layers of the Atmosphere

On the sounding you plotted in EX1, label these three important locations:

- troposphere
- tropopause
- stratosphere

Use textboxes to put labels on your graph. Use arrows to show the extent of the troposphere and stratosphere.

EX3: Calculating the Environmental Lapse Rate

Using the data collected, calculate the lapse rate of the troposphere, also called the Environmental Lapse Rate. Obtain the required temperatures from the graph you created in EX1 and EX2. Convert the altitude in pressure (hPa) to km using Table 3.1.

Show your calculation and answer in a text box next to the sounding. Enter your working as an equation using the **Equation** editor. Note that the **Equation** editor will only become available **after** you insert a text box.

The concept and the importance of lapse rate is examined in Lab 08 under the topic of Atmospheric Stability.

EX4: Pressure Systems and Their Relationships With Wind

1. Your instructor will provide you with a map similar to Figure 3.1. Annotate the map by adding **H** and **L** where the main pressure systems are located.
2. Obtain the Surface Analysis Map from Worksheets. Draw arrows on the map to indicate the wind directions based on where the high- and low-pressure systems are located. Draw 3-4 arrows for each pressure system on the map.

Reflection Questions

1. Using the data you collected in EX1, briefly explain why temperature varies in the troposphere. For example, if you climb a mountain 3 km tall at the location you chose, how and why would the temperature change?
2. If the temperature variation in the troposphere is reversed (i.e. temperature increases with elevation) what phenomenon is it?
3. In your own words, explain how pressure systems and wind are related. How and why are the spacing of isobars on a weather map important?

Worksheets

Surface Analysis Map. Note that this is a **live** link. The map updates on a regular basis.

- Surface Analysis Map [GIF] (https://weather.gc.ca/data/analysis/jac12_100.gif)

Lab 04: Weather Forecasting

Terence Day

Weather forecasts... do you trust them? If not, then can you do better? In this lab you will prepare your own weather forecast for tomorrow. You can do the forecast for anywhere in Canada that you're located. If you're not presently in Canada, then you can do it for a Canadian place of your choosing.

Learning Objectives

After completion of this lab, you will be able to

- Use a climate forecast to determine **normal** weather for a particular place.
- Describe current weather conditions.
- Convert UTC to local time.
- Interpret cloud cover from satellite imagery.
- Read a weather map.
- Construct a weather forecast.

Pre-Readings

Weather Radar

Weather radar is an application of Doppler radar. In this technique, a ground based antenna sends a pulsed radio-frequency beam out into the atmosphere, and then listens for the response. The responses are echoes created by radio waves hitting particles of precipitation (rain, snow, ice) and rebounding. The intensity of the echo (energy) is a function of the number, size and type of precipitation particles (Environment and Climate Change Canada, 2021). Be aware that gaps may appear in the data because the radio waves can be blocked by hills and mountains. Some radars are blocked from looking in these directions, and so a permanent blanked sector will be visible.

Coordinated Universal Time (UTC), also known as UTC, or Zulu time, is used to state the time of data collection. Note that the concept of UTC is different from GMT (<https://www.timeanddate.com/time/gmt-utc-time.html>) (Greenwich Mean Time), but the times are actually the same.

Satellite Imagery and Clouds

Satellite imagery is a type of remote sensing. Satellite imagery is created from radiant energy emitted by surface features of Earth that is sensed by satellites. This data is sent to receiving stations on the ground where it is broken down into pixels and identified by coordinates. Weather satellites have geostationary orbits, which means that they are effectively parked above the same location on Earth at all times.

Different types of clouds can be identified on satellite images. Cloud type can be identified by shape and height. Remember that it gets colder as you get higher. If a cloud is very low (where the temperature is similar to ground temperature) and featureless it is probably **stratus**. If it's fairly low and lumpy in texture it's probably **cumulus**, and if it's high and streaky it is **cirrus**. **Cumulonimbus** can be identified by the range of different temperatures within the cloud, and sometimes the anvil shape of those clouds is apparent.

Reading Weather Maps

Weather maps contain a lot of information, and reading them takes some practice. An example complete surface weather map (northern hemispheric coverage) produced by Environment and Climate Change Canada is provided as Figure 4.1. Take a moment to inspect the map, and pick out the features that are familiar to you, as well as those that are not.

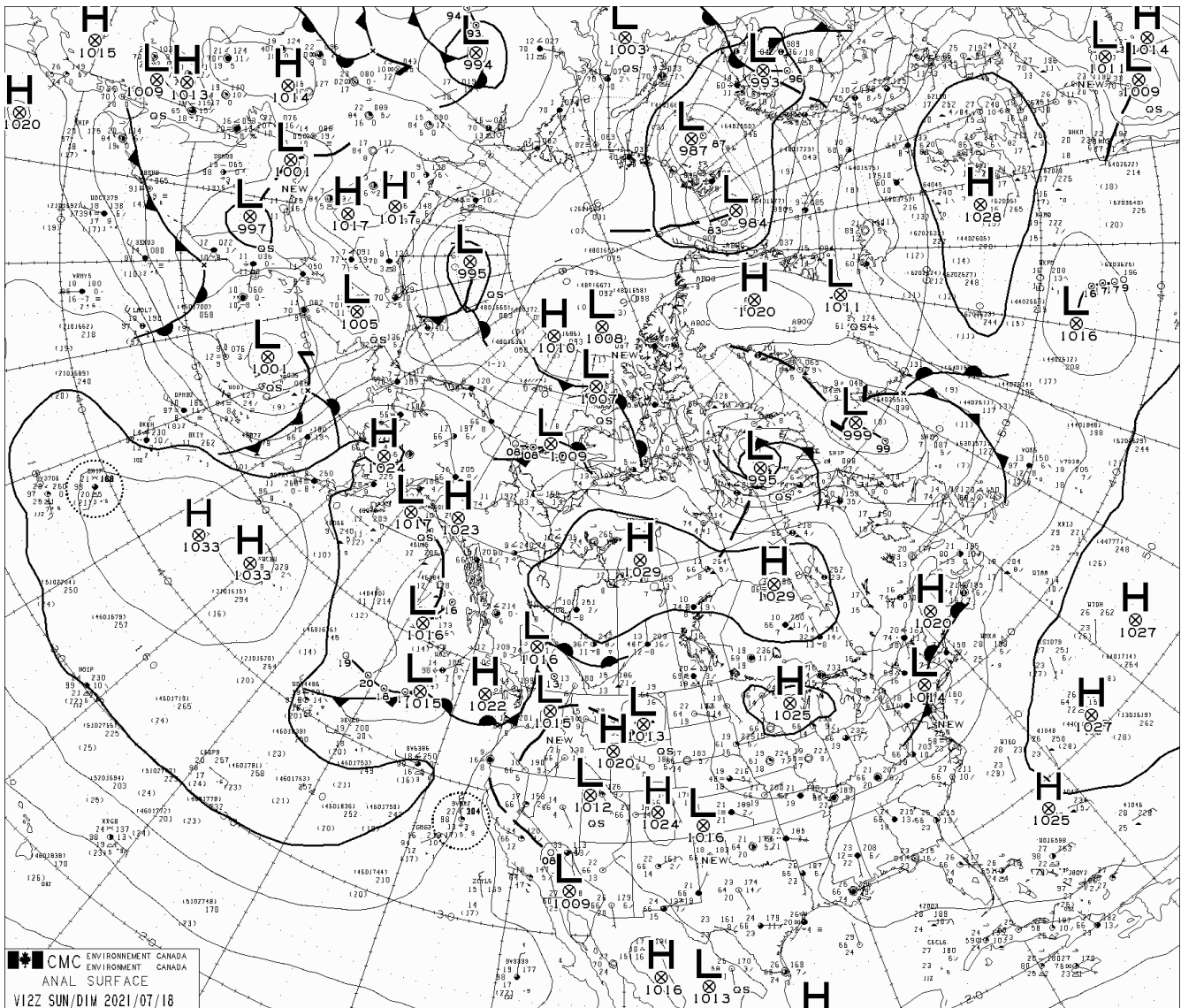


Figure 4.1. Complete surface analysis map for Sunday 18 July, 2021. H identifies the location of a high-pressure system; L identifies the location of a low-pressure system. The solid lines are isobars, lines of equal pressure. Source: Environment and Climate Change Canada [GIF] (https://weather.gc.ca/data/analysis/947_100.gif). Permission for non-commercial use (<https://www.canada.ca/en/transparency/terms.html>).

The weather map contains the following information:

1. Pressure systems:

- a. High-pressure systems are identified by an **H**, and low-pressure systems are identified by an **L**. High-pressure systems have pressure higher than average sea-level pressure, whereas low-pressure systems have pressure lower than mean sea-level pressure. Mean sea-level pressure is approximately 1013 mb (millibar).
- b. The solid thin lines on the map are isobars, lines of equal pressure.
- c. Dashed lines identify **troughs** and **ridges**, elongated areas of low- and high-pressure that extend from centres of low- and high-pressure respectively. To find troughs, look for places where isobars make a sharp bend around a low-pressure

system; ridges where this occurs around high-pressure systems. Note that these dashed lines are not provided on upper air analyses.

2. Station data: For each station in the network, cloud type, sea-level pressure, pressure change, wind direction and speed, air temperature and dew point temperature are provided. Refer to the key in Figure 4.2. You can use this information to identify warm and cold air. **Air masses** are vast bodies of air with the same properties.

SIMPLE STATION MODEL

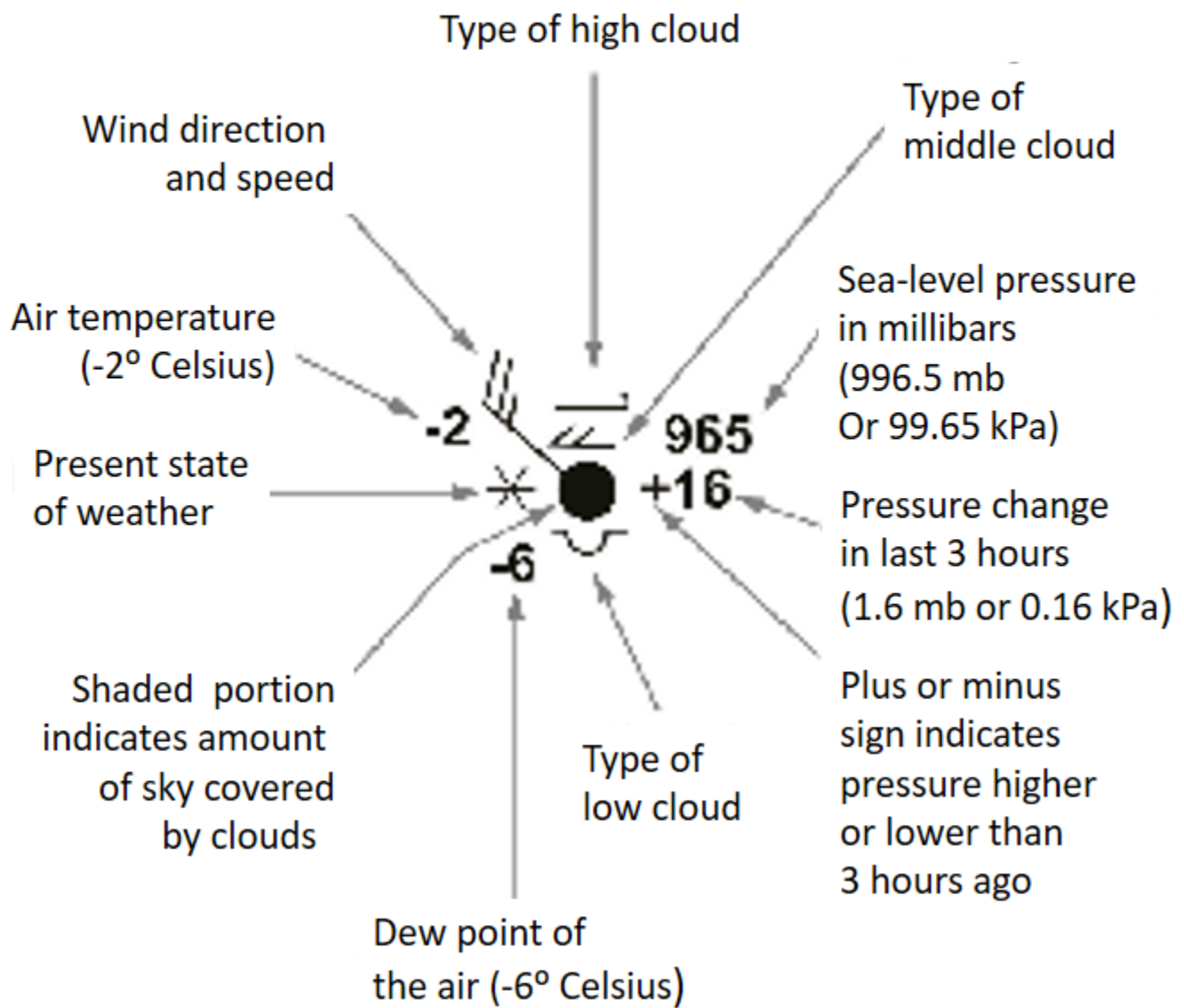


Figure 4.2. Key to weather station data on the weather map that is Figure 4.1. Source: Environment and Climate Change Canada. Permission for non-commercial use. (<https://www.canada.ca/en/transparency/terms.html>) [Image description]

3. **Fronts:** The thick solid lines with semi-circles and/or triangles attached indicate fronts, the locations where air masses meet. There are four types of fronts:
- Cold front – indicated by triangles pointing towards the direction of movement.
 - Warm front – indicated by semi-circles pointing towards the direction of movement.
 - Occluded front – indicated by triangles and semi-circles on the same side of the line.
 - Stationary front – indicated by semi-circles on one side of the line and triangles on the other.

On analyses of the upper atmosphere, e.g., at 250 hPa (hectopascal), you may also find a **J** identifying the location of the **jet stream**. Jet streams are fast flowing, narrow, meandering air. On Earth, the main jet streams are located near the altitude of the tropopause and are westerly winds. Their paths typically meander. They form the boundary between adjacent air masses with significant differences in temperature, such as the polar region and warmer air to the south.

Lab Exercises

In this lab you will

- Identify normal weather conditions for tomorrow.
- Construct a weather forecast through collection and analysis of temperature, precipitation, atmospheric circulation data and analyses.
- Write a script for your weather forecast that is suitable for presentation on radio.

With the exception of the script, this lab must be completed during class time, or at the time agreed with your instructor.

EX1: Climate and Weather

“Climate is what you expect, and weather is what you get” (Heinlein, 1973, p. 352). So, based on climate information, what should we expect tomorrow?

Step 1: Open the WeatherStats (<http://www.weatherstats.ca>) website to access climate data. Go to **List View** at the top-left of the page. Here there is a list of major Canadian stations, but you will find more places listed by province under the tabs at the top of the page. Note that the full list of stations may take a couple of minutes to load. Choose the place you wish to produce a forecast for, and click on it.

Step 2: You want the data for tomorrow, so click on **Time Warp** in the top-right of the weather dashboard page and enter tomorrow’s date in the **Date** box.

Step 3: Towards the bottom of the weather dashboard page is the **Daily Almanac**. This gives you the normal

expected weather for the selected date. Ideally this will be based on 30 years of data, but sometimes the data are for a shorter period. Your forecast will focus mostly on temperature and precipitation, so take a look at the normal maximum and minimum values of temperature and precipitation for tomorrow. Also look at the extreme values.

1. State the average and range of temperature and precipitation for tomorrow's date. You will need to calculate the range from the available data. This is a climate forecast for tomorrow, based on what's happened on tomorrow's date over the past 30 years. It is possible that these values will be exceeded, but it's also quite likely that temperature and precipitation tomorrow will fall in the range that you've just determined.

EX2: What's Been Happening in the Past 24 Hours?

Before we can predict the future weather, we need to know the current and recent weather. Return to today's date using the **Time Warp**.

You will find Current Conditions listed, plus the temperature changes over the past 24 hours.

2. Write a short paragraph on the current weather and changes over the past 24 hours. If you are or were at or close to that location then please add your own observations, e.g., **Although no rain was recorded, I felt a few drops as I waited for the bus outside City Hall at 10am.** Be sure to include the wind direction in your description.

EX3: Weather Radar

Weather radar is also on the same page. Weather radar is used to show regional precipitation patterns, and originates from ground stations. For example, there is one located at Silver Star Mountain Resort in Vernon, British Columbia. There are (or were) 31 stations in Canada, all located along the United States / Canada border, where most of the Canadian population is located.

The radar is shown as an animation and the times are at the bottom of the radar panel. These times are in UTC (see Weather Radar).

Answer the following questions:

3. When does the animation start and end (in UTC)?
4. When does the animation start and end in local time?
5. In 2-3 sentences, describe where precipitation is occurring, where it came in from, and where it appears to be headed. Does it look like any precipitation is headed towards the place you're interested in?

EX4: Satellite Imagery

All of the data on WeatherStats (<http://www.weatherstats.ca>) comes from Environment and Climate Change Canada. To get deeper into what's happening we will need to use the Environment and Climate Change Canada website (https://weather.gc.ca/index_e.html).

Step 1: On the Environment and Climate Change Canada website (https://weather.gc.ca/index_e.html), click on **Satellite**. Click on **GOES-East** if your location is in Eastern Canada or **GOES-West** if your location is in Western Canada.

Step 2: Click on **Visible**. This gives you visible light imagery, which is what you would see if you were looking down from the satellite. At the top of the image there is some information. The last bit will read something like, **13.20 UTC**. This is the UTC time of the image. In other words, this is data captured in the past few hours, but is not quite real time data. You can click on the image to enlarge it. Trick question: How many people are on board a weather satellite?

Step 3: Now try the animation feature. Click on the **Back** arrow to return to the Menu screen. Click on **Animation**. This feature links a series of six images taken at 10 minute intervals over the preceding hour. Control buttons (play, stop, fast forward, reverse) are located at the bottom of the image. You can also control the speed at which the images change with the **Speed** buttons.

Answer the following questions:

6. What is your local time of the latest image (converted from UTC)?
7. What is the time duration between the earliest and latest images in the animation, based on the UTC times of the images?
8. What does GOES stand for?
9. Explain the **G** in GOES.

EX5: Interpreting Satellite Imagery

The satellite imagery we've looked at so far is based on visible light. Return to the Menu screen. Now look at the **IR (10.7 μm)** and the **Visible & topography** images. The IR image gives the temperature of the clouds and surface. Note that the scale is counterintuitive, with red as the **coldest**.

Answer the following questions:

10. What cloud types can you identify near your forecast location using the visible and infrared images?
11. Looking at the animation of satellite images, where are the clouds moving from and to? Include known locations and the direction.
12. Identify locations near your forecast site where clouds are dissipating and areas where clouds seem to be growing.

13. Can you see any evidence of low- or high-pressure systems? Remember in the northern hemisphere a low pressure system rotates counter-clockwise.
14. Can you see any weather systems moving towards or away from your forecast location?

EX6: Surface and Upper Air Analyses

Go back to the Environment and Climate Change Canada website (https://weather.gc.ca/index_e.html). Scroll approximately halfway down the page and click on **Analyses and Modelling**. This is where you'll find links to professional weather maps and the models that forecasters use.

Click on the **Surface** located under the **Analyses** heading. Look at the most recent MSLP (mean sea-level pressure) chart first. Use the **Complete (Northern Hemispheric coverage)** maps, since these have the fronts marked on them. There are four versions of the charts: **00, 06, 12, and 18**. These are the UTC times. Click on each to view. You will see a date, as well as the time. Use the one that is most recent. You can enlarge the map by clicking anywhere on it so that you can read the numbers more clearly.

15. Locate the following features on the MSLP chart if present, and describe their location relative to your forecast area:
 - a. High- and low-pressure systems.
 - b. Areas of warm and cold air.
 - c. Different air masses.
 - d. Any fronts.

Return to the **Analyses** page. Scroll down to **Upper Air Analyses**.

16. Click on **500 hPa: Geopotential height, 1000-500hPa thickness** to view the most recent 500 hPa map. Where are troughs and ridges located relative to your forecast site?
17. Click on **250 hPa: Geopotential height, wind velocity** to view the most recent 250 hPa map. Where is the jet stream located relative to your forecast site?

EX7: Producing Your Forecast

Summarize your findings for your forecast location. Include the following information:

- Where are weather systems coming from?
- What are the temperatures and dew point temperatures like upstream of your forecast location?

- Based on the satellite images, what do you think the cloud cover will be like overnight and tomorrow? How will cloud cover influence the temperature?
- Will tomorrow's weather be different from today's weather? Why or why not? What major processes will determine tomorrow's weather?

Use this summary to write your forecast.

18. Write a script for your weather forecast that could be read on the radio. Be sure to include your predicted temperature, cloud cover, precipitation, and wind speed and direction.

Reflection Questions

1. Compare your forecast for tomorrow with the average and range of temperature and precipitation you obtained in EX1. What does this tell you about the difference between weather and climate?
2. Now that you have experience creating a weather forecast, would you like to do this professionally? What do you see as the major challenges?
3. Consider the types of decisions people make based on the weather forecast. Given your experience creating a weather forecast, do you believe that these decisions can be made confidently, and how far in advance?

References

Heinlein, R. A. (1973). *Time enough for love*. G.P. Putnam's Sons

Environment and Climate Change Canada. (n.d.). *About Canadian historical weather radar*. Government of Canada. <https://www.canada.ca/en/environment-climate-change/services/weather-general-tools-resources/radar-overview/about.html>. Accessed July 14, 2021.

Image Descriptions

Figure 4.2. Key to weather station data on the weather map

Example values are presented with a description of the type of value for each position around the central circle. Symbols are used to represent cloud type and cover, the current state of the weather, and wind speed and direction. Numerical values are provided for sea level pressure, pressure change, dew point of the air, and air temperature.

[Return to Figure 4.2]

Lab 05: Local Climate Data Analysis

Terence Day

Your friend is getting married, congratulations to them! And because they know you've become an expert on physical geography, they'd like you to help them choose between two possible places for the wedding. It is currently planned for June 21. The two places under consideration in BC are the lovely Stanley Park near Vancouver Harbour, and a delightful winery near Okanagan Centre. The ceremony will be held outdoors early- to mid-afternoon (the hottest time of day). Based on the climate, where would you advise your friend to get married?

In this lab you will use a variety of statistical analyses to answer questions on the best, most dependable climate to hold a wedding. The techniques are all used by physical geographers in a range of different applications, not just in the planning of weddings.

Learning Objectives

After completion of this lab, you will be able to

- Obtain historical Canadian climate data using the Environment and Climate Change Canada website.
- Calculate and interpret a mean (average).
- Calculate the probability of extreme events occurring.
- Construct and interpret graphs showing local climate trends.

Pre-Readings

Climatology

Climatology is the study of climate through long-term weather patterns. When examined over time and space, areas with similar weather statistics can be identified, and are called climate regions. A **Climate Normal** is a 30-year (for example, 1981-2010, 1991-2020) average of climate conditions at a particular location. Climate Normals are used to for planning purposes and to determine official governmental policies at a larger scale.

Summary Statistics and Probability

Understanding of the following terms/concepts is required in order to complete this lab:

- Mean or average.
- Probability.
- Data trends.

Types of Graphs and How to Create Them

Line graphs are generally used to show continuous data, or something that is a property, e.g., temperature changes over time. Graphs have a horizontal axis (x-axis) and a vertical axis (y-axis). An easy way to remember this is **y to the sky**. Generally, the convention is that the x-axis is the independent variable and the y-axis is the dependent variable. In the case of temperature graphs, the temperature (the dependent variable) depends on the month (the independent variable). The month doesn't depend on the temperature.

Bar graphs present data as vertical or horizontal bars that are proportional in length to the value of something. They are used to show discrete or discontinuous data. For example, a bar graph is a good way to show the amount of precipitation that occurred over specific units of time. For example, when plotting Climate Normal precipitation, there will be one bar for each year, and the length of each of the 30 bars is proportional to the amount of precipitation that falls each year.

Drawing graphs is fairly easy by hand, but more professional-looking graphs can easily be constructed using your laptop or other device. We will be practicing creating charts in Google Sheets, here, or you can use Microsoft Excel or other spreadsheet program.

In order to be sure that the data you are presenting makes sense to other people (or yourself later on) and is useful for your analyses, it is important to include some extra information, in addition to the data itself. Here is the **checklist for graphs**:

- Is the x-axis the independent variable?
- Are both axes labelled and do they include appropriate units (e.g., °C for temperature, mm for precipitation)?
- Does the graph have a descriptive title or figure caption?
- Do the size and scale of both axes on the chart make sense – not cramped up, nor too much white space? Can you view the data clearly?

Lab Exercises

In this lab you will collect historical climate data from the Environment and Climate Change Canada website, and analyse the data using statistical techniques in order to determine the probability of certain weather conditions (precipitation, extreme heat) occurring at the time of your friend's wedding. You will also use statistical methods to assess whether or not precipitation and temperature have changed over the past 30 years, and reflect on how this may affect the recommendation you are making to your friend.

A Worksheet is provided for you to complete as you work through the lab exercises. Your instructor will provide you with instructions on how to submit it once complete.

EX1: Identifying Mean (Average) Conditions

First, you need to collect some data to help with your recommendations. Specifically, you need data for 30 years to obtain a Climate Normal (e.g., 1991 – 2020) for June 21. In this exercise you will collect Maximum Temperature (°C) and Total Precipitation (mm).

You will have to get the record for each year individually.

Step 1: Open the Environment and Climate Change Canada website (https://climate.weather.gc.ca/historical_data/search_historic_data_e.html).

Step 2: Once you are on the website, search for your site by typing the name in the **Name** box.

Step 3: Select **daily** as the **Data Interval**. Change the **year** to **2020** and select **June** for the **month**. The days will become greyed out – you will be given the entire month. Click **Go**.

Step 4: On the data page, scroll down to June 21 to see the data you need. If you have a smaller screen but would like to see the column headings with the data, you can reduce the size of the font by clicking **<Ctrl><->** on your keyboard. Once you have recorded the information you need, change the **year** using the drop-down menu at the bottom of the page. Continue this process until you have all your data.

1. Collect the data and add it to Table 5.1. The data for Vancouver Harbour are provided, as is the data for Okanagan Centre for 2020 (but check to make sure that it is correct). Bear in mind that there may be some missing data; if it's missing then insert a dash (-). If precipitation is marked **T** then that means that there was just a trace. Enter the **T** on the table, but count is as zero in the calculation of the mean. Note that there is no data available at Okanagan Centre for 2019, but there is for all other years.

Table 5.1. Vancouver Harbour and Okanagan Centre Maximum Temperatures and Total Precipitation for June 21, 1991 – 2020

	Vancouver Harbour	Vancouver Harbour	Okanagan Centre	Okanagan Centre
Year	Maximum Temperature (°C)	Total Precipitation (mm)	Maximum Temperature (°C)	Total Precipitation (mm)
2020	20.7	0.0	27.0	0.0
2019	22.5	0.0	–	–
2018	22.0	0.0		
2017	19.6	0.0		
2016	18.5	15.6		
2015	24.8	0.0		
2014	19.7	–		
2013	18.1	1		
2012	21.0	0.0		
2011	–	–		
2010	16.3	–		
2009	18.3	0.2		
2008	20.7	0.0		
2007	22.1	0.2		
2006	20.4	–		
2005	23.4	6.0		
2004	27.8	0.0		
2003	17.7	–		
2002	25.9	0.0		
2001	24.9	0.0		
2000	21.5	0.0		
1999	17.9	2.8		
1998	23.5	0.2		
1997	16.6	21.8		
1996	22.8	0.0		
1995	20.1	0.0		

	Vancouver Harbour	Vancouver Harbour	Okanagan Centre	Okanagan Centre
1994	23.7	0.0		
1993	16.3	3.2		
1992	28.4	0.0		
1991	16.1	0.2		
Mean				

2. Calculate the mean value for each variable at both locations, and fill in the bottom row of Table 5.1. The mean can be calculated in Excel or Google Sheets using the expression **=average(data)**, or you can calculate it by hand.
3. What are these numbers telling you about whether or not it is a good idea to hold the wedding at Vancouver Harbour vs. Okanagan Centre? (1 – 2 sentences)

EX2: Examining the Probability of Rain or Extreme Temperatures

With your friend's comfort in mind, you will want to make sure that the probability for rain and ridiculously hot or cold temperatures is low. Based on the 30-year record you have created, it is possible to calculate these probabilities.

If we take the number of days that it rained over the 30-year normal period, and then calculate the percentage of times that it rained, then we know the probability of it raining on June 21. To do the calculations you will need to know how many years it rained. When doing the calculation **do not include any years for which there is no record**.

For example, suppose that it rained on that day 3 years out of 30, then

$$\frac{3}{30} \times 100\% = 10\%$$

If on the other hand you only had 27 years of record and it rained on 3 of them then the probability would be

$$\frac{3}{27} \times 100\% = 11.1\%$$

Your friend **really** doesn't want it to rain on their wedding day, so even though the rain wasn't measurable, count days with "Trace" rain as rainy days.

You also want to make sure that the temperatures aren't too hot nor too cool. More specifically, your friend does not want the temperature to be over 30 °C, nor under 20 °C. To do the calculations you need to know how many days out of the 30-year record the temperatures were higher than 30 °C or were below 20 °C.

Use these guidelines to determine answers to the following questions. **Show your work.**

4. Based on what has happened over the past 30 years, what is the probability of it raining on June 21 at
 - a. Vancouver Harbour?
 - b. Okanagan Centre?
5. Based on what has happened over the past 30 years on June 21, what is the probability of temperatures
 - a. exceeding 30 °C at Vancouver Harbour?
 - b. being less than 20 °C at Vancouver Harbour?
 - c. exceeding 30 °C at Okanagan Centre?
 - d. being less than 20 °C at Okanagan Centre?
6. Based on your responses to the above questions, what are your conclusions about where to hold the wedding? (2 – 4 sentences)

EX3: Have Precipitation and Temperature Changed Over the Past 30 Years?

When we calculate probabilities based on what has happened in the past, then we assume what statisticians call **stationarity**. Stationarity is an assumption that variations in measurements are due to random fluctuations, and are not associated with any systematic change. However, it is possible that there is some underlying pattern of climate change. One simple way of examining that is to graph the data over time. Here we will use bar graphs for precipitation and line graphs for temperature.

In this exercise, you will plot the total monthly precipitation and mean daily maximum temperature for June for Vancouver Harbour. Has it changed over the past 30 years? For your convenience, the data is listed in Table 5.2.

Table 5.2. Total June precipitation and mean daily maximum over 30 years at Vancouver Harbour

Year	Total June Precipitation (mm)	June Mean Daily Maximum Temperature (°C)
1991	53.6	25.5
1992	96.4	28.8
1993	72.2	23.3
1994	70.5	25.0
1995	43.4	28.6
1996	13.6	23.2
1997	94.8	23.5
1998	29.8	25.9
1999	83.1	27.4
2000	57.0	27.5
2001	60.4	25.4
2002	30.8	30.2
2003	12.8	26.6
2004	22.8	28.3
2005	49.6	24.3
2006	25.2	26.2
2007	80.0	27.4
2008	43.0	26.9
2009	10.8	25.9
2010	48.4	23.1
2011	41.0	22.1
2012	76.8	22.0
2013	45.8	31.2
2014	36.8	23.7
2015	11	28.3
2016	58.2	25.2
2017	46.4	26.2
2018	38.8	26.8

2019	26.2	29.9
2020	53.2	24.1

7. Construct a bar graph of June precipitation at Vancouver Harbour for the period 1991 – 2020.
 - a. Copy and paste Table 5.2 into Google Sheets or Excel.
 - b. Select the **Year** and **Total June Precipitation** columns and click on **Insert/Chart/Column**.
 - c. Check that your labels, title, and axis are correct using the checklist for graphs and copy and paste your graph into your Worksheet.
8. Construct a line graph of June mean daily maximum temperature at Vancouver Harbour for the period 1991- 2020.
 - a. Select the **Year** and **June Mean Daily Temperature** columns and click on **Insert/Chart/Line**.
 - b. Check that your labels, title, and axis are correct using the checklist for graphs and copy and paste your graph into your Worksheet.
9. Are there any trends here? Your opinion will be a little subjective, but try to be as objective as possible. There are world-wide datasets that show warming trends. Explain your results in this world-wide context. (2 – 4 sentences)
10. In the context of climate change, is the average for the past 30 years a good way to estimate the probability of what will happen next year? On the basis of climate trends you identified, do you have any reason to adjust your thinking about the probability of rain or extreme temperatures in Vancouver? (2 – 4 sentences)

Reflection Questions

Please take 15 minutes to consider the following questions. You can type your responses into your Worksheet.

1. Now that you have some experience calculating means, can you think of another use for this new skill of yours?
 - a. Describe a scenario where calculating the mean could help you make a decision in your life. Include a description of the data you would need to collect to help inform your decision.
 - b. How long would you need to collect the data for in order for the mean to be representative? Explain your reasoning.
2. In EX3 you assessed trends in climate data based on one relatively small set of data. What type of data would you need to see larger trends?

Worksheets

Return to EX1

- Lab 5 Worksheet [Word] (<https://pressbooks.bccampus.ca/geoglabmanualv2/wp-content/uploads/sites/1340/2020/07/Lab-5-Worksheet.docx>)
- Lab 5 Worksheet [ODT] (<https://pressbooks.bccampus.ca/geoglabmanualv2/wp-content/uploads/sites/1340/2020/07/Lab-5-Worksheet.odt>)
- Lab 5 Worksheet [PDF] (<https://pressbooks.bccampus.ca/geoglabmanualv2/wp-content/uploads/sites/1340/2020/07/Lab-5-Worksheet.pdf>)

Lab 06: Climate Analysis with Virtual Globes

Andrew Perkins

How have scientists come to the conclusion that global climate is rapidly changing? It's based on the scientific method and repeated hypothesis testing. Specifically, by observing global temperature and precipitation records over the long term and looking for significant change. While atmospheric conditions have been subtly changing for decades, we've only been consistently and directly measuring key climate indicators like atmospheric carbon dioxide levels since the 1960's. However, the widespread existence of weather stations around the world, with regular, reliable weather observations, allows us to go further back in time to see the pattern of changing climate over the last century and beyond.

In this lab, you will explore the underlying causes of changing climate, human contributions to this, and analyze actual temperature records from some of the longest running weather stations in Canada to determine if they demonstrate a trend in changing climate over time. At the end of this lab, you will have a good sense of one line of evidence for contemporary climate change.

Learning Objectives

After completion of this lab, you will be able to

- Read and graph monthly average temperatures by decade from historical data sources.
- Analyze trend lines in graphed data for change over time.
- Interpret histograms.
- Understand the basis in data for modern climate change.

Pre-Readings

What Causes Earth's Climate to Change Over Time?

Atmospheric gases play a significant role in maintaining a global energy balance. Through transmission, reflection, absorption, and refraction they affect radiation emitted by the sun as it travels to and from Earth's surface. Energy from the Sun comes as shortwave energy at the UV and visible end of the electromagnetic spectrum. Energy re-emitted from Earth is much lower in temperature and has a longer wavelength. Some of the re-emitted longwave radiation from Earth is temporarily trapped within the atmosphere before it escapes back into space, resulting in heat retention. This is known as the **greenhouse effect** (Figure 6.1).

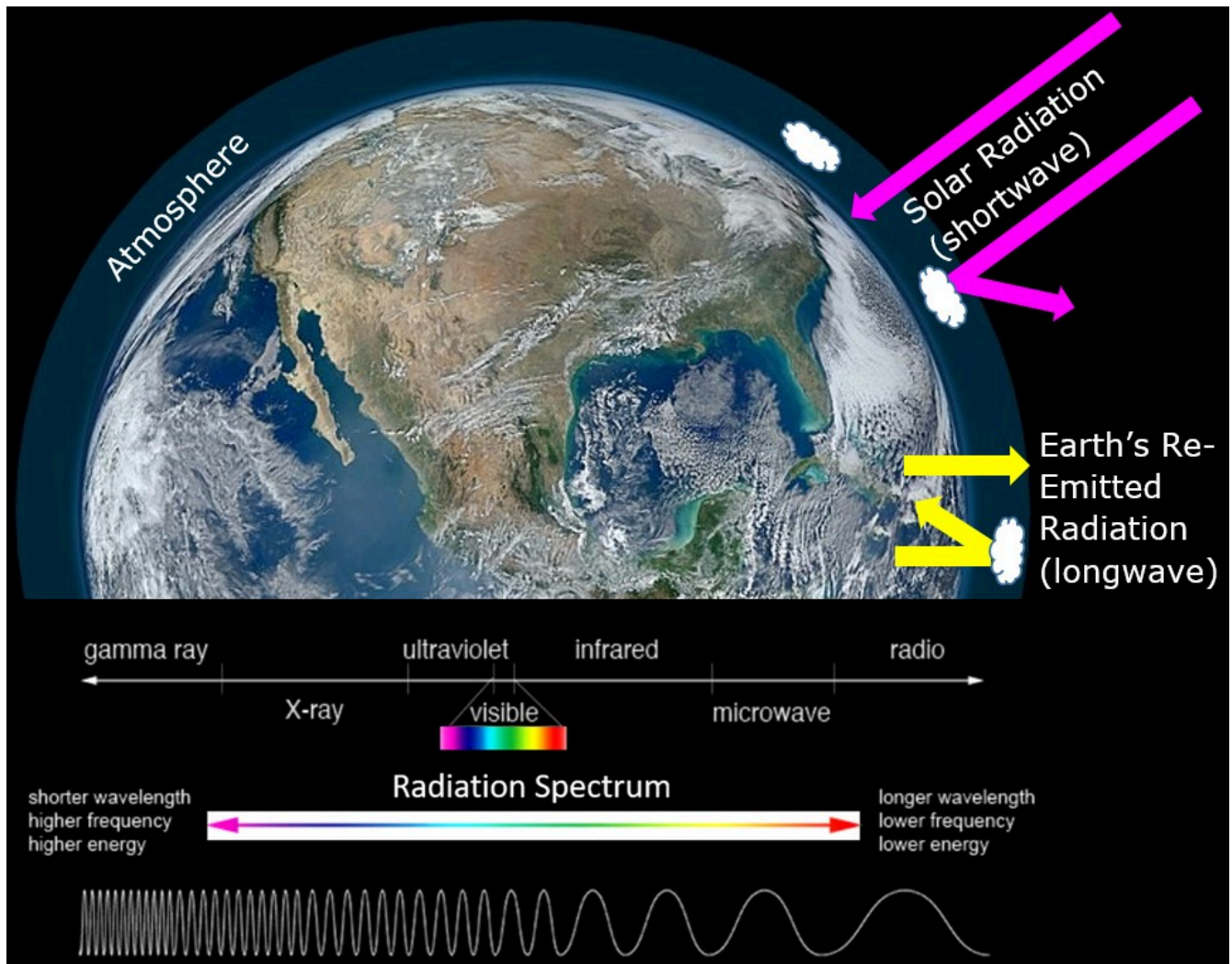


Figure 6.1. Overview of the greenhouse effect, demonstrating some of the radiation re-radiated by Earth is reflected back to Earth's surface by components of the atmosphere. Source: A. Perkins and S. MacKinnon. CC BY-NC-SA 4.0. Images by NASA (Public Domain). [Image description]

The differing wavelengths (commonly measured in micrometres, μm) between incoming solar radiation and outgoing radiation re-emitted by Earth allow atmospheric gases to play specific roles in controlling the transmission of these wavelengths. For example, water vapour (H_2O), absorbs mostly energy in the longwave end of the spectrum, blocking energy re-emitted from Earth (Figure 6.2). In contrast, oxygen (O_2) and ozone (O_3), absorb mostly energy in the shortwave end of the spectrum (high-energy incoming solar radiation). This difference – where high-energy radiation is passed through the atmosphere, but lower energy radiation is prevented from escaping – permits the greenhouse effect, which is what creates the conditions (climate) that allow life as we know it to exist on Earth.

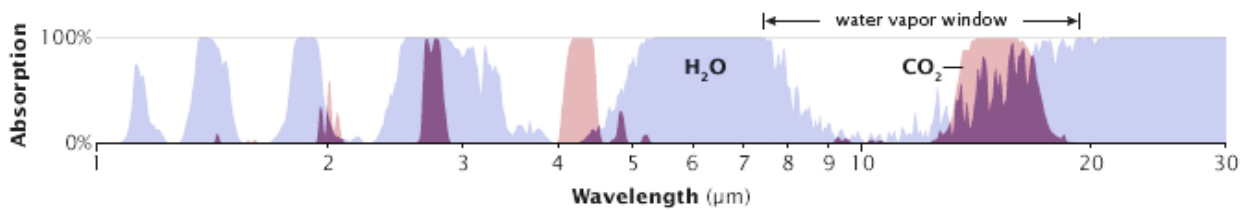


Figure 6.2. The atmospheric window, demonstrating percent absorption of radiation by water (H_2O) in blue and carbon dioxide (CO_2) in pink. Wavelengths in white areas of graph are not affected by water or carbon dioxide in the atmosphere. Source: R. Rohdes. NASA Earth Observatory (<https://earthobservatory.nasa.gov/features/EnergyBalance/page7.php>).

So, the greenhouse effect is the basic process that underpins the global climate. Changes to the climate system do occur as a result of natural and anthropogenic (manmade) changes that affect how much energy enters or leaves Earth's system, in other words, activities that affect Earth's energy budget. These changes are known as climate forcings, and are outlined in Climate Forcings and Global Warming (<https://earthobservatory.nasa.gov/features/EnergyBalance/page7.php>).

Carbon dioxide (CO_2) is a gas that is very effective at absorbing long-wave radiation. Figure 6.2 shows that CO_2 absorbs thermal radiation at a wavelength that water vapour does not. This is known as **closing the atmospheric window**, and is a reason that CO_2 concentrations in the atmosphere play a large role in forcing the climate. One of the first scientific stations to measure CO_2 concentrations over long periods is still operational at Mauna Loa in Hawai'i. To check it out, go to Keeling Curve of Carbon Dioxide Concentration at Mauna Loa Observatory (<https://keelingcurve.ucsd.edu/>). The data recorded here have allowed us to track detailed changes in carbon dioxide concentrations over time. These concentrations are usually measured in parts per million (ppm) where 1 ppm CO_2 represents one CO_2 particle per million atmospheric particles.

Since initial measurements at Mauna Loa began, we have augmented our understanding of global CO_2 concentrations with more measuring stations and satellite measurements. This has allowed us to see a spatial distribution in CO_2 emissions across the globe, and also better understand the global energy budget.

For an interesting way to visualize the pathway of escaping longwave (infrared) radiation, check out the Infrared Escape Game (<https://atmos.uw.edu/~dargan/EarthGamesUW/InfraredEscape/>). See how the difficulty of this game changes between atmospheric concentrations of CO_2 in the 1900s to expected concentrations in 2025.

Measuring Spatial Variation in Earth's Energy Budget

When Earth's energy budget is out of balance, global temperatures start to rise or fall. When this happens, ecosystems need to adjust which, depending on the rate of change, can be difficult to accomplish.

One way to analyze change in countries around the world is by using temperature records that extend into the historic past. Canada has several sites for which daily temperature records cover at least a 100-year period. These data are archived by Environment and Climate Change Canada (https://climate.weather.gc.ca/index_e.html). Others have organized this data into virtual globes (<http://thesis.allenkoren.com/>) to make it easier to explore.

The data collected from these locations is incredibly valuable for reconstructing changes in temperature over time, and analyzing how changes might be different at separate locations around the globe. This reinforces the importance of keeping consistent long term scientific datasets for the good of society in general, so we can better understand the systems we inhabit.

Since the 1970's, space-based measurements have been possible from satellites that are measuring atmospheric and surface conditions on Earth. ERBS (Earth Radiation Budget Satellite) launched in 1984 and collected data on Earth's radiation budget. One of the modern satellite systems to take over this role is CERES (Clouds and Earth's Radiant Energy System) (Figure 6.3).



Figure 6.3. Left: Earth Radiation Budget Satellite. Right: Clouds and Earth's Radiant Energy System. Source: K. Panchuk (2020). CC BY-NC-SA 4.0. ERBS (<https://eosps.nasa.gov/missions/earth-radiation-budget-satellite>) and CERES (<https://terra.nasa.gov/about/terra-instruments/ceres>) images by NASA (Public Domain).

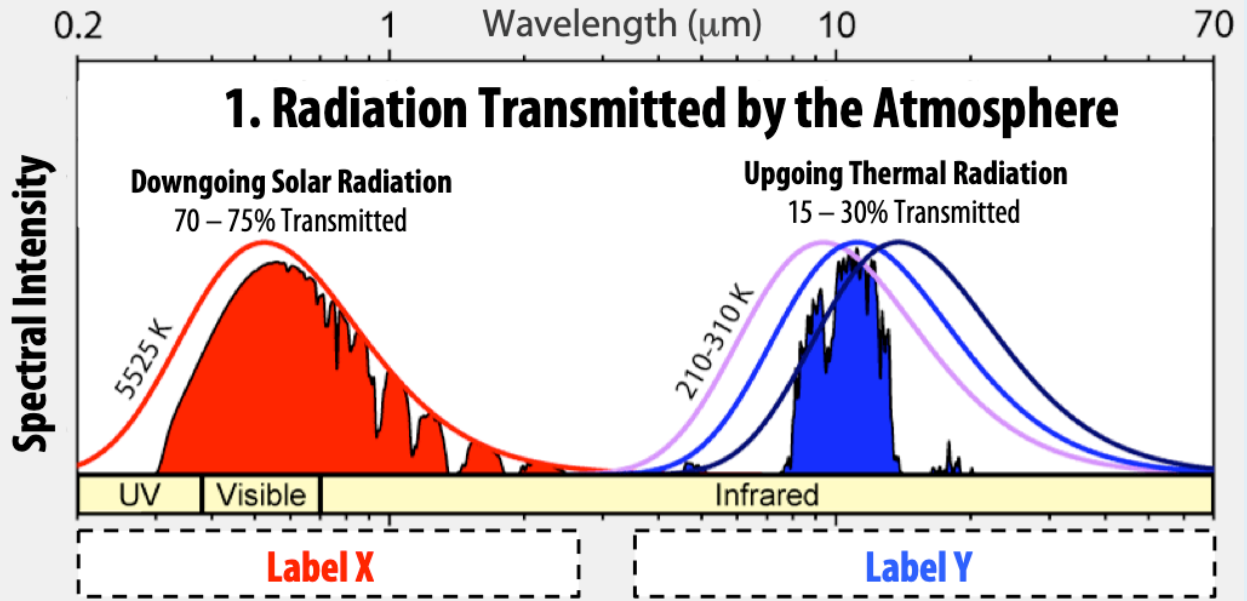
Lab Exercises

In these exercises you will

- Review the greenhouse effect and the basis for contemporary climate change.
- Analyze the pattern of carbon dioxide concentration in the atmosphere over recent decades.
- Observe and graph temperature trends from several Canadian weather stations over at least a century of time using this virtual globe (historical temperature data). (<http://thesis.allenkoren.com/>)
- Determine how the long term patterns of your analyzed weather stations fits in to the broader pattern of Canadian weather station observations by comparing values to long-term Climate Normals.

EX1: Solar Radiation and the Atmospheric Window

Figure 6.4 shows a detailed view of the atmospheric window. Part 1 shows spectral intensity of the radiation. Part 2 is a two-part graphic with the complete picture of absorption/scattering (gray) and transmission (white) at the top, and the absorption/scattering and transmission separated into individual atmospheric components at the bottom.



2. Absorption & Scattering of Radiation

Absorbed/ Scattered Wavelengths
 Transmitted Wavelengths

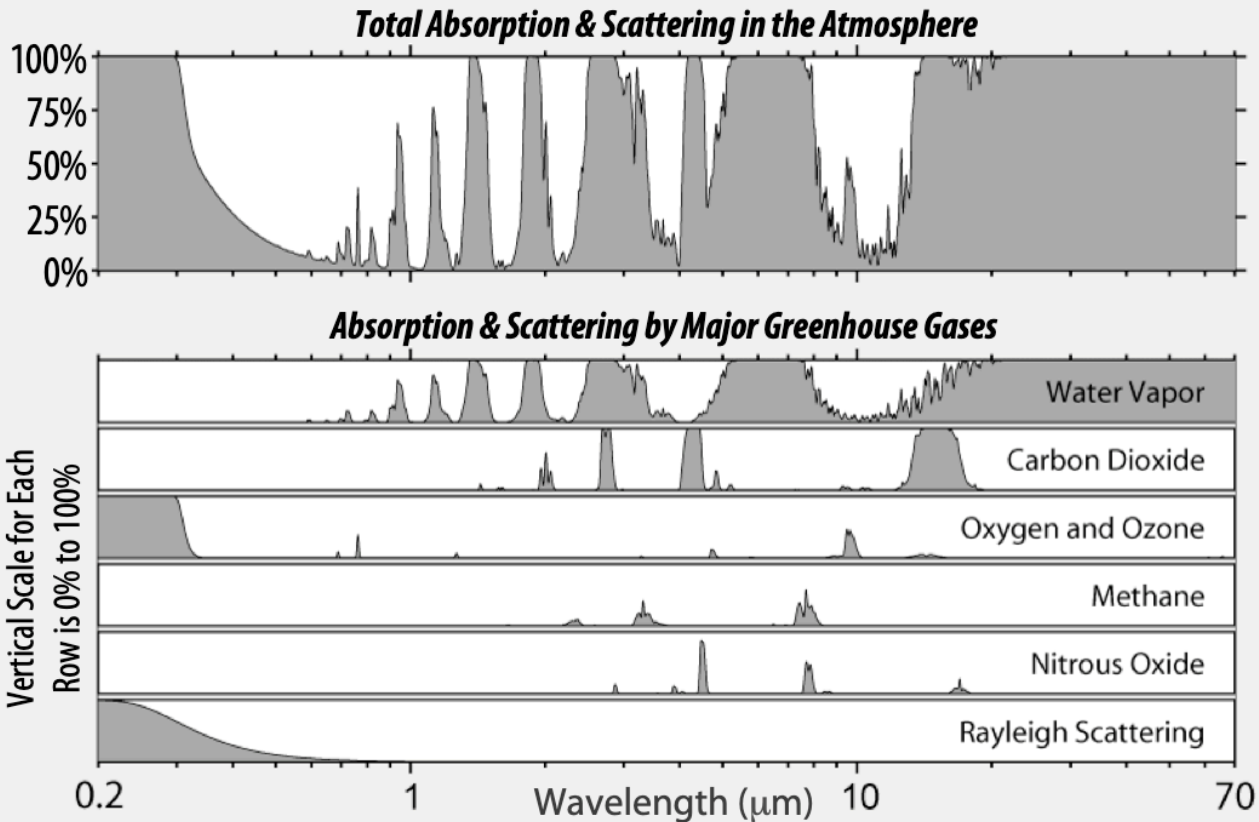


Figure 6.4. Atmospheric window. Part 1: Spectral intensity of radiation transmitted by the atmosphere. Part 2: Percentage of absorption/scattering (gray) and transmission (white) plotted against wavelength at the top, and the percentage absorption/

scattering and transmission separated into individual major greenhouse gases at the bottom. Source: K. Panchuk (2020) CC BY-SA. Adapted from R. Rohdes, *Atmospheric_Transmission* (https://commons.wikimedia.org/wiki/File:Atmospheric_Transmission.png), CC BY-SA [Image description]

1. There are spaces for two labels, *Label X* and *Label Y* under the first graph. Which of these labels should be **shortwave** and which should be **longwave**?
2. What is the range of transmitted wavelengths for downgoing radiation coming from the Sun (indicated by the solid red shading)? Give your answer in micrometers (μm).
3. What is the range of transmitted wavelengths for upgoing radiation released from Earth's surface (indicated by solid blue shading)? Give your answer in micrometers (μm).
4. Does a greenhouse gas like carbon dioxide (CO_2) absorb mostly longwave or mostly shortwave radiation?
5. Water vapor also acts as a greenhouse gas, yet it is not often talked about in the media with respect to climate change. Why are scientists more concerned about the impact of CO_2 in the atmosphere than water vapor? Provide two reasons.
6. Look at the monthly averages for atmospheric CO_2 measured at Mauna Loa, Hawai'i (<https://www.esrl.noaa.gov/gmd/ccgg/trends/graph.html>).
 - a. What was the maximum CO_2 concentration measured in 1960?
 - b. What was the maximum CO_2 concentration measured in 2017?
7. Based on the information in the previous questions, how much has CO_2 concentration increased on average per year?
8. Look at the graph demonstrating the growth rate of CO_2 in our atmosphere as measured at Mauna Loa, Hawai'i (<https://www.esrl.noaa.gov/gmd/ccgg/trends/gr.html>). 10-year averages are indicated by the black horizontal lines on the graph:
 - a. What was the average yearly increase in carbon dioxide at Mauna Loa over the decade of the 1960s?
 - b. What was the average yearly increase in carbon dioxide at Mauna Loa over the decade of the 2000s?
 - c. According to this graph have humans been successful in reducing the rate of carbon dioxide accumulation in the atmosphere?

EX2: Human Contributions of CO_2 to the Atmospheric Reservoir

We know that there are many natural sources of CO_2 emissions that contribute to the atmospheric CO_2 reservoir. To better visualize the human contribution, we need to separate the human-generated component from the natural sources.

Imagine a world where the only contributions to CO_2 in the atmosphere are from people (in this scenario, natural/non-human sources of CO_2 do not exist). How much CO_2 would build up in the atmosphere every

year, simply from human activities like burning fossil fuels? This is exactly what the animation CO₂ from Fossil Fuel Combustion (<https://www.esrl.noaa.gov/gmd/ccgg/trends/ff.html>) (below) shows us, for the years 2011 and 2012. Watch the animation and pay special attention to the geography of the emissions. In particular, notice where the main sources of fossil fuel emissions are located, and how that relates to population distribution. A map of population density is available at Our World in Data – Population Density (<https://ourworldindata.org/most-densely-populated-countries>).



An interactive H5P element has been excluded from this version of the text. You can view it online here: <https://pressbooks.bccampus.ca/geoglabmanualv2/?p=71#h5p-43> (<https://pressbooks.bccampus.ca/geoglabmanualv2/?p=71#h5p-43>)

9. Which hemisphere has a higher buildup of carbon dioxide? Why do you think this is the case?
10. List three significant source regions for carbon dioxide release.
11. Describe one impact that global circulation patterns have on distributing atmospheric carbon dioxide around the globe.

EX3: Changing Temperatures in Canada Over the Last Century

Your instructor will assign you **one** of the four weather stations in Table 6.1 for analysis between 1880 and 2010.

Table 6.1 Weather Stations for Analysis

Number	Weather Station ID	Weather Station Name
1	403719130000	Churchill, Manitoba
2	403718690000	Prince Albert, Saskatchewan
3	403716000000	Sable Island, Nova Scotia
4	403718360000	Moosonee, Ontario

Step 1: Open the virtual globe (<http://thesis.allenkoren.com/>). Explore the data available and how to use the time slider at the bottom of the globe. Some brief instructions:

- Runs best with Google Chrome.
- 60 MB of temperature data is used so the initial download may be slow.
- Click and drag to rotate the globe.
- Scroll to zoom in and out.

- The timeline is animated with the spacebar or play button.
- Clicking the timeline slider also allows you to move through time.
- Shift-click-drag on the globe to select a region on the map and generate temperatures for the histogram.
- Use the *Search* tool (magnifying glass in top-right corner) to find individual weather stations.

Step 2: Enter your station name into the **Search** tool and confirm the station ID once you zoom to the station (indicated by a filled circle). Note that the Moosonee, ON station is the only one that existed in 1880. If you have been assigned one of the other stations, they will not appear on your map until they were set up.

Step 3: Open an Excel spreadsheet. Set up a table in which you can enter the data you collect. Your table will have three columns: Year, January Temperature (°C) and July Temperature (°C).

Step 4: Return the Virtual Globe to 1880 using the **timeline slider**. You can check the month and year in the circle control in the bottom-left of the screen.

Step 5: Read the temperature from the information box in the top-right of the screen, and record in your table. Move to the next timestep (July 1880) using the **play button** or the **timeline slider**. Record the temperature value in your table. Repeat until you have collected all your data.

- Record the January and July temperatures for your station every 10 years, starting in January 1880 and continuing until July 2010. If there is no data, leave the cell blank.
- Graph the results of your table using a line graph with markers.
 - Place the year on the x-axis.
 - Use the left y-axis for the January temperature range and right y-axis for the July temperature range. In Excel, right click on the July data series, select **Format Data Series** then select **Plot Series On > Secondary Axis**.
 - Make sure that you can distinguish between the lines for January and July temperatures, and that a legend is included to guide other viewers.
 - Add axis labels with units and a descriptive title.
 - Check that the scale of each axis allows you to see the detail you need in the graph.
- Analyze the data:
 - Draw a best fit trendline through each series. To do this in Excel, right click on the data series one at a time and select **Add Trendline**. Leave the trendline as a linear trendline.
 - Determine the slope of the trendlines for January and July.
 - Is the temperature at your station undergoing a warming or cooling trend, or does it appear neutral?

Table 6.2. 1981 – 2010 Climate Normals Station Data. Source: Environment and Climate Change Canada (<http://climate.weather.gc.ca>)– Accessed May 2018

Daily Average Temperature	Jan	Feb	Mar	Apr	May	Jun	Jul	Aug	Sep	Oct	Nov	Dec
Churchill, Manitoba	-26	-24.5	-18.9	-9.8	-1	7	12.7	12.3	6.4	-1.2	-12.7	-21.9
Prince Albert, Saskatchewan	-17.3	-13.8	-6.8	3.3	10.4	15.3	18	16.7	10.5	3.1	-7.2	-14.8
Sable Island, Nova Scotia	-4.1	-3.6	-0.2	4.9	10.1	15.2	18.8	19.1	15.5	9.9	4.8	-0.8
Moosonee, Ontario (James Bay)	-20	-17.5	-11.1	-1.8	6.8	12.2	15.8	14.9	10.5	3.8	-4.3	-14.5

15. Obtain the Climate Normals for January and July for your station from Table 6.2. Add lines representing these values to your graph of temperatures.

One way to add the lines to your graph in Excel is to add two columns to your data table, one for each month of interest, and enter the Climate Normal value for all years. Right click on your graph and select **Select Data**. Click **Add**, and fill the three cell ranges. Ensure that the July Climate Normal plots on the right y-axis.

16. What is the difference between the average temperature from your first three temperature readings, and the 1981-2010 Climate Normal? Show your work for
- January
 - July

Reflection Questions

- Measurements of temperature at weather stations around the globe are some of the best long-term indicators of climate conditions at a specific location.
 - What factors do you think could impact the reliability of the measurements from an individual weather station?
 - How does considering the temperature records across many weather stations over a long period of time help increase confidence that the trends in a climate record reliably reflect actual conditions?
- How do you think the climate trends you observed at your weather station are affecting the biogeography and ecosystem health of that location?
- The recent collapse of a diesel storage tank (<https://theconversation.com/a-20-000-tonne-oil-spill-is-contaminating-the-arctic-it-could-take-decades-to-clean-up-141264>) in northern Russia

released approximately 20,000 litres of diesel fuel into a sensitive Arctic river system. The resource company that owned the storage tank has blamed melting permafrost for destabilizing the foundation of the tank, leading to its failure.

- a. Are climate-change related hazards something we should be more aware of (and private corporations should be responsible for monitoring) as we observe accelerating changes in some areas of the globe, like the Arctic?
- b. Is it reasonable that a company focused on resource extraction is blaming an oil tank failure on melting permafrost and suggesting the company itself is not to blame for the failure? Explain.

Image Descriptions

Figure 6.1. Overview of the greenhouse effect

There is a satellite image of the Earth showing incoming shortwave radiation from the Sun, represented as pink arrows. Some of this radiation bounces off the atmosphere, and some makes it to the Earth's surface. At the Earth's surface yellow arrows show longwave radiation re-emitted back out to space, a small amount of which is bounced off of Earth's atmosphere and back to the surface. Below this, the electromagnetic spectrum is shown, demonstrating different wavelengths of light and their associated energy. Shorter wavelength light including X-rays are on the left side of the diagram, visible light is in the middle and long wavelength light, including infrared is on the right side of the diagram.

[Return to Figure 6.1]

Figure 6.4 Atmospheric window.

The diagram is made of two graphs. On the upper graph, the x-axis shows wavelength of energy and the y-axis shows the energy intensity measured in the atmosphere. Two peaks are shown, a red one centred around shorter wavelengths and a blue one centred around longer wavelengths. The lower graph shows different atmospheric gases and their ability to absorb or transmit radiation of different wavelengths. Percent transmission through the atmosphere is shown on the y-axis and wavelength is shown on the x-axis. Areas of white on the graph show transmission of specific wavelengths and areas of gray on the graphs show absorption and blocking of wavelengths by specific gases. Graphs are shown for Water Vapour, Carbon Dioxide, Oxygen and Ozone, Methane, Nitrous Oxide, and Rayleigh Scattering. A cumulative graph of all of these gases and their transmission of radiation is shown above the individual graphs.

[Return to Figure 6.4]

Lab 07: Climate Change and Global Hurricane Tracking

Stuart MacKinnon

The climate is changing and the average global temperature of planet Earth is rising. Scientists have already noted that glaciers have shrunk, sea level has risen, ice on lakes and rivers have starting breaking up and melting earlier each year, there are more frequent and more intense heat waves, and plant and animal ranges have shifted. These effects are relatively easy to comprehend in the context of a rising global temperature, but what else does a changing climate entail? Of major concern are the various effects resulting from increased intensity of weather and climate events. Increasing intensity of precipitation events, along with increasing intensity of weather patterns and events, such as hurricanes, have already been observed. In your own life, you may have already noticed that summers seem hotter and dryer, that precipitation events seem more intense, or that local flooding events have been more common or more severe. These are all effects happening around us. The issues we face because of climate change will effect everyone, not just the polar bears and other inhabitants of the arctic who have seen the early effects of climate change more dramatically.

NASA has a good but short online article on The Effects of Climate Change (<https://climate.nasa.gov/effects/>) if you wish to read more about some of these effects. At the bottom of this NASA article you will also find references to some of the International Panel of Climate Change (IPCC) summaries, and assessments from the US National Climate Assessment. These are much more thorough technical reports, but do contain a wealth of information.

In this lab, you will explore what hurricanes are, how their intensity is measured, practice tracking a hurricane storm, and research a location prone to hurricane. You will demonstrate your understanding of hurricanes and climate change by creating a hurricane research report.

Learning Objectives

After completion of this lab, you will be able to

- Describe weather and climate impacts of climate change in simple language.
- Apply some effects of climate change to real world situations.
- Understand what hurricanes are, and how we measure their intensity.
- Track hurricane storms using hurricane tracking charts.
- Discuss how climate change is impacting hurricane storm systems.
- Consider climate change impact mitigation measures that you could personally implement.

Pre-Readings

What Causes Earth's Climate to Change Over Time?

Lab 06: Climate Analysis with Virtual Globes discusses what causes Earth's climate to change over time, and how scientists measure spatial variation in the Earth's energy budget. If you have completed Lab 06, it is recommended that you review this text as a refresher. If you have not completed lab 06, you should thoroughly review this text before proceeding with this lab.

What are Hurricanes and How Do We Measure Hurricane Intensity?

A hurricane is a type of tropical cyclone. A tropical cyclone is an organized system of clouds and thunderstorms that begin in tropical, or subtropical, waters. The winds of these systems blow in a circular manner, making the cyclone rotate. Winds blow quickly, and so their speeds are measured in kilometres per hour (km/h) or miles per hour (mph). In the Northern Hemisphere, tropical cyclones rotate counter-clockwise. In the Southern Hemisphere, tropical cyclones rotate clockwise. Tropical cyclones can be classified based on their sustained wind speeds:

- **Tropical Depression:** 61 km/hr (38 mph) or less maximum sustained wind speed
- **Tropical Storm:** 62 to 117 km/hr (39 to 73 mph) maximum sustained wind speed
- **Hurricane:** 118 km/hr (74 mph) or more maximum sustained wind speed
- **Major Hurricane:** 178 km/hr (111 mph) or more maximum sustained wind speed

Tropical Cyclone Climatology (<https://www.nhc.noaa.gov/climo/>) provides a good synopsis of what tropical cyclones are, the Atlantic and Eastern-Pacific climatology for the United States of America (USA), and some historical information on hurricanes that have occurred on and near the USA. Read the Tropical Cyclone Climatology (<https://www.nhc.noaa.gov/climo/>) online article to familiarize yourself with this information before proceeding with this lab.

Categories of hurricanes can be classified using the Saffir-Simpson Hurricane Wind Scale (<https://www.nhc.noaa.gov/aboutsshws.php>). Categories 1 and 2 correspond with the classification of hurricane above (118 to 177 km/hr maximum sustained wind speeds), and categories 3, 4, and 5 correspond with the classification of major hurricane above (178 km/hr or more maximum sustained wind speeds). These categories help to identify the hazard and anticipated damage that could result from the varying maximum sustained wind speed of different hurricanes. Review the Saffir-Simpson Hurricane Wind Scale (<https://www.nhc.noaa.gov/aboutsshws.php>) online article, and watch the **Hurricane Intensity Scale (Wind Damage)** animation on the same website before starting the lab exercises.

Lab Exercises

In these two lab exercises you will practice manually tracking a USA hurricane, then you will research and submit a hurricane research report. This hurricane research report will be based on a location of

your choice that is prone to hurricanes, and an examination of potential changes resulting from climate change. This lab should take 2-3 hours to complete.

EX1: Practice Tracking a US Hurricane

The National Hurricane Center (NHC) is a branch of the USA Government that monitors and tracks hurricane systems in both the Eastern Pacific and the Atlantic regions of the USA. In this exercise, you will manually track a current, or recent, hurricane system in one of these two regions. Your instructor will provide you with which hurricane system you are tracking, and they will guide you through how to complete the exercise. This exercise must be completed during class time, or at the time agreed with your instructor.

Step 1: Download either the **Eastern Pacific Blank Tracking Chart** or **Atlantic Blank Tracking Chart** from Worksheets. Your instructor will tell you which one you need. Then, print out a copy of this blank tracking chart prior to the lab/class time that you will be completing this exercise. If you are unable to print it out, you may be able to edit it using software such as Microsoft Photos or Paint. Check with your instructor first if electronic image editing is acceptable.

Step 2: Open the National Hurricane Center and Central Pacific Hurricane Center (<https://www.nhc.noaa.gov/>) (NHC) website. Your instructor will tell you where you need to navigate on this website to find the data you need.

Step 3: Using your pencils or the drawing tools in your software, mark the progress of the hurricane on your chart.

Step 4: Photograph or scan and upload (printed copies) and save to a known location on your computer (all versions). Submit as directed by your instructor.

EX2: Hurricane Research Report

Now, it is time for you to do your own research. In this exercise, you will research a current hurricane or historic hurricane that has occurred. This hurricane can be occurring, or have occurred, anywhere on the world; however, it must:

- have occurred since 1980,
- be/been classified as a hurricane, **not** a tropical storm, and
- have adequate information to write about all of the required research report components.

Research report components:

1. Introduction – one paragraph that includes the following information:
 - The name (if applicable) and classification of the hurricane (i.e., what was it?).
 - General geographic location of the hurricane (i.e., where was it?).

- When the hurricane occurred, and its duration (i.e., when was it?).
 - The reason you examined this hurricane (i.e., why did you choose it?).
2. Hurricane facts – 2 to 3 paragraphs that includes the following information:
- An explanation of the climatology that produced the hurricane.
 - What wind speeds were observed throughout the hurricane.
 - A description of the geographic path the hurricane travelled.
 - An account of the extent of damage caused by the hurricane (i.e., were houses and/or other human buildings destroyed? how many?).
 - If human buildings were destroyed, did they rebuild in the same location (if applicable).
 - Human impact mitigations that were in place because of hurricanes, or resulted because of the hurricane (if applicable).
 - Three other facts that you found interesting.
3. Conclusion – one **short** paragraph (2-3 sentences) that summarizes that key facts you want someone reading your report to remember.

Carefully read the research report components before selecting the hurricane you wish to research. If you have a hurricane in mind, check it against these requirements before continuing. If it does not meet the requirements, or you need some ideas, begin this exercise by doing an exploratory search on the internet for hurricane events. Finding an event that interests you will make writing about it easier.

Your instructor will provide you with guidelines on formatting, reference requirements, etc. Ensure you thoroughly review these before submitting your report as directed by your instructor.

Reflection Questions

1. How do you anticipate hurricane frequency and severity to change as a result of climate change? Why? Write 3-5 sentences to explain.
2. Many people associate climate change as something that only impacts the polar regions of the world. For example, the impact of melting sea ice on polar bears in the arctic. This is a misconception held by a large amount of people. There are actually some implications of climate change wherever anyone lives. Write 3-5 sentences outlining some climate change impacts within your community. You may need to start with a quick internet search for ideas.
3. What is one thing you could do to reduce your personal contribution to climate change? How will this personal change make a difference? Write 3-5 sentences to explain.

Worksheets

Return to EX1

Eastern Pacific Blank Tracking Chart

- Eastern Pacific Blank Tracking Chart [PDF] (https://pressbooks.bccampus.ca/geoglabmanualv2/wp-content/uploads/sites/1340/2021/08/tracking_chart_epacific.pdf)
- Eastern Pacific Blank Tracking Chart [PNG] (https://pressbooks.bccampus.ca/geoglabmanualv2/wp-content/uploads/sites/1340/2021/08/tracking_chart_epacific.png)
- Eastern Pacific Blank Tracking Chart [Word] (https://pressbooks.bccampus.ca/geoglabmanualv2/wp-content/uploads/sites/1340/2021/08/tracking_chart_epacific.docx)
- Eastern Pacific Blank Tracking Chart [ODT] (https://pressbooks.bccampus.ca/geoglabmanualv2/wp-content/uploads/sites/1340/2021/08/tracking_chart_epacific.odt)

Atlantic Blank Tracking Chart

- Atlantic Blank Tracking Chart [PDF] (https://pressbooks.bccampus.ca/geoglabmanualv2/wp-content/uploads/sites/1340/2021/08/tracking_chart_atlantic.pdf)
- Atlantic Blank Tracking Chart [PNG] (https://pressbooks.bccampus.ca/geoglabmanualv2/wp-content/uploads/sites/1340/2021/08/tracking_chart_atlantic.png)
- Atlantic Blank Tracking Chart [Word] (https://pressbooks.bccampus.ca/geoglabmanualv2/wp-content/uploads/sites/1340/2021/08/tracking_chart_atlantic.docx)
- Atlantic Blank Tracking Chart [ODT] (https://pressbooks.bccampus.ca/geoglabmanualv2/wp-content/uploads/sites/1340/2021/08/tracking_chart_atlantic.odt)

Source: NHC Blank Tracking Charts (https://www.nhc.noaa.gov/tracking_charts.shtml).

Lab 08: Atmospheric Moisture and Stability

Leonard Tang

Moisture in the atmosphere is an important component in understanding our atmosphere, as it allows us to understand the concept of humidity, how clouds and fog are formed, and when precipitation occurs. Atmospheric stability helps us to understand whether a parcel of air would sink, rise, or remain stationary, thereby determining whether clouds (and precipitation) form or not. Have you ever wondered why the climate is wetter on one side of a mountain than the other? Orographic lifting explains the effect mountains can have on precipitation patterns.

Learning Objectives

After completion of this lab, you will be able to

- Understand some of the most common variables used in atmospheric moisture.
- Learn the relationship between different moisture variables.
- Determine the stability of the atmosphere.
- Compute a problem associated with the orographic lifting process.

Pre-Readings

In order to complete this lab, some background information on moisture variables, atmospheric stability with respect to an air parcel, adiabatic processes, and orographic lifting are required.

Moisture Variables

A common method to determine the humidity in the atmosphere is to use an instrument called a sling psychrometer (Figure 8.1).

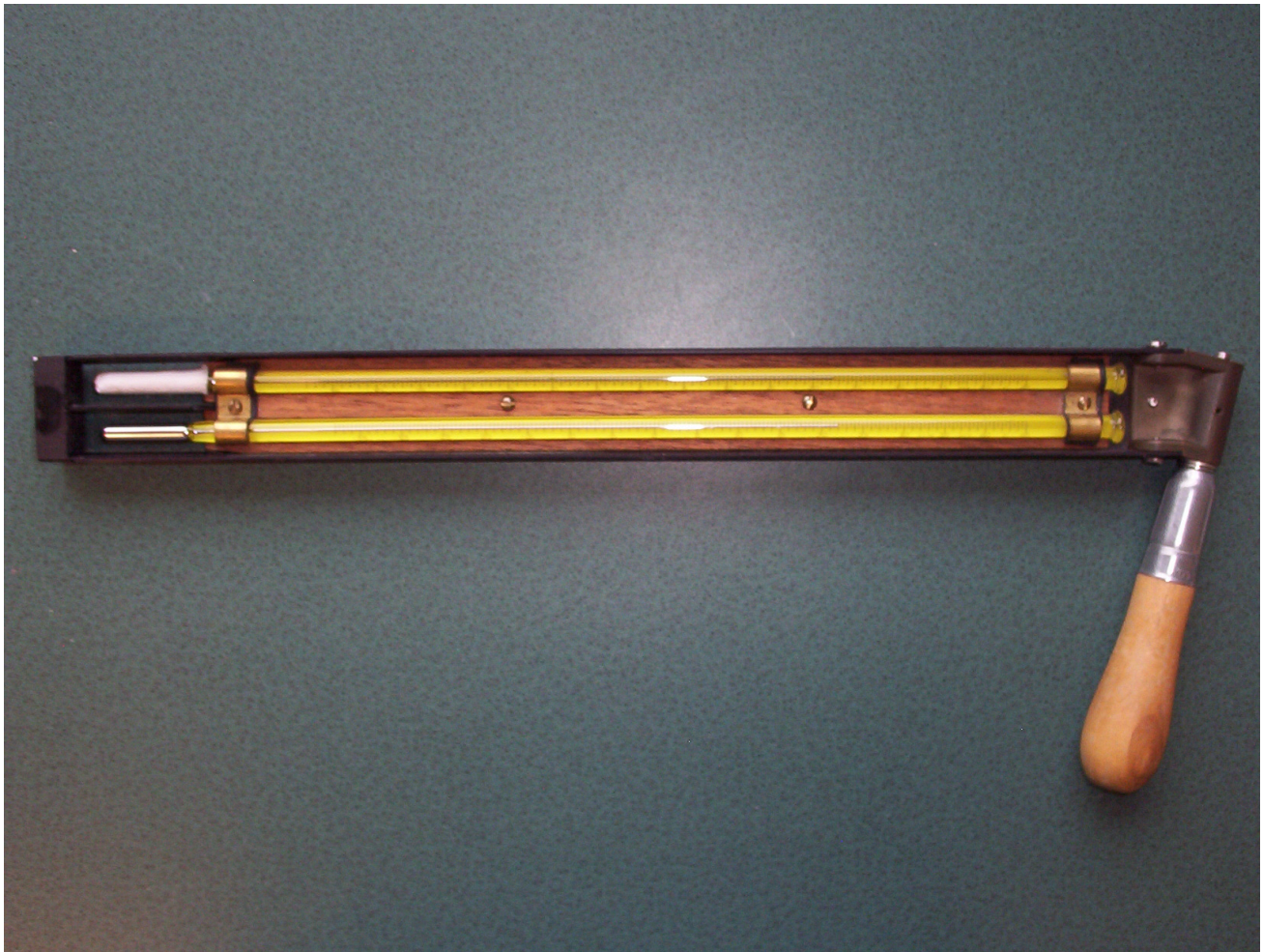


Figure 8.1. Sling psychrometer. Source: Cambridge Bay Weather (2005) (https://commons.wikimedia.org/wiki/File:Sling_psychrometer.JPG). Public Domain.

From the sling psychrometer, we can obtain two readings: the **dry-bulb temperature (T)** and **wet-bulb temperature (T_w)**. The difference between the dry-bulb and wet-bulb temperature is the **wet-bulb depression ($T - T_w$)**. This is expressed mathematically in Equation 8.1:

Equation 8.1

$$\text{Wet-bulb depression} = T - T_w (^{\circ}C).$$

We can then use a psychrometric table to determine the **relative humidity (RH)** of the air using the four-step procedure described here and illustrated in Figure 8.2:

Step 1: Calculate the wet-bulb depression. If $T = 20^{\circ}C$ and $T_w = 15^{\circ}C$, then using Equation 8.1,

$$T - T_w = 5^{\circ}C.$$

Step 2: Using the psychrometric table (Table 8.6), look down the first column until you locate the dry-bulb temperature ($T = 20^{\circ}C$).

Step 3: Still using the table, look across until you locate the wet-bulb depression calculated in Step 1.

Step 4: Trace lines across from T and down from T-T_w. The RH is found where these lines intersect. In this example, RH = 61.4%.

T (°C)	Wet bulb depression (T - T _w) (°C)																				
	0	0.5	1	1.5	2	2.5	3	3.5	4	4.5	5	5.5	6	6.5	7	7.5	8	8.5	9	9.5	10
-5	100%	90.0%	80.1%	70.4%	60.8%	51.3%	41.9%	32.7%	23.5%	14.5%	5.1%										
-4	100%	90.5%	81.1%	71.8%	62.7%	53.7%	44.8%	36.0%	27.3%	18.7%	10.3%	2.1%									
-3	100%	90.9%	82.0%	73.2%	64.5%	55.9%	47.4%	39.1%	30.8%	22.6%	14.3%	7.3%									
-2	100%	91.3%	82.8%	74.4%	66.1%	57.9%	49.8%	41.9%	34.0%	26.3%	18.3%	12.1%	4.3%								
-1	100%	91.7%	83.6%	75.5%	67.6%	59.8%	52.1%	44.5%	37.0%	29.6%	22.3%	16.5%	9.6%	1.3%							
0	100%	92.1%	84.3%	76.6%	69.0%	61.5%	54.2%	46.9%	39.8%	32.7%	25.3%	20.5%	14.4%	7.1%							
1	100%	92.4%	84.9%	77.6%	70.3%	63.2%	56.1%	49.2%	42.3%	35.6%	29.0%	24.2%	18.8%	12.3%	4.6%						
2	100%	92.7%	85.5%	78.5%	71.5%	64.7%	57.9%	51.3%	44.7%	38.3%	31.3%	27.7%	22.8%	17.0%	10.3%	2.2%					
3	100%	93.0%	86.1%	79.3%	72.6%	66.1%	59.6%	53.2%	46.9%	40.8%	34.7%	30.8%	26.4%	21.3%	15.4%	8.3%					
4	100%	93.3%	86.6%	80.1%	73.7%	67.4%	61.2%	55.0%	49.0%	43.1%	37.2%	33.7%	29.8%	25.2%	19.9%	13.7%	6.4%				
5	100%	93.5%	87.1%	80.8%	74.7%	68.6%	62.6%	56.7%	50.9%	45.2%	39.3%	36.4%	32.9%	28.8%	24.1%	18.6%	12.2%	4.5%			
6	100%	93.7%	87.6%	81.5%	75.6%	69.7%	64.0%	58.3%	52.7%	47.2%	41.3%	38.9%	35.7%	32.0%	27.8%	23.0%	17.4%	10.7%	2.8%		
7	100%	94.0%	88.0%	82.2%	76.4%	70.8%	65.2%	59.7%	54.4%	49.1%	43.3%	41.3%	38.3%	35.0%	31.3%	27.0%	22.0%	16.2%	9.3%	1.1%	
8	100%	94.2%	88.4%	82.8%	77.2%	71.8%	66.4%	61.1%	55.9%	50.8%	45.3%	43.4%	40.8%	37.8%	34.4%	30.6%	26.2%	21.1%	15.1%	8.1%	
9	100%	94.3%	88.8%	83.3%	77.9%	72.7%	67.5%	62.4%	57.4%	52.5%	47.3%	45.4%	43.0%	40.3%	37.2%	33.8%	29.9%	25.4%	20.2%	14.1%	6.9%
10	100%	94.5%	89.1%	83.8%	78.5%	73.5%	68.5%	63.6%	58.5%	54.0%	49.3%	47.3%	45.1%	42.6%	39.9%	36.8%	33.3%	29.3%	24.8%	19.5%	13.2%
11	100%	94.7%	89.5%	84.3%	79.3%	74.3%	69.5%	64.7%	60.0%	55.4%	50.3%	49.0%	47.0%	44.8%	42.3%	39.5%	36.4%	32.8%	28.8%	24.2%	18.8%
12	100%	94.8%	89.8%	84.8%	79.9%	75.1%	70.4%	65.8%	61.2%	56.7%	52.1%	50.7%	48.8%	46.8%	44.5%	42.0%	39.2%	36.0%	32.4%	28.4%	23.7%
13	100%	95.0%	90.1%	85.2%	80.5%	75.8%	71.2%	66.7%	62.3%	58.0%	53.7%	52.2%	50.5%	48.6%	46.6%	44.3%	41.7%	38.9%	35.7%	32.1%	28.0%
14	100%	95.1%	90.3%	85.6%	81.0%	76.5%	72.0%	67.7%	63.4%	59.2%	55.0%	53.6%	52.0%	50.3%	48.5%	46.4%	44.1%	41.5%	38.7%	35.5%	31.8%
15	100%	95.2%	90.6%	86.0%	81.5%	77.1%	72.8%	68.5%	64.4%	60.3%	56.3%	54.9%	53.5%	51.9%	50.2%	48.3%	46.2%	43.9%	41.4%	38.5%	35.3%
16	100%	95.4%	90.8%	86.4%	82.0%	77.7%	73.5%	69.4%	65.3%	61.3%	57.1%	56.2%	54.9%	53.4%	51.8%	50.1%	48.2%	46.1%	43.8%	41.3%	38.4%
17	100%	95.5%	91.0%	86.7%	82.4%	78.3%	74.2%	70.1%	66.2%	62.3%	58.5%	57.4%	56.1%	54.8%	53.4%	51.8%	50.1%	48.2%	46.1%	43.8%	41.2%
18	100%	95.6%	91.3%	87.0%	82.9%	78.8%	74.8%	70.9%	67.0%	63.2%	59.5%	58.5%	57.3%	56.1%	54.8%	53.3%	51.7%	50.0%	48.1%	46.0%	43.7%
19	100%	95.7%	91.5%	87.3%	83.3%	79.3%	75.4%	71.5%	67.8%	64.1%	60.5%	59.5%	58.4%	57.3%	56.1%	54.7%	53.3%	51.7%	50.0%	48.1%	46.0%
20	100%	95.8%	91.7%	87.6%	83.6%	79.7%	75.8%	72.0%	68.3%	64.6%	61.0%	60.0%	59.0%	58.0%	56.9%	55.5%	54.8%	53.3%	51.7%	50.0%	48.2%
21	100%	95.9%	91.8%	87.9%	84.0%	80.2%	76.5%	72.8%	69.2%	65.7%	62.1%	61.4%	60.5%	59.5%	58.5%	57.3%	56.1%	54.8%	53.4%	51.8%	50.1%
22	100%	96.0%	92.0%	88.1%	84.3%	80.6%	77.0%	73.4%	69.9%	66.4%	63.1%	62.3%	61.4%	60.5%	59.5%	58.5%	57.4%	56.2%	54.8%	53.4%	51.9%
23	100%	96.0%	92.2%	88.4%	84.7%	81.0%	77.4%	73.9%	70.5%	67.1%	63.8%	63.1%	62.3%	61.4%	60.5%	59.6%	58.5%	57.4%	56.2%	54.9%	53.5%
24	100%	96.1%	92.3%	88.6%	85.0%	81.4%	77.9%	74.5%	71.1%	67.8%	64.6%	63.9%	63.1%	62.3%	61.5%	60.6%	59.6%	58.6%	57.5%	56.3%	55.0%
25	100%	96.2%	92.5%	88.8%	85.2%	81.7%	78.3%	74.9%	71.6%	68.4%	65.2%	64.6%	63.9%	63.2%	62.4%	61.6%	60.7%	59.7%	58.7%	57.6%	56.4%
26	100%	96.3%	92.6%	89.0%	85.5%	82.1%	78.7%	75.4%	72.2%	69.0%	65.9%	65.3%	64.6%	64.0%	63.2%	62.5%	61.6%	60.7%	59.8%	58.8%	57.7%
27	100%	96.3%	92.7%	89.2%	85.8%	82.4%	79.1%	75.9%	72.7%	69.6%	66.5%	66.0%	65.3%	64.7%	64.0%	63.3%	62.5%	61.7%	60.8%	59.9%	58.9%
28	100%	96.4%	92.9%	89.4%	86.0%	82.7%	79.5%	76.3%	73.2%	70.1%	67.1%	66.6%	66.0%	65.4%	64.8%	64.1%	63.4%	62.6%	61.8%	60.9%	60.0%
29	100%	96.5%	93.0%	89.6%	86.3%	83.0%	79.8%	76.7%	73.6%	70.6%	67.7%	67.2%	66.6%	66.1%	65.5%	64.9%	64.2%	63.5%	62.7%	61.9%	61.0%
30	100%	96.5%	93.1%	89.8%	86.5%	83.3%	80.2%	77.1%	74.1%	71.1%	68.2%	67.7%	67.2%	66.7%	66.2%	65.6%	64.9%	64.3%	63.6%	62.8%	62.0%

Figure 8.2. How to use a psychrometric table: 1. Calculate the wet-bulb depression. 2. Locate the intersection of T and T-T_w. 3. This value is the RH value. Source: L. Tang, CC-BY-NC-SA 4.0.

We can also use Table 8.7 to help us determine other variables. For example, if T = 20°C, then Table 8.7 shows us that the **saturation vapour pressure (e_s)** is 2338 Pa.

Relative humidity can be calculated from vapour pressure using Equation 8.2:

Equation 8.2

$$RH(\%) = \frac{e (Pa)}{e_s (Pa)} \times 100\%$$

We can calculate the **actual vapour pressure (e)** by rearranging Equation 8.2:

$$e (Pa) = 2338 Pa \times \frac{61.4}{100} = 1436 Pa.$$

Now that we have e = 1436 Pa, we can obtain the **dew-point temperature (T_d)** from Table 8.7. By

inspection of the table, we can see that $e = 1436$ Pa is between the values 1402 Pa and 1498 Pa, and hence T_d is between 12°C and 13°C (specifically, 12.35°C by linear interpolation).

Atmospheric Stability

Concepts

Atmospheric stability helps determine whether clouds (and precipitation) form or not. The atmosphere could be

- stable, and so the air parcel remains stationary,
- unstable, and the air parcel either rises or sinks, or
- conditionally unstable.

A key to understanding atmospheric stability is the adiabatic process. An adiabatic process is one in which air is heated or cooled due to expansion or contraction but without addition or subtraction of heat. Air will heat or cool at the **dry adiabatic lapse rate (DALR = $10^\circ\text{C}/1000\text{m}$)** when the relative humidity is less than 100%. When the relative humidity is 100% (i.e. saturated air), air heats or cools at the **moist/saturated adiabatic lapse rate (MALR = $6^\circ\text{C}/1000\text{m}$ on average but varies between $5\text{-}9^\circ\text{C}/1000\text{m}$)**.

In Lab 03, you were introduced to the ideas of a sounding and the **Environmental Lapse Rate (ELR)**. The temperature data of the lower atmosphere is typically measured by a weather balloon. Twice a day, meteorologists release a weather balloon to measure temperatures at different elevations. The data are transmitted back to the ground where meteorologists can determine the stability.

To recap, the ELR is calculated using Equation 8.3:

Equation 8.3

$$ELR (\text{ }^\circ\text{C}/1000 \text{ m}) = -1000 \left(\frac{\Delta T (\text{ }^\circ\text{C})}{\Delta z (\text{m})} \right) = -1000 \left(\frac{T_2 - T_1}{z_2 - z_1} \right)$$

where

- Δ = delta symbol, represents the **change** in the variable it precedes (for example, the change in temperature)
- T = air temperature ($^\circ\text{C}$)
- z = altitude (m)
- T_1, z_1 = the measurement taken at the lower point in the atmosphere

Note that the ELR is also commonly presented with the units $^\circ\text{C}/1000\text{m}$ and so the equation differs slightly compared to the way it was presented in Lab 03.

To determine atmospheric stability, meteorologists compare the adiabatic lapse rate of an air parcel

(either DALR and/or MALR) with the environmental lapse rate (ELR). There are three possible conditions:

1. If $ELR > DALR > MALR$, there is absolute instability (unstable).
2. If $DALR > ELR > MALR$, there is conditional instability (conditionally unstable).
3. If $DALR > MALR > ELR$, there is absolute stability (stable).

Finally, as dry air parcels rise, they cool at the DALR until the dew-point temperature is reached. The elevation at which the dew-point is reached is the **Lifting Condensation Level (LCL)**. The LCL can be calculated using Equation 8.4:

Equation 8.4

$$LCL (m) = \frac{T(^{\circ}C) - T_d(^{\circ}C)}{DALR (^{\circ}C/1000 m)}$$

where T is the temperature of the air parcel and T_d is the dew-point temperature of the air parcel at the surface, both in $^{\circ}C$.

The final calculation that we may wish to do is to calculate temperature at a specific altitude with a known lapse rate, and known change in altitude. The **temperature at a specific altitude (T_z)** can be calculated using Equation 8.5:

Equation 8.5

$$T_z (^{\circ}C) = T_{Initial} (^{\circ}C) \pm \left[|\Delta z(m)| \times \text{Lapse Rate } (^{\circ}C/1000 m) \right]$$

The lapse rate may be the DALR or MALR as appropriate. Add (+) to $T_{Initial}$ when T_z is at a lower altitude than $T_{Initial}$, and subtract from $T_{Initial}$ when T_z is at a higher altitude.

Application

Let us put all these concepts together with an example. Assume that the data transmitted by a weather balloon are presented in Table 8.1. We can then use the following seven-step process to visualize what will happen to an air parcel as it rises through the atmosphere.

Table 8.1. Data from an imaginary atmospheric sounding.

Altitude (m)	Temperature (°C)
0	25.0
200	22.8
450	20.0
600	18.4
800	16.6
1050	14.4
1200	13.1
1400	12.1
1550	11.3
1800	9.9
2000	8.8

Step 1: Transfer the data onto the Atmospheric Stability Analysis Form.

Step 2: For each layer of the atmosphere, determine the **change in altitude (Δz)** and **change in temperature (ΔT)**. For example, layer 1 is between 0 m (z_1) and 200 m (z_2), and so:

$$\Delta z = 200m - 0m = 200m$$

$$\Delta T = 22.8^\circ C - 25.0^\circ C = -2.2^\circ C.$$

Values for all layers are presented in Table 8.2.

Table 8.2. Partially completed Atmospheric Stability Analysis Form with changes in altitude and temperature recorded. Source: L. Tang, CC BY-NC-SA 4.0.

Layer	Altitude (m)	Temp. (°C)	Δz (m)	ΔT (°C)	ELR (°C/1000 m)	Stability
	0	25.0				
1			200	-2.2		
	200	22.8				
2			150	-2.8		
	450	20.0				
3			150	-1.6		
	600	18.4				
4			200	-1.8		
	800	16.6				
5			250	-2.2		
	1050	14.4				
6			150	-1.3		
	1200	13.1				
7			200	-1.0		
	1400	12.1				
8			150	-0.8		
	1550	11.3				
9			250	-1.4		
	1800	9.9				
10			200	-1.1		
	2000	8.8				

Step 3: Determine the ELR of all layers of the atmosphere using Equation 8.3. For example, for layer 1,

$$ELR (\text{°C}/1000 \text{ m}) = -1000 \left(\frac{\Delta T (\text{°C})}{\Delta z (\text{m})} \right) = -1000 \left(\frac{-2.2 \text{°C}}{200 \text{m}} \right) = 11.0 \text{°C}/1000 \text{ m}.$$

Values for all layers are presented in Table 8.3.

Table 8.3. Partially completed Atmospheric Stability Analysis Form with ELRs recorded. Source: L. Tang, CC BY-NC-SA 4.0.

Layer	Altitude (m)	Temp. (°C)	Δ Alt. (m)	Δ Temp. (°C)	ELR (°C/1000 m)	Stability
	0	25.0				
1			200	-2.2	11.0	
	200	22.8				
2			150	-2.8	11.2	
	450	20.0				
3			150	-1.6	10.7	
	600	18.4				
4			200	-1.8	9.0	
	800	16.6				
5			250	-2.2	8.8	
	1050	14.4				
6			150	-1.3	8.7	
	1200	13.1				
7			200	-1.0	5.0	
	1400	12.1				
8			150	-0.8	5.3	
	1550	11.3				
9			250	-1.4	5.6	
	1800	9.9				
10			200	-1.1	5.5	
	2000	8.8				

Step 4: Determine the stability of all layers of the atmosphere by comparing the values of the ELR to the DALR and MALR. For example, for layer 1, the ELR is 11.0°C, which is greater than both the DALR and the MALR. The layer is therefore unstable. Values for all layers are presented in Table 8.4.

Table 8.4. Completed Atmospheric Stability Analysis Form with stability conditions recorded. Source: L. Tang, CC BY-NC-SA 4.0.

Layer	Altitude (m)	Temp. (°C)	Δ Alt. (m)	Δ Temp. (°C)	ELR (°C/1000 m)	Stability
	0	25.0				
1			200	-2.2	11.0	unstable
	200	22.8				
2			150	-2.8	11.2	unstable
	450	20.0				
3			150	-1.6	10.7	unstable
	600	18.4				
4			200	-1.8	9.0	conditionally unstable
	800	16.6				
5			250	-2.2	8.8	conditionally unstable
	1050	14.4				
6			150	-1.3	8.7	conditionally unstable
	1200	13.1				
7			200	-1.0	5.0	stable
	1400	12.1				
8			150	-0.8	5.3	stable
	1550	11.3				
9			250	-1.4	5.6	stable
	1800	9.9				
10			200	-1.1	5.5	stable
	2000	8.8				

Step 5: Once the Atmospheric Stability Analysis Form is completed, we can plot an atmospheric sounding similar to the one you did in Lab 03. This will help us analyze what could happen to an air parcel. First, plot the temperature data as a line with markers (Figure 8.3).

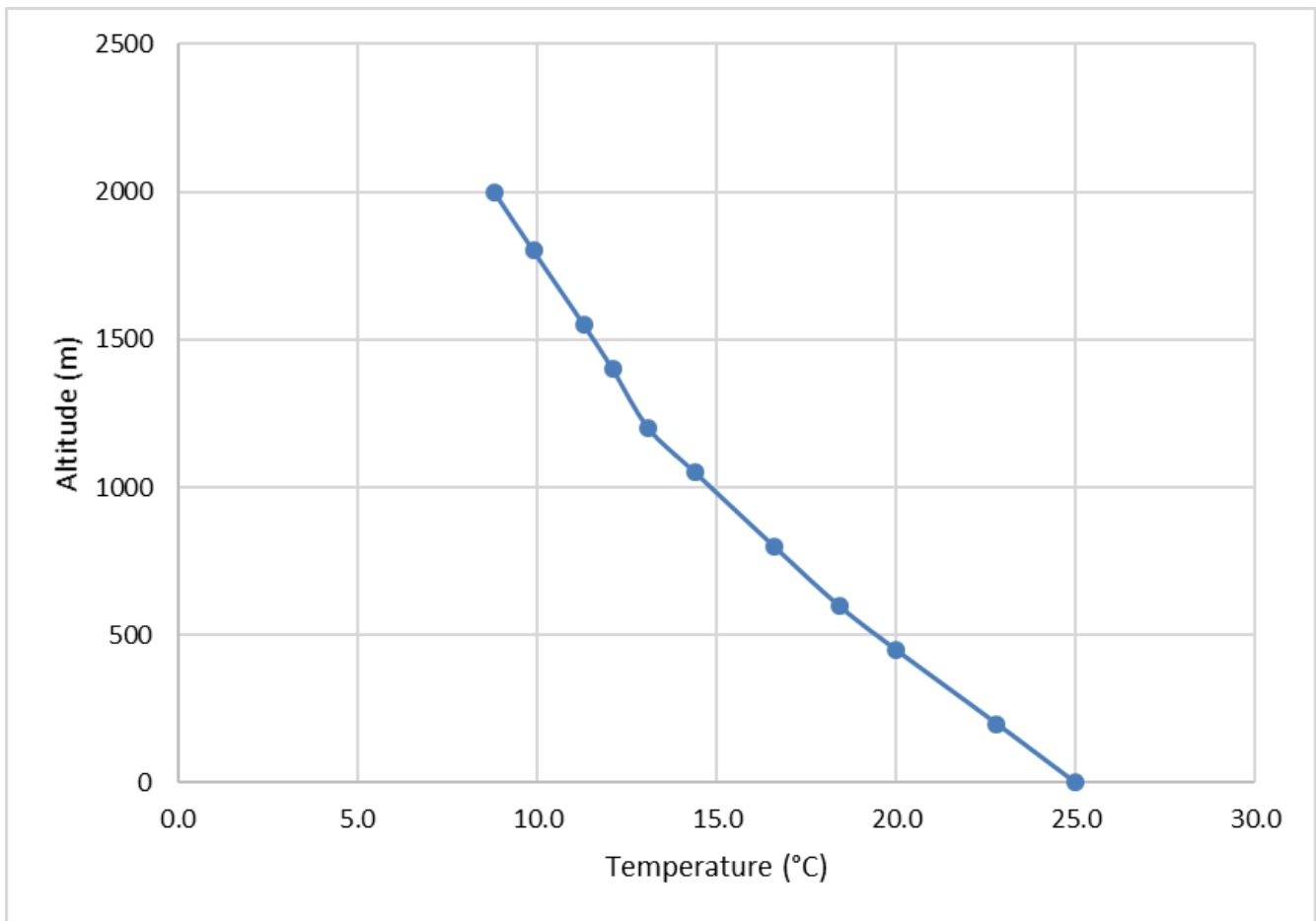


Figure 8.3. Atmospheric sounding line plotted from data in Table 8.3. Source: L. Tang, CC BY-NC-SA 4.0.

Step 6: Calculate the change in temperature of an imaginary air parcel as it rises from the ground to 2000 m elevation.

- First up, we need to decide if the air parcel is saturated or not (i.e., $RH > 100\%$ or $RH < 100\%$). The air parcel has a temperature (T) of 22°C and dew-point temperature (T_d) of 16°C at the surface. Because T is greater than T_d , we know that the air parcel is not saturated with water vapour (i.e. $RH < 100\%$). It will therefore cool at the DALR as it rises until the dew-point temperature is reached.
- So, we need to calculate the LCL using Equation 8.4 for this air parcel to determine the altitude at which the dew-point temperature is reached. In this example,

$$LCL (m) = \frac{T(^{\circ}C) - T_d(^{\circ}C)}{DALR (^{\circ}C/1000 m)}$$

$$LCL (m) = \frac{22^{\circ}C - 16^{\circ}C}{10^{\circ}C/1000 m}$$

$$LCL (m) = \frac{6^{\circ}C}{10^{\circ}C/1000 m}$$

$$LCL (m) = 6^{\circ}C \left(\frac{1000 m}{10^{\circ}C} \right)$$

$$LCL (m) = 600 m.$$

- c. Once the air parcel reaches its LCL, the rate of cooling slows to the MALR, and so we now need to calculate the temperature of the air parcel at 2000 m (T_z) using the MALR and Equation 8.5. In this example, $T_{Initial} = T_d = 16^{\circ}C$, and $z_1 = LCL = 600 m$:

$$T_z (^{\circ}C) = T_{Initial} (^{\circ}C) \pm \left[|\Delta z(m)| \times \text{Lapse Rate } (^{\circ}C/1000 m) \right]$$

$$T_{z=2000m} (^{\circ}C) = 16^{\circ}C - \left[|600m - 2000m| \times \frac{6^{\circ}C}{1000m} \right]$$

$$T_{z=2000m} (^{\circ}C) = 16^{\circ}C - \left[1400m \times \frac{6^{\circ}C}{1000m} \right]$$

$$T_{z=2000m} (^{\circ}C) = 16^{\circ}C - 8.4^{\circ}C$$

$$T_{z=2000m} (^{\circ}C) = 7.6^{\circ}C$$

Step 7: Plot the change in temperature of this air parcel and the LCL on the atmospheric sounding. Select a different colour and/or different line marker or style for each line. Label each component of the plot. The result is shown on Figure 8.4.

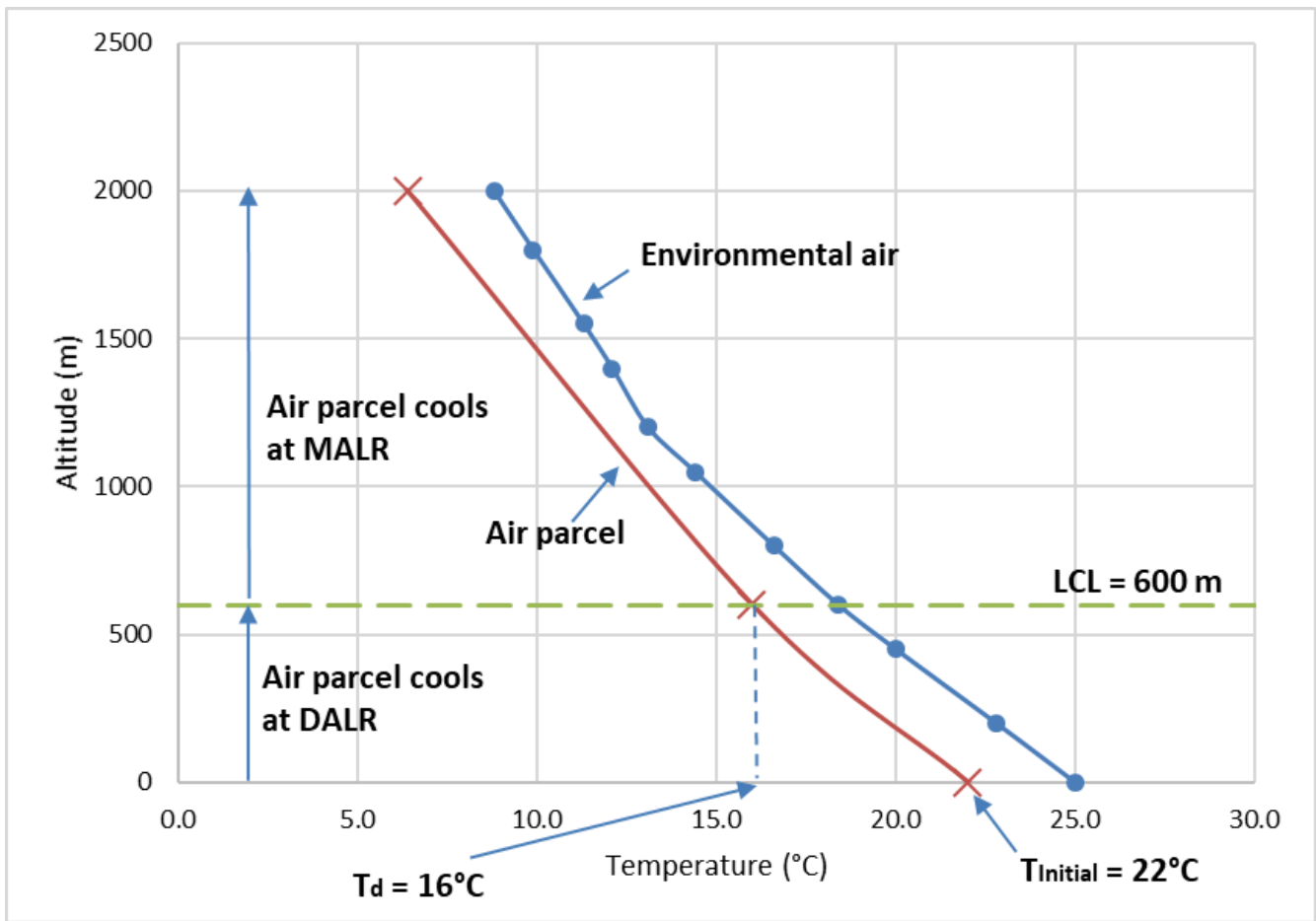


Figure 8.4. Changing temperature of a rising parcel of air. The temperature of the ambient atmosphere (Environmental air) is shown with a blue line with dots. The temperature of the rising parcel of air is shown with a red line with crosses. The LCL is shown with a dashed green line. Source: L. Tang, CC BY-NC-SA 4.0.

Orographic Lifting

An orographic lifting process is where an air parcel is forced to go over a geographic barrier such as a mountain. When the air parcel ascends on the sea side of the mountain (blue arrows), air cools adiabatically until it reaches the Lifting Condensation Level (LCL). Consequently, air becomes saturated and water vapour condenses to form clouds. As air descends on the leeward side of the mountain (red arrows with hatching), it warms adiabatically at the DALR. Figure 8.5 illustrates this concept.

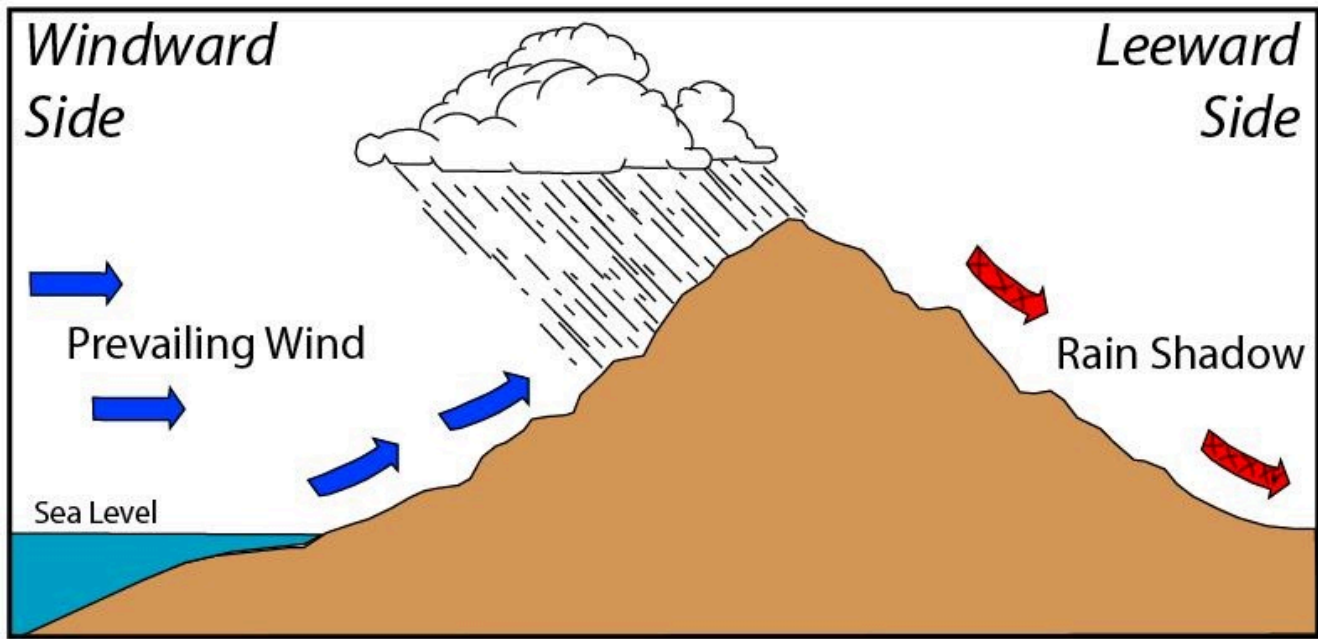


Figure 8.5. Schematic diagram illustrating the orographic effect. Source: M. Stewart (2013), CC BY-SA, adapted by C. Welch.

We can use the relationships presented above to calculate the the change in temperature of an air parcel as it moves through the orographic process. For example, assume an air parcel at sea-level has temperature of 20°C and dew-point temperature of 15°C . This air parcel is forced to rise over a mountain that is 2000 m high and descend back to sea-level on the other side of the mountain (leeward side).

Step 1: Determine the LCL using Equation 8.4:

$$LCL (m) = \frac{T(^{\circ}\text{C}) - T_d(^{\circ}\text{C})}{DALR (^{\circ}\text{C}/1000\text{ m})} = \frac{20^{\circ}\text{C} - 15^{\circ}\text{C}}{10^{\circ}\text{C}/1000\text{ m}} = 500\text{ m}$$

Step 2: Determine the temperature of the air parcel when it reaches the summit using Equation 8.5:

$$T_z (^{\circ}\text{C}) = T_{Initial} (^{\circ}\text{C}) - \left[|\Delta z(m)| \times MALR (^{\circ}\text{C}/1000\text{ m}) \right]$$

$$T_{z=2000m} (^{\circ}\text{C}) = 15^{\circ}\text{C} - \left[|500\text{m} - 2000\text{m}| \times \frac{6^{\circ}\text{C}}{1000\text{m}} \right] = 6^{\circ}\text{C}$$

Step 3: Determine the temperature of the air parcel when it sinks back to sea-level on the other side of the mountain (leeward side) using Equation 8.5:

$$T_z (^{\circ}\text{C}) = T_{Initial} (^{\circ}\text{C}) + \left[|\Delta z(m)| \times DALR (^{\circ}\text{C}/1000\text{ m}) \right]$$

$$T_{z=0m} = 6^{\circ}C + \left[|2000m - 0m| \times \frac{10^{\circ}C}{1000m} \right] = 26^{\circ}C$$

Lab Exercises

In this lab, you will be doing a number of different calculations to help you understand the concepts of atmospheric moisture and stability. You will:

- Convert between moisture variables and related temperatures.
- Relate atmospheric moisture to your own comfort level.
- Analyze atmospheric stability and visually present the information you calculate.

A calculator is required, and you will also be plotting a graph—your instructor will decide if you will use a graph paper or a spreadsheet. Please make sure to show all your calculations (to maximize partial credits) and not just the answers. It is estimated that this lab will take 4-5 hours to complete.

EX1: Moisture Variables

1. Complete Table 8.5. It is also available for download in Worksheets. **Give answers for RH and T_d to one decimal place, and e to the nearest integer.**

Use Table 8.6 and Table 8.7 in the Supporting Material section. Show your calculations on a separate page.

Table 8.5. Conversions between moisture variables.

	Dry-bulb temperature (T)	Wet-bulb temperature (Tw)	Wet-bulb depression (T-Tw)	Relative humidity (RH)	Saturation vapour pressure (es)	Actual vapour pressure (e)	Dew-point temperature (Td)
a)	13°C	11°C					
b)	15°C		6°C				
c)	28°C			70.1%			
d)	20°C	N/A	N/A				13.0°C
e)	5°C					705 Pa	
f)					3779 Pa	2267 Pa	
g)	24°C						24.0°C

EX2: Atmospheric Moisture

2. On a cold snowy day, the outside air temperature is 0°C and the relative humidity is 100%. The air is taken into the house and heated to 21°C . What is the relative humidity inside the house?
3. Dew is often formed on grass early in the morning but not at other times of the day. Explain why this is.
4. Go to Historical Data Report for Vancouver International Airport (https://climate.weather.gc.ca/climate_data/hourly_data_e.html?hlyRange=2013-06-11%7C2021-07-21&dlyRange=2013-06-13%7C2021-07-21&mlyRange=%7C&StationID=51442&Prov=BC&urlExtension=_e.html&searchType=stnName&optLimit=yearRange&StartYear=1840&EndYear=2021&selRowPerPage=25&Line=39&searchMethod=contains&Month=7&Day=21&txtStationName=vancouver&timeframe=1&Year=2021). Check that the date matches today's date. Have a look at the relative humidity. Next, click the Previous Day button located to the left of the date bar, and track the relative humidity over the preceding 3-4 days. Think back to how you felt over those days. Do you feel more comfortable when the RH is high, or low? Explain the major factors that affect RH.
5. Search online to acquire the company names and model numbers of at least two different instruments (other than the sling psychrometer) for sensing humidity.

EX3: Atmospheric Stability

6. A meteorological balloon is sent aloft and temperature data are obtained. Your instructor will provide you with this data, or instructions on how to obtain it.
 - a. Open the Atmospheric Stability Analysis Form in Worksheets and enter the temperature and altitude data.
 - b. Plot the vertical temperature profile (sounding) using Excel. If required, step-by-step instructions on how to do this are provided in Lab 03 EX1 Step 4.
 - c. Label this line **Environmental Air**.
 - d. Label the axes of your graph. Include units.
7. Complete the Atmospheric Stability Analysis Form. Give your answers for ELR to one decimal place. Assume a DALR of $10^{\circ}\text{C} / \text{km}$ and an MALR of $6^{\circ}\text{C} / \text{km}$.
8. An air parcel of 24°C and dew-point temperature of 16°C is currently hovering at the surface. The air parcel is forced to rise up to an altitude of 2000 m.
 - a. Calculate the lifting condensation level (LCL). Add the LCL to your graph.
 - b. Plot a line showing the hypothetical change in temperature of this rising parcel on your graph.

- c. Label this line **Air Parcel**. On the line indicate where the rising parcel of air cools at the DALR and where it cools at the MALR.

Submit the Atmospheric Stability Analysis Form and your graph as directed by your instructor.

EX4: Orographic Process

Air blowing off the Pacific Ocean has a temperature of 15°C and a dew-point temperature of 10°C at Vancouver (sea level). This air is forced to rise over the Coast Range on its way to Calgary.

9. What is the LCL of the air blowing off the Pacific Ocean at Vancouver?
10. What is the temperature of the air parcel at the top of the Coast Range ($z = 2200\text{ m}$)?
11. What is the temperature of the air parcel in Calgary ($z = 1200\text{ m}$)?

Show your calculations.

Reflection Questions

1. If we changed the temperature of the air parcel in Vancouver to 30°C and dew-point temperature to 7°C in EX4, what would the temperature of the air parcel be when it reaches Calgary? Explain what will happen in 2-3 sentences.
2. Condensation, as occurs at the LCL, is one example of phase change. Take a picture of something around you that illustrates one of the processes of phase change. Take the photo at home or somewhere outside. Include one or two sentences to describe what that example is. Do not use a scenario that has already been discussed in class.
3. Draw a line on the picture in Figure 8.5 indicating where the Lifting Condensation Level (LCL) is. Explain your reasoning in 2-3 sentences.



Figure 8.5. View from downtown Vancouver over the harbour. Cumulus clouds are rising from the snow-covered mountains in the distance. Source: L. Tang, CC BY-NC-SA 4.0.

Worksheets

EX1 Worksheet – Table 8.5

- Table 8.5 EX1 Worksheet [Word] (<https://pressbooks.bccampus.ca/geoglabmanualv2/wp-content/uploads/sites/1340/2020/07/Lab-08-Table-8.5.docx>)
- Table 8.5 EX1 Worksheet [ODT] (<https://pressbooks.bccampus.ca/geoglabmanualv2/wp-content/uploads/sites/1340/2020/07/Lab-08-Table-8.5.odt>)
- Table 8.5 EX1 Worksheet [PDF] (<https://pressbooks.bccampus.ca/geoglabmanualv2/wp-content/uploads/sites/1340/2020/07/Lab-08-Table-8.5.pdf>)

Atmospheric Stability Analysis Form

- Lab 08 Atmospheric Stability Analysis Form [Word] (<https://pressbooks.bccampus.ca/geoglabmanualv2/wp-content/uploads/sites/1340/2020/07/Lab-08-Atmospheric-Stability->

Analysis-Form.docx)

- Lab 08 Atmospheric Stability Analysis Form [Excel] (<https://pressbooks.bccampus.ca/geoglabmanualv2/wp-content/uploads/sites/1340/2020/07/Lab-08-Atmospheric-Stability-Analysis-Form.xlsx>)
- Lab 08 Atmospheric Stability Analysis Form [ODT] (<https://pressbooks.bccampus.ca/geoglabmanualv2/wp-content/uploads/sites/1340/2020/07/Lab-08-Atmospheric-Stability-Analysis-Form.odt>)
- Lab 08 Atmospheric Stability Analysis Form [PDF] (<https://pressbooks.bccampus.ca/geoglabmanualv2/wp-content/uploads/sites/1340/2020/07/Lab-08-Atmospheric-Stability-Analysis-Form.pdf>)

Supporting Material

Back to top

T (°C)	Wet bulb depression (T - T _w) (°C)																				
	0	0.5	1	1.5	2	2.5	3	3.5	4	4.5	5	5.5	6	6.5	7	7.5	8	8.5	9	9.5	10
-5	100%	90.0%	80.1%	70.4%	60.8%	51.3%	41.9%	32.7%	23.5%	14.5%	5.6%										
-4	100%	90.5%	81.1%	71.8%	62.7%	53.7%	44.8%	36.0%	27.3%	18.7%	10.3%	2.1%									
-3	100%	90.9%	82.0%	73.2%	64.5%	55.9%	47.4%	39.1%	30.8%	22.6%	14.6%	7.3%									
-2	100%	91.3%	82.8%	74.4%	66.1%	57.9%	49.8%	41.9%	34.0%	26.3%	18.6%	12.1%	4.3%								
-1	100%	91.7%	83.6%	75.5%	67.6%	59.8%	52.1%	44.5%	37.0%	29.6%	22.3%	16.5%	9.6%	1.3%							
0	100%	92.1%	84.3%	76.6%	69.0%	61.5%	54.2%	46.9%	39.8%	32.7%	25.8%	20.5%	14.4%	7.1%							
1	100%	92.4%	84.9%	77.6%	70.3%	63.2%	56.1%	49.2%	42.3%	35.6%	29.0%	24.2%	18.8%	12.3%	4.6%						
2	100%	92.7%	85.5%	78.5%	71.5%	64.7%	57.9%	51.3%	44.7%	38.3%	31.9%	27.7%	22.8%	17.0%	10.3%	2.2%					
3	100%	93.0%	86.1%	79.3%	72.6%	66.1%	59.6%	53.2%	46.9%	40.8%	34.7%	30.8%	26.4%	21.3%	15.4%	8.3%					
4	100%	93.3%	86.6%	80.1%	73.7%	67.4%	61.2%	55.0%	49.0%	43.1%	37.2%	33.7%	29.8%	25.2%	19.9%	13.7%	6.4%				
5	100%	93.5%	87.1%	80.8%	74.7%	68.6%	62.6%	56.7%	50.9%	45.2%	39.6%	36.4%	32.9%	28.8%	24.1%	18.6%	12.2%	4.5%			
6	100%	93.7%	87.6%	81.5%	75.6%	69.7%	64.0%	58.3%	52.7%	47.2%	41.8%	38.9%	35.7%	32.0%	27.8%	23.0%	17.4%	10.7%	2.8%		
7	100%	94.0%	88.0%	82.2%	76.4%	70.8%	65.2%	59.7%	54.4%	49.1%	43.9%	41.3%	38.3%	35.0%	31.3%	27.0%	22.0%	16.2%	9.3%	1.1%	
8	100%	94.2%	88.4%	82.8%	77.2%	71.8%	66.4%	61.1%	55.9%	50.8%	45.8%	43.4%	40.8%	37.8%	34.4%	30.6%	26.2%	21.1%	15.1%	8.1%	
9	100%	94.3%	88.8%	83.3%	77.9%	72.7%	67.5%	62.4%	57.4%	52.5%	47.6%	45.4%	43.0%	40.3%	37.2%	33.8%	29.9%	25.4%	20.2%	14.1%	6.9%
10	100%	94.5%	89.1%	83.8%	78.6%	73.5%	68.5%	63.6%	58.7%	54.0%	49.3%	47.3%	45.1%	42.6%	39.9%	36.8%	33.3%	29.3%	24.8%	19.5%	13.2%
11	100%	94.7%	89.5%	84.3%	79.3%	74.3%	69.5%	64.7%	60.0%	55.4%	50.9%	49.0%	47.0%	44.8%	42.3%	39.5%	36.4%	32.8%	28.8%	24.2%	18.8%
12	100%	94.8%	89.8%	84.8%	79.9%	75.1%	70.4%	65.8%	61.2%	56.7%	52.4%	50.7%	48.8%	46.8%	44.5%	42.0%	39.2%	36.0%	32.4%	28.4%	23.7%
13	100%	95.0%	90.1%	85.2%	80.5%	75.8%	71.2%	66.7%	62.3%	58.0%	53.7%	52.2%	50.5%	48.6%	46.6%	44.3%	41.7%	38.9%	35.7%	32.1%	28.0%
14	100%	95.1%	90.3%	85.6%	81.0%	76.5%	72.0%	67.7%	63.4%	59.2%	55.0%	53.6%	52.0%	50.3%	48.5%	46.4%	44.1%	41.5%	38.7%	35.5%	31.8%
15	100%	95.2%	90.6%	86.0%	81.5%	77.1%	72.8%	68.5%	64.4%	60.3%	56.3%	54.9%	53.5%	51.9%	50.2%	48.3%	46.2%	43.9%	41.4%	38.5%	35.3%
16	100%	95.4%	90.8%	86.4%	82.0%	77.7%	73.5%	69.4%	65.3%	61.3%	57.4%	56.2%	54.9%	53.4%	51.8%	50.1%	48.2%	46.1%	43.8%	41.3%	38.4%
17	100%	95.5%	91.0%	86.7%	82.4%	78.3%	74.2%	70.1%	66.2%	62.3%	58.5%	57.4%	56.1%	54.8%	53.4%	51.8%	50.1%	48.2%	46.1%	43.8%	41.2%
18	100%	95.6%	91.3%	87.0%	82.9%	78.8%	74.8%	70.9%	67.0%	63.2%	59.5%	58.5%	57.3%	56.1%	54.8%	53.3%	51.7%	50.0%	48.1%	46.0%	43.7%
19	100%	95.7%	91.5%	87.3%	83.3%	79.3%	75.4%	71.5%	67.8%	64.1%	60.5%	59.5%	58.4%	57.3%	56.1%	54.7%	53.3%	51.7%	50.0%	48.1%	46.0%
20	100%	95.8%	91.7%	87.6%	83.6%	79.7%	75.9%	72.2%	68.5%	64.9%	61.4%	60.5%	59.5%	58.4%	57.3%	56.1%	54.8%	53.3%	51.7%	50.0%	48.2%
21	100%	95.9%	91.8%	87.9%	84.0%	80.2%	76.5%	72.8%	69.2%	65.7%	62.2%	61.4%	60.5%	59.5%	58.5%	57.3%	56.1%	54.8%	53.4%	51.8%	50.1%
22	100%	96.0%	92.0%	88.1%	84.3%	80.6%	77.0%	73.4%	69.9%	66.4%	63.1%	62.3%	61.4%	60.5%	59.5%	58.5%	57.4%	56.2%	54.8%	53.4%	51.9%
23	100%	96.0%	92.2%	88.4%	84.7%	81.0%	77.4%	73.9%	70.5%	67.1%	63.8%	63.1%	62.3%	61.4%	60.5%	59.6%	58.5%	57.4%	56.2%	54.9%	53.5%
24	100%	96.1%	92.3%	88.6%	85.0%	81.4%	77.9%	74.5%	71.1%	67.8%	64.6%	63.9%	63.1%	62.3%	61.5%	60.6%	59.6%	58.6%	57.5%	56.3%	55.0%
25	100%	96.2%	92.5%	88.8%	85.2%	81.7%	78.3%	74.9%	71.6%	68.4%	65.2%	64.6%	63.9%	63.2%	62.4%	61.6%	60.7%	59.7%	58.7%	57.6%	56.4%
26	100%	96.3%	92.6%	89.0%	85.5%	82.1%	78.7%	75.4%	72.2%	69.0%	65.9%	65.3%	64.6%	64.0%	63.2%	62.5%	61.6%	60.7%	59.8%	58.8%	57.7%
27	100%	96.3%	92.7%	89.2%	85.8%	82.4%	79.1%	75.9%	72.7%	69.6%	66.5%	66.0%	65.3%	64.7%	64.0%	63.3%	62.5%	61.7%	60.8%	59.9%	58.9%
28	100%	96.4%	92.9%	89.4%	86.0%	82.7%	79.5%	76.3%	73.2%	70.1%	67.1%	66.6%	66.0%	65.4%	64.8%	64.1%	63.4%	62.6%	61.8%	60.9%	60.0%
29	100%	96.5%	93.0%	89.6%	86.3%	83.0%	79.8%	76.7%	73.6%	70.6%	67.7%	67.2%	66.6%	66.1%	65.5%	64.9%	64.2%	63.5%	62.7%	61.9%	61.0%
30	100%	96.5%	93.1%	89.8%	86.5%	83.3%	80.2%	77.1%	74.1%	71.1%	68.2%	67.7%	67.2%	66.7%	66.2%	65.6%	64.9%	64.3%	63.6%	62.8%	62.0%

Table 8.6. Psychrometric table for use with sling psychrometer. Wet bulb depression (T – T_w) is in °C. Source: L. Tang, CC BY-NC-SA 4.0.

Table 8.7. Saturation humidity vs actual air temperature or actual humidity vs dew-point temperature. T = dry-bulb temperature; T_d = dew-point temperature; e = actual vapour pressure; e_s = saturation vapour pressure; q = specific humidity; q_s = saturated specific humidity. Source: L. Tang, CC BY-NC-SA 4.0.

T or T _d (°C)	e _s or e (Pa)	q _s or q (g/kg)	T or T _d (°C)	e _s or e (Pa)	q _s or q (g/kg)
-40	18	0.11	0	611	3.76
-39	20	0.12	1	657	4.04
-38	23	0.14	2	706	4.35
-37	25	0.15	3	758	4.67
-36	28	0.17	4	813	5.01
-35	31	0.19	5	872	5.37
-34	34	0.21	6	935	5.76
-33	38	0.23	7	1002	6.18
-32	41	0.25	8	1073	6.61
-31	46	0.28	9	1148	7.08
-30	50	0.31	10	1228	7.57
-29	55	0.34	11	1313	8.10
-28	61	0.37	12	1402	8.65
-27	67	0.41	13	1498	9.25
-26	73	0.45	14	1598	9.87
-25	80	0.49	15	1705	10.54
-24	88	0.54	16	1818	11.24
-23	96	0.59	17	1938	11.99
-22	105	0.64	18	2064	12.77
-21	114	0.70	19	2197	13.60
-20	125	0.77	20	2338	14.48
-19	136	0.84	21	2487	15.41
-18	148	0.91	22	2644	16.40
-17	161	0.99	23	2809	17.43
-16	175	1.08	24	2984	18.53
-15	190	1.17	25	3167	19.68
-14	207	1.27	26	3361	20.90

-13	224	1.38	27	3565	22.18
-12	243	1.49	28	3779	23.54
-11	264	1.62	29	4005	24.96
-10	286	1.76	30	4242	26.47
-9	309	1.90	31	4492	28.05
-8	334	2.05	32	4754	29.72
-7	361	2.22	33	5029	31.47
-6	390	2.40	34	5318	33.31
-5	421	2.59	35	5622	35.26
-4	454	2.79	36	5940	37.30
-3	490	3.01	37	6274	39.45
-2	527	3.24	38	6624	41.70
-1	568	3.50	39	6990	44.07
0	611	3.76	40	7374	46.56

Figure 8.6. Psychrometric Graph

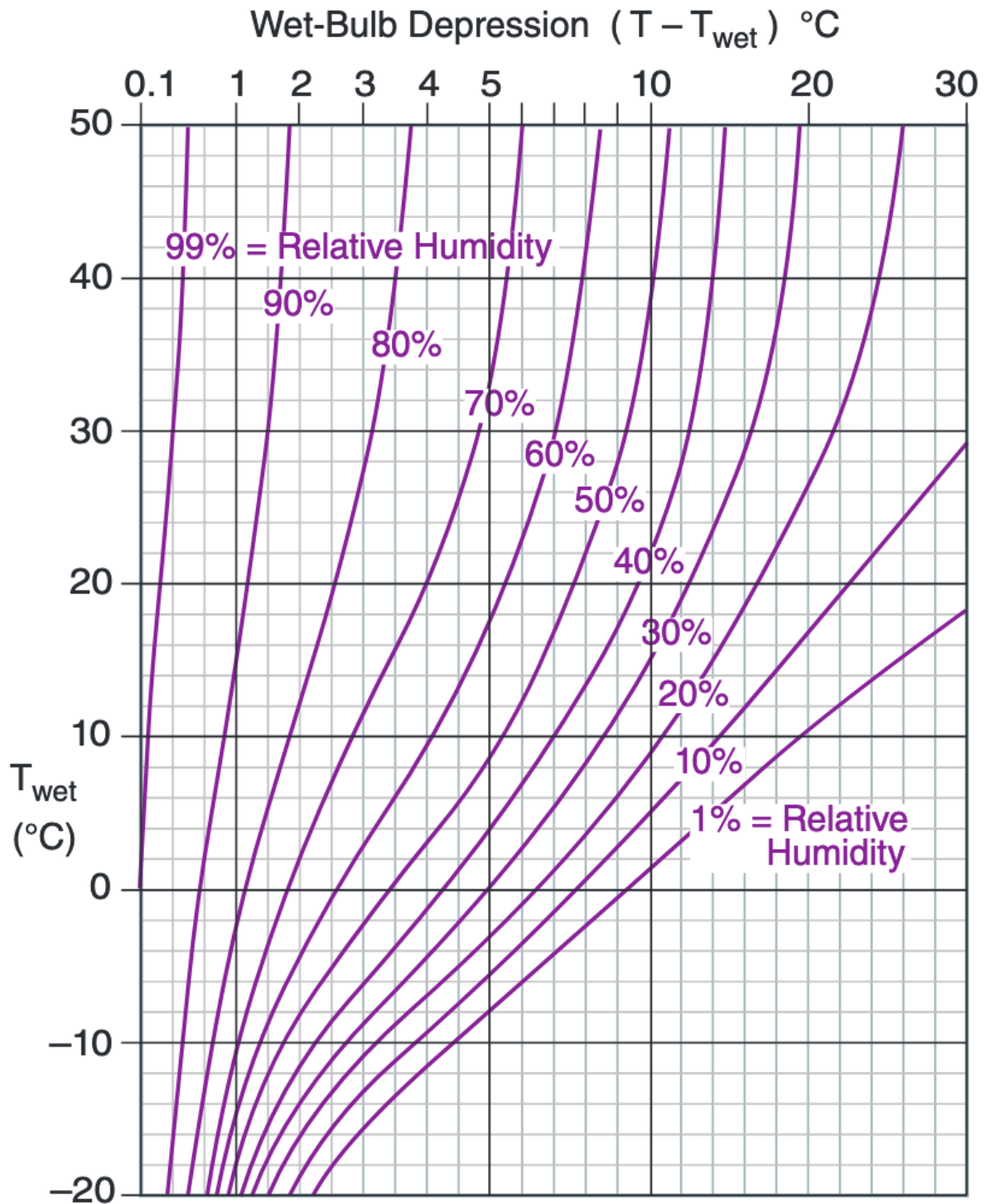


Figure 8.6. Psychrometric graph, to find relative humidity from wet and dry-bulb temperatures. Source: R. Stull (2017) [PDF] (https://www.eoas.ubc.ca/books/Practical_Meteorology/prmet102/Ch04-watervapor-v102b.pdf) CC BY-NC-SA.

References

Geography Department, Langara College.(2017). *Geography 1180 Lab Manual*.

Stull, R. (2017). *Practical meteorology: An algebra-based survey of atmospheric science, version 1.02b*. University of British Columbia.

Lab 09: Surface Water Budget

Gillian Krezoski

Where precipitation goes once it reaches the Earth's surface can be studied using a **water budget**, or **surface water balance**. Similar to a bank account, water can be **deposited** and **stored** in the soil profile as soil-water storage. If the soil-water **account** becomes too full, some of the water flows overland to become **surface water**. Sometimes additional **expenses** like environmental use through **evapotranspiration** can remove some of the water from the **bank**, and in some locations where usage is high, could create a deficit. This lab will use a simple bucket model to examine soil surface water budgets.

Learning Objectives

After completion of this lab, you will be able to

- Calculate a simple soil surface water budget.
- Understand how water is distributed and utilized at the Earth's surface.
- Learn about online sources for climate data (Environment and Climate Change Canada (<https://www.canada.ca/en/services/environment.html>)).
- Learn about local evapotranspiration resources for agriculture (Farmwest.com (<https://farmwest.com/>)).
- Begin to hypothesize how water resources could be impacted by the changing climate.

Pre-Readings

The Water Cycle

The water cycle is the global circulation of water from oceans through the atmosphere back to the oceans or to the land and from there to the oceans by overland and subsurface routes. Water is always on the move. Key aspects of the water cycle are:

- **Evaporation**, in which water transforms to a vapour, and moves into the atmosphere. It takes place from all surfaces that contain moisture, ranging from a free water surface on the ocean to the moisture on a leaf.
- **Precipitation**, in which atmospheric water vapour condenses to a liquid or solid form. It falls in various forms – snow, rain, hail, and is also deposited on the surface of the earth by the formation of dew and frost.

- **Storage.** Water is stored for varying lengths of time in a number of forms and locations including atmospheric moisture, water in swamps and lakes, soil moisture, groundwater, ice in glaciers, and snow on the ground.
- **Movement.** Water is transferred from one location to another by surface runoff, infiltration from the surface, groundwater flow, and via atmospheric vapour carried by winds.

The most important aspect of the hydrological cycle is not the quantity of water residing in the world's water bodies and atmosphere at any particular instant but rather the rates at which water is transported from one part of the cycle to another. As it moves, water is constantly reacting with its physical, chemical, and biological environment, changing its state, (liquid, vapour, and solid) and reshaping the face of the earth and allowing life as we know it (Environment and Climate Change Canada: The hydrologic cycle (<https://open.canada.ca/data/en/dataset/1b9ef470-5575-5986-a3e6-c18f49402e99>)).

Water Budgets

Most physical geography introductory textbooks have a segment discussing water budgets. For example, Christopherson et al. (2019) includes a section called **Water Budgets and Resource Analysis**. Simply put, water budgets are one method used to account for the gain and loss of water from a defined reservoir. Here we investigate the simple bucket methodology for a water budget, which forms the conceptual basis of many more complicated models of water movement.

The Bucket Methodology

The monthly water **bucket** methodology was first used in the 1940s and 1950s to improve our understanding of the relationship between climate and agriculture (e.g. to determine irrigation needs). It has been applied in many different ways over the years and although modern models have many more features, a simple bucket model still forms the core of many climate modelling concepts (Figure 9.1).

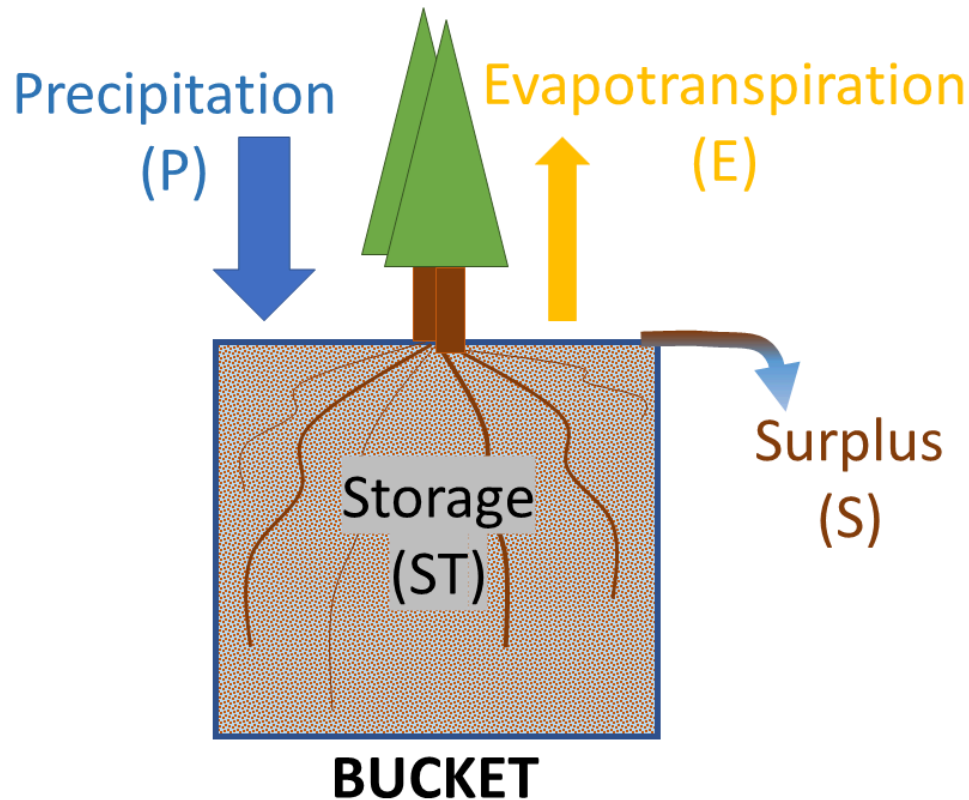


Figure 9.1. A simplified bucket model. The bucket (assumed to contain soil) is filled by water entering the air spaces. Precipitation provides the water input. Water leaves the bucket by evapotranspiration (E) through the tree and root system and directly from the surface, and surplus (s) overflow (outputs). Water that remains in the bucket is called storage (ST). Source: C. Welch, CC-BY-NC-SA 4.0.

The bucket methodology works as follows:

1. Imagine a point on the ground surface of Earth as a bucket (Figure 9.1). As it rains (**precipitation, P**), water soaks into the soil becoming soil-water **storage (ST)**. This soil-water begins to fill the bucket.
2. Water leaves the bucket by **evapotranspiration**, the name we give to the amount of water that is **evaporated** (turned from liquid to vapour) or **transpired** (drawn up by plants and evaporated from their leaves) from all elements of the environment (plants, animals, soil, etc.). This is called **utilization**.
3. If there is more precipitation than evapotranspiration, the bucket will fill. Once there is no more room for water in the bucket (i.e. the bucket is full), the bucket **overflows** and any more precipitation becomes **surplus (S)**. This water will run off to streams and flow out of the area.
4. We can further classify evapotranspiration into two types:
 - **Actual evapotranspiration (AE)** – the **actual** amount of water that is evapotranspired; and

- **Potential evapotranspiration (PE)** – the amount of water that **could** be evapotranspired at the current climate conditions if there was ample water available in the bucket.

For example, let us consider a dry, hot and windy desert. In this type of location the **potential** for evapotranspiration is quite high, because low atmospheric moisture, high air temperature, and wind all increase the rate of evapotranspiration. However, when there is very little water available in the soil or from precipitation, such as in this desert, the **actual** evapotranspiration is quite low.

Another example is a refrigerator. **Potential** is related to how hungry you are, but **actual** is related to how much food you have available in the refrigerator to eat.

5. The starting point for a water budget is therefore to compare the inputs (P) to the potential demand (PE). If there is lots of precipitation, or lots of water in storage, then the actual evaporation (AE) might be able to keep up to the potential evaporation.

However, if the precipitation is low, or the soil-water storage is low, then there may not be enough water available for the plants to use and AE might be lower than PE. This can create a **water deficit (D)** in the environment, where the environment does not have enough water coming in, or contained in storage, to keep up with demand.

Once there is a deficit, plants and the environment are not able to satisfy all of the demands they have for water, which will create stress. A moisture deficit can be a major limiting factor to most biomes (i.e. plant and animal survival).

6. The deficit has to be made up with precipitation before the bucket begins to fill up again (soil-water **recharge**).

Example Bucket Water Budget

A simplified sample annual water budget of the South Okanagan at elevation (between Penticton and Osoyoos) is included below (Figure 9.2, based on Table 9.1). In this case, the amounts of precipitation, evapotranspiration, surplus and storage are all expressed in millimetres (mm). The size of the bucket, which represents the **Water Holding Capacity** (WHC) of the soil, has been set to be 150 mm of storage available in the soil column.

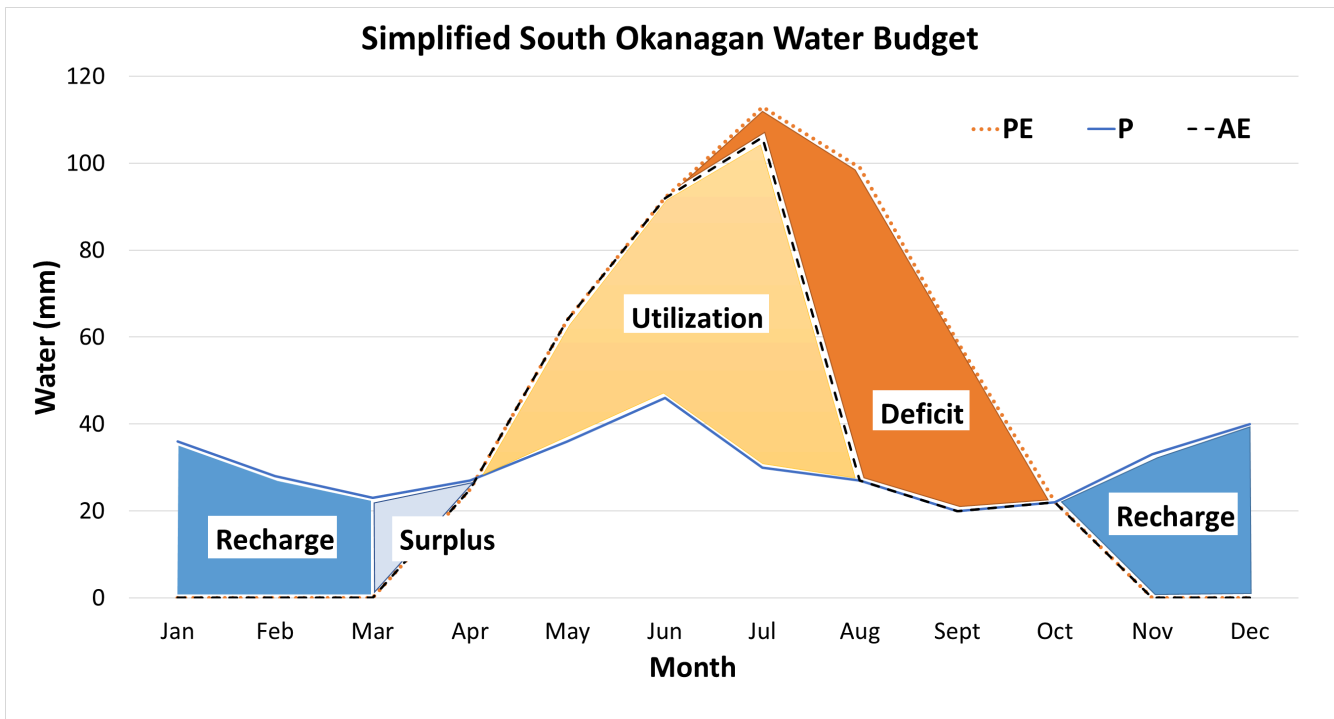


Figure 9.2. Simplified modeled water budget of the South Okanagan at elevation based on Table 9.1. 119.5W, 49.5N, curve C. Bucket capacity (water-holding capacity or WHC) is 150 mm. PE = Potential Evapotranspiration, P = Precipitation, AE = Actual Evapotranspiration. Source: G. Krezoski, CC-BY-NC-SA 4.0.

Table 9.1. Modeled water budget of the South Okanagan. All units in mm unless otherwise indicated. WHC = 150mm. Δ ST = change in storage. Refer to the Supporting Material for an explanation of how variables are calculated. Monthly mean Temp, PE, and P values sourced from *WebWIMP* (<http://climate.geog.udel.edu/~wimp/>). Source: G. Krezoski, CC-BY-NC-SA 4.0.

Month	Temp (°C)	PE	P	P – PE (DIFF)	ST	Δ ST	AE	D	S
Jan	-10.4	0	36	36	109	36	0	0	0
Feb	-6.5	0	28	28	137	28	0	0	0
Mar	-2.2	0	23	23	150	13	0	0	10*
Apr	2.7	25	27	2	150	0	25	0	2*
May	7.3	64	36	-28	122	-28	64	0	0
Jun	11.1	92	46	-46	76	-46	92	0	0
Jul	14.3	113	30	-83	0	-76	106	7	0
Aug	13.7	99	27	-72	0	0	27	72	0
Sept	9.0	59	20	-39	0	0	20	39	0
Oct	3.0	22	22	0	0	0	22	0	0
Nov	-4.3	0	33	33	33	33	0	0	0
Dec	-8.6	0	40	40	73	40	0	0	0
Total	–	474	368	–	–	–	356	118	12

In the winter months precipitation (P) includes some rainfall but mostly snowfall. During this period, the bucket is filling up during a **recharge** phase, which is expressed in Table 9.1 as storage (ST). Surplus (S) water escapes via stream systems rapidly in the late spring, often causing flooding.

One should note that because of snowmelt occurring in the late spring, the South Okanagan – especially at elevation – is a bit more complex than Table 9.1 suggests. Since that snow already fell as precipitation earlier in the year, it is not accounted for in this simple soil-water balance exercise. In reality, the surplus in the spring is much higher due to the snowmelt.

The South Okanagan is a high-latitude desert so evapotranspiration needs (PE) are quite high during summer. As the summer gets warmer, the soil-water storage (ST) is gradually depleted, actual evapotranspiration (AE) decreases, and a deficit (D) is created.

Vegetation native to the area experiences a deficit all summer and has strategies to survive the low water conditions until some rain appears in the fall. However, agriculture is common in the South Okanagan, with fruit trees and grape vines common crops. These plants are not adapted to the naturally dry environment and would be permanently harmed by the natural summer water deficits. Therefore, farmers supply the plants with extra water through irrigation from reservoirs. This supplementary water

is used to fulfill agricultural needs and prevent soil-water deficits that could harm the crops until the winter recharge can occur.

To summarize, evaporation indicates movement of water away from a wet surface into a dry atmosphere. Transpiration is where plants release water from their leaves into the atmosphere that has made it through their root/trunk/branch system. On a hot day, trees transpire more than cold days (tree sweat!). Once the growing season starts (typically after freezing temperatures cease), plant needs in the environment increase and evapotranspiration increases. Growing seasons can vary throughout the province based on temperatures and precipitation. If the summer months experience dry periods, and plants begin using water from the soil-water storage (the **bucket**), eventually the soil-water storage might empty, and irrigation will be needed to reduce the local water deficit.

Lab Exercises

In this lab you will:

1. Look at Environment and Climate Change Canada Climate Normals data (https://climate.weather.gc.ca/climate_normals/index_e.html) (30-year datasets) to understand average local annual 'inputs' into your given station.
2. Examine local evapotranspiration (an **output** from your water budget) using Farmwest.com (<https://farmwest.com/>), an agricultural resource used by farmers to plan for irrigation needs in times of deficits.
3. Complete a modeled water budget local to your (or your school's) area to determine where your water goes once it reaches the Earth's surface:
 - Into the **bucket** as soil-water storage
 - Out of the bucket as surplus (to become surface water flows)
 - Out of the bucket via evapotranspiration (environmental utilization)
4. Create your own water budget graph similar to Figure 9.2.

EX1: Reviewing Climate Normals

Step 1: Visit the Environment and Climate Change Canada Canadian Climate Normals webpage (http://climate.weather.gc.ca/climate_normals/index_e.html) (1981-2010 data).

Step 2: Your instructor will assign you a station name local to the area you are studying. Navigate to the station name.

Station Name: _____

Step 3: Scroll down to see a climograph where average monthly temperatures (lines) and average monthly

precipitation (bars) are plotted together over the course of a year using Climate Normal data (30-year data-set from 1981-2010).

Step 4: Take a screen capture of the climograph for use with the Reflection Questions at the end of this lab.

Step 5: Click on the **View Data Table** tab in the lower middle portion of your screen below the Temperature and Precipitation graph. The data that are used to plot the climograph are included here. You might want to refer to this data in your answers if you cannot determine numbers from the climograph on your screen. If so, click on **Download Data** in the bottom right of the new screen.

Once you have completed Step 1 through Step 5, answer the following questions:

1. Briefly describe quarterly (Jan-Mar, Apr-Jun, Jul-Sept, Oct-Dec) precipitation patterns at your study location. Be sure to identify the
 - predominant precipitation forms, i.e., snow or rain.
 - driest month.
 - wettest month.
2. Briefly describe quarterly (Jan-Mar, Apr-Jun, Jul-Sept, Oct-Dec) temperature patterns at your study location. Be sure to identify the
 - a. hottest month.
 - b. coolest month.
 - c. the approximate month(s) during which temperatures start warming enough to melt snow.

EX2: Examining Evapotranspiration

Now that we are familiar with seasonal precipitation and temperature patterns in your study area, we will examine environmental evapotranspiration needs. Farmers often use a website called Farmwest.com (<https://farmwest.com/>) to view local precipitation inputs, and view evapotranspiration (ET) outputs so they know how much to water their plants in order to keep water in soil-water storage for their crops to use.

The site calculates the potential evapotranspiration assuming there is always sufficient soil moisture in storage, so that irrigators can determine how much water they need to add to the soil each day to keep the soil moisture storage **topped up**. Farmwest calculates evapotranspiration for a standard grass crop (like a typical garden lawn). Farmers can calculate ET for their particular crop based on standard calculations and may have to use more or less water than a typical grass lawn. How, when, and for how long, farmers irrigate is a complex science.

Step 1: Navigate to the Evapotranspiration (<https://farmwest.com/climate/calculators/evapotranspiration/>) page on the Farmwest website.

Step 2: On the website, enter the station information provided by your instructor for your study location. For **Select Date Range** use January 1 – December 31 of the previous full year. Click **GO**. Note that we are using

a different date range than our Climate Normals (1981-2010) because 1991-2020 Climate Normals data are not available yet. This is because not all current station data is available for 2010 or earlier on Farmwest.com.

Station information:

Province: _____

Region: _____

Station: _____

Step 3: Scroll down to the two graphs at the bottom of the screen. The upper graph shows evapotranspiration (ET). The green curve is the historical average, and yellow line is the current year. The lower graph shows precipitation events throughout the year.

The graph of evapotranspiration over the year can be presented in two ways. By default it plotted as a cumulative graph on the Farmwest website, where the total ET over the season can be seen. This graph will rise steadily from zero at the start of the graph and will be steepest when daily ET is highest. This type of plot is useful for tracking the total amount of water needed for irrigation over a whole season.

Step 4: Go back to the top of the page where you entered your settings and find the small tick box where you can also choose **Not cumulative in graphical display**. Click on this option, then click **GO** again, and re-examine the graph. Now, the daily amount of ET is shown. This graph will rise and fall over the year as climate conditions change and is useful for seeing how daily climate impacts ET. It may be helpful to download the data by clicking the dropdown menu for each graph and selecting **Download CSV**.

Once you have examined the graphs, answer the following questions. Limit your answers to 1-2 sentences.

3. A plot of daily evapotranspiration over one year is a curve with the highest point in the summer and lowest in the winter. Explain why based on your understanding of evaporation and transpiration.
4. Examine the local precipitation events and the yellow line indicating evapotranspiration. Is there a relationship between these two variables? Why or why not?
5. What other data set would give you some information about the changes to evapotranspiration over time? Why?
6. Precipitation events occur in the winter, but the evapotranspiration curve does not change. Why is this?

EX3: Completing a Water Budget

A water budget can be useful for city planning and for irrigations needs. Indeed, after examining water budgets, city planners and engineers in the Okanagan built reservoirs to capture spring runoff for agricultural and city needs.

In this exercise you will complete a water budget local to your area.

Water Budget Location: _____

7. Complete water budget for your location using the Water Budget Worksheet provided in

Worksheets. Your instructor will provide you with the WHC for your location, and the first three columns of data (Temp, PE and AE). Instructions on how to complete the budget are provided in the Supporting Material. Your instructor may also provide additional instructions.

Once complete, answer the following questions in 2-3 sentences. Remember, this is individual work.

8. What is the driest month (lowest Precipitation), and what is the month of greatest moisture stress (highest Deficit)? Are they the same? Explain your answer.
9. What is the wettest month (highest Precipitation), and what is the month of greatest moisture surplus (highest Surplus)? Are they the same? Explain your answer.
10. What is causing most of the seasonality: annual temperature differences or precipitation? Explain your answer. Be sure to consider Potential Evapotranspiration (PE) in your discussion.

EX4: Plotting a Water Budget

11. Plot your water budget data using Excel (or similar software) to create a visual water budget. Refer to Figure 9.2 as an example.
 - a. Plot your PE, P and AE values for the year.
 - b. Draw by hand (and scan back in) or use PowerPoint or Word to create polygons for Recharge, Deficit, Utilization and Surplus zones. Note that recharge ends once the WHC has been reached.
 - c. Be sure to include a descriptive title, axis labels with units, and an appropriate legend.

Reflection Questions

In general, it is accepted that British Columbia's climate will become hotter and drier in most places due to climate change. Considering precipitation, temperature, and evapotranspiration (both AE and PE) examined in this lab, take 15-20 minutes to answer the following questions:

1. How do you think climate change might impact your study area's water budget in 50 years? Include trends in inputs (P) and outputs (PE, AE) in your discussion and explain why. Be sure to mention deficits and surpluses as well.
2. What sorts of things can be done to remediate future water budget challenges? Include at least three examples in your discussion. If you mention a reservoir or similar, refer to your water budget and explain where the water would come from. Can human usage be changed, given that populations are likely to increase?

3. Describe how your Farmwest.com evapotranspiration curve will change as the climate changes. How would this influence farmers' actions for their crops?
4. The simple monthly bucket model used in this lab considered the soil-water storage as a **bucket**. Is this strictly true of the ground? Describe where else water in the soil goes, and when during the year this is most likely to occur. Review the water cycle if necessary.

Worksheets

Back to EX3

Water Budget Worksheet

- Lab 09 Water Budget Worksheet [Word] (<https://pressbooks.bccampus.ca/geoglabmanualv2/wp-content/uploads/sites/1340/2020/07/Lab-09-Water-Budget-Worksheet.docx>)
- Lab 09 Water Budget Worksheet [ODT] (<https://pressbooks.bccampus.ca/geoglabmanualv2/wp-content/uploads/sites/1340/2020/07/Lab-09-Water-Budget-Worksheet.odt>)
- Lab 09 Water Budget Worksheet [PDF] (<https://pressbooks.bccampus.ca/geoglabmanualv2/wp-content/uploads/sites/1340/2020/07/Lab-09-Water-Budget-Worksheet.pdf>)

Supporting Material

Back to EX3

How To Do A Water Budget Analysis

1. Your instructor will supply mean monthly temperature, PE and P, plus a value for the water holding capacity (WHC) for the soil at your site. The WHC is equal to the maximum value of soil water storage (ST).
2. You can start your calculations at any time in the water balance, preferably at a time you know something about the soil moisture conditions (i.e. either full or empty), e.g., assume soil moisture is full – at WHC – in January: enter your WHC value in the ST column for January.
3. Calculate $P - PE$ (DIFF) for your location.
4. Determine your change in storage (ΔST) value based on the DIFF value

If the DIFF is positive, there is extra water, so

- Fill up the soil moisture reservoir (if applicable) if it is not full (equal to the WHC). ΔST will be positive.

If ST (prior month) + $DIFF$ is greater than WHC ,

$$\Delta ST = WHC - ST \text{ (prior month)}$$

Remainder of DIFF becomes S (see step 8, below).

If the $DIFF$ is negative, there is a water need

- Determine the amount of moisture to be extracted from the soil. ΔST will be negative.

If ST (prior month) + $DIFF$ is greater than zero, then there is sufficient soil water remaining

$$\Delta ST = -DIFF$$

If ST (prior month) + $DIFF$ is less than 0, the soil moisture storage is empty,

$$\Delta ST = -ST \text{ (prior month), or } 0$$

Remainder of DIFF becomes D (see step 7, below)

5. Calculate ST

If $DIFF$ is negative

$$ST \text{ (current month)} = ST \text{ (prior month)} + \Delta ST \text{ (current month)}$$

If $DIFF$ is positive

If ST previous month = WHC

$$ST \text{ (current month)} = WHC$$

If ST previous month is less than WHC

$$ST \text{ (current month)} = ST \text{ (prior month)} + DIFF$$

OR

$ST = WHC$ if $(ST \text{ previous month} + DIFF)$ is greater than WHC

6. Calculate AE

If $DIFF$ is positive (more than enough water from precipitation for the month)

$$AE = PE$$

If $DIFF$ is negative (we are taking water out of the bucket, or ST)

$$AE = P - \Delta ST$$

7. Calculate Deficit (D)

$$D = PE - AE$$

8. Calculate Surplus (S)

If DIFF is negative

$$S = 0$$

If DIFF is positive then

If ST (prior month) = WHC

$$S = \text{DIFF}$$

If ST (prior month) is less than WHC

$$S = \text{DIFF} - (\text{WHC} - \text{ST prior month})$$

9. Balancing the budget

Continue your calculations for all months of the year until you fill in the table and return to the month you started with. If at this point your ST is not the same as the value you began with, you need to repeat the entire procedure until you **balance** the water budget, and the values for ST in the starting month match. Very rarely you may have to repeat the entire procedure twice to balance the water budget.

10. **Check your results using this annual balance:** Annual AE + Annual D = Annual PE and
Annual AE + Annual S = Annual P

References

Christopherson, R.W. et al., (2019). *Geosystems: An Introduction to physical geography* (4th ed). Pearson Canada Inc.

Environment and Climate Change Canada. (n.d.). *The hydrologic cycle*. Government of Canada. <https://open.canada.ca/data/en/dataset/1b9ef470-5575-5986-a3e6-c18f49402e99>.

Environment and Climate Change Canada, (n.d.). *Canadian climate normals 1981-2010 station data*. Government of Canada. https://climate.weather.gc.ca/climate_normals/index_e.html.

Farmwest.com (2020). *Evapotranspiration*. <https://farmwest.com/climate/calculators/evapotranspiration/>.

Web WIMP version 1.02 (<http://climate.geog.udel.edu/~wimp/>). (2009). Implemented by K. Matsuura, C. Willmott and D. Legates at the University of Delaware in 2003.

Lab 10: BC Soils and Relationships to Vegetation and Climate

Nina Hewitt

Soils are fundamental to life on land. Soils supply water, nitrogen, and all of the mineral nutrients (potassium, calcium, etc.) to photosynthetic plants, which are the base of food webs in terrestrial ecosystems. Soils are the medium in which plants root and gain support, and they host the micro- and macro-biota that break down and cycle organic nutrients in ecosystems. Viewed in profile, one can see distinctive horizontal layers through a soil column that reflect the age of the soil and the particular environments in which the soil formed. These layers are called **horizons**. With some knowledge and a good eye, it is possible to **read** or interpret soil processes based on their visible characteristics.

In this lab we will explore some important soil types in BC, their properties visible in a vertical profile, and the related formational processes. At the end of the lab, you should be able to begin describing and interpreting soils in the field.

Learning Objectives

After completion of this lab, you will be able to

- Name and describe most major soil types (orders) present in BC.
- Identify the soil profile characteristics that define these soil orders.
- Name and describe the major mineral horizons and some sub-horizons in soils.
- Visualize a variety of soil profiles and how their properties change with depth.
- Relate soils to climate, biogeoclimatic zones, and parent materials.
- Relate soil profile characteristics such as colour, texture and horizon depth to soil processes such as eluviation and organic matter deposition.
- Work with resources for visualizing and studying soils and ecosystems including Google Earth (Web), UBC's SoilWeb, ClimateBC, BC's Biogeoclimatic Ecosystem Classification (BEC zone) System, and the Canadian System of Soil Classification (CSSC).

Pre-Readings

Soil Formation and Parent Materials

Soils form in place over periods of **time** under the influence of other **soil forming factors** (<https://soilsofcanada.ca/soil-formation/factors.php>): **climate** (heat and moisture), **organisms**, **topography**, and **parent materials**.

Parent materials determine the mineral building blocks of most soils, and vary considerably from place to place. They are classified according their mineral characteristics, whether they are bedrock or deposits, and if the latter, the mode of deposition. For further details consult Soil Formation and Parent Material (<https://landscape.soilweb.ca/>); paying special attention to colluvial, glacial, lacustrine.

Glacial till is important in BC, and is comprised of varying grain sizes from fine silt and clay to coarser sand, gravel and boulders of mixed lithology (mineral composition). Till often occurs in a sequence of a layer of **ablation till** overlying more compacted **basal** or **lodgement till**. Watch the videos Ablation till (<https://www.youtube.com/watch?v=s3XXu92L0a4>) and Basal Till (<https://youtu.be/uE6XVMd49ww>) if you would like a more detailed description of the formation of each till type.

Modern soil science recognizes that soils are a product of **processes** acting upon soils, their biota, and parent materials. At the most general level, these include additions, losses, transformations, and translocations (<http://soilweb200.landfood.ubc.ca/soil-classification/2-soil-formation-processes/>). More specific key processes include:

- **organic matter decomposition** that releases and cycles nutrients, and adds **humus** (colloidal, decay-resistant organic particles);
- **chemical weathering** of minerals to produce fine colloidal silicate clay particles;
- vertical translocations such as **eluviation** and **illuviation** that contribute to horizon formation in rainy climates. Watch this video of Examples of Eluviation and Illuviation Soil Formation Processes (<https://youtu.be/N266Tc4Kuw8>) for further details.

Soil Profiles and Properties

To study soils we use the **soil profile**: a vertical cross-section, or side-on view, of about 1 metre depth (Figure 10.1).

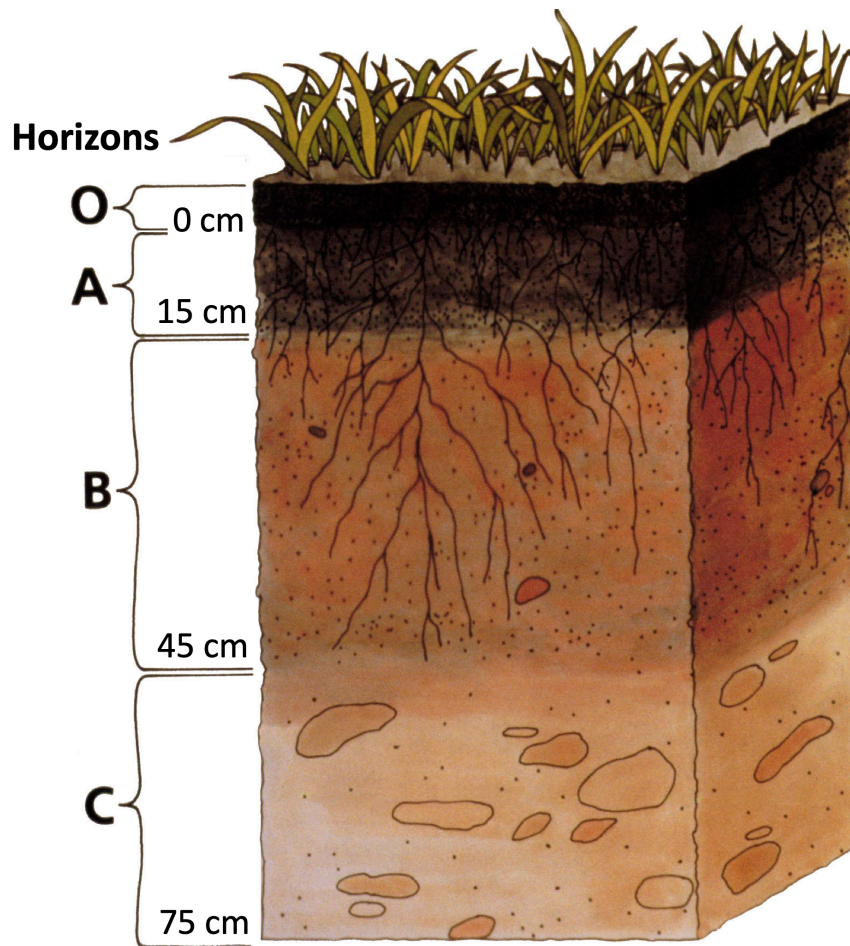


Figure 10.1. Diagram of a soil profile showing approximate positions of major horizons (organic, O) and mineral (A, B, C). Not all horizons will be present in a particular soil. Source: US Department of Agriculture (https://commons.wikimedia.org/wiki/File:Soil_profile.png). Public Domain. [Image description]

Soil profiles are normally described at two levels:

1. in the field, different horizons are identified and described using simple observable properties such as colour and texture (feel method) and
2. samples taken from each horizon identified are later subjected to detailed physical and chemical analysis in the laboratory.

The soil characteristics that can be assessed in the field, and which you may see evidence of in this lab, include:

- **Colour**, using standardized colour charts.
- **Texture**, typically classified using the **feel** of the soil.
- **Structure**, i.e., the aggregation of soil particles into units or **peds**.
- Miscellaneous special features, such as mottles, roots and pores.

Using these properties, one can identify relatively homogeneous horizontal layers or **horizons** within each soil profile.

Departments of agriculture in different countries have developed slightly different conventional horizon designations. In Canada, **major horizons** are designated by capital letters. **Non-mineral horizons** are designated by the letters **O, L, F** and **H**; **mineral horizons** by **A, B, C** and **R**). Each major horizon can be given one or more lowercase suffixes (such as **e** for **eluviated**, **t** for clay accumulation, **g** for **gleyed** and **f** for **ferric iron** in mineral horizons). These suffixes denote **sub-horizons** of the soil. We will encounter only a subset of these, which you will find described in your textbook. For a complete description of horizons and lowercase suffixes, see CSSC (1998) Chapter 2: Soil, Pedon, Control Section, and Soil Horizons (http://sis.agr.gc.ca/cansis/taxa/cssc3/chpt02_a.html#soilhorizons).

Details of Observable Features Used in the Field Description of Soils

In addition to labelling the major horizons and their lowercase suffixes, soil properties typically noted during field descriptions of soils are detailed in Table 10.1.

Table 10.1. Observable soil properties noted in the field description of soils.

Soil Property	Description
Colour	<p>Defined using a series of standardized Munsell soil colour charts:</p> <ul style="list-style-type: none"> • Each page comprises a separate hue and is given a letter and number designation (e.g., 7.5YR). • Separate colour chips are arranged on each page of the chart on a vertical axis of darkness called a value and a horizontal axis of colour intensity called a chroma. A particular value and chroma combination is indicated by two numbers as such: 5/2. • One or more colour chips are also given verbal descriptions, and a complete colour description of the soil uses both the verbal and numerical descriptions, e.g., 7.5YR 5/2 Brown. <p>To use the colour charts, a moist (or both a dry and a moist) sample of the soil on the fingertip is compared with chips through the holes in the chart until a match is found. Note that when using the charts, it is necessary to be careful not to dirty the chips – the books cost over \$ 100 each! Watch this demonstration of Soil Colour determination in the field (https://youtu.be/xuEfrHhb6Sg) for more information.</p>
Texture	<p>Conventionally refers to soil particles smaller than 2mm in diameter, which are separated into three textural classes:</p> <ul style="list-style-type: none"> • Sand: 2 mm to 0.05mm • Silt: 0.05 mm to 0.002 mm • Clay: < 0.002 mm <p>Clay tends to feel greasy and untextured, silt slightly textured, whereas with sand you can feel the individual grains between your fingers. By expressing the proportions (by weight) of each textural class as a percentage, the textural mix of any soil can be placed on a triangular diagram, and the diagram zoned into types that are given a name. This soil texture triangle may be found in your text or lecture notes. With practice, it is usually possible to place a soil into one of these types with reasonable accuracy using only feel.</p>
Structure	<p>Refers to the aggregation of individual soil particles into units called peds. The five structural types that have been distinguished by soil scientists include granular or crumb, platy, angular blocky, subangular blocky and prism-like. Consult your text or other instructional materials for diagrams. In addition, a structureless class is recognized when soil particles show no aggregation, such as a recent sand deposit. Each structural type is also separated into three size classes, fine, medium, coarse, as defined by the diameter of the peds. A description of the ped uses both the shape and size designations, e.g., coarse granular or medium subangular blocky structure.</p>
Miscellaneous Features	<p>Include any other obvious features that can be seen in the soil horizon. Some of the most common features that are commented upon are:</p> <ul style="list-style-type: none"> • Mottles and concretions • Roots and pores • Presence of coarse fragments > 2mm in diameter, e.g., gravel, stones <p>Note the size and abundance for each feature.</p>

Horizon Boundaries	<p>At the lower horizon boundary, the transition to the next horizon is described by</p> <ul style="list-style-type: none"> • Distinctness: <ul style="list-style-type: none"> ◦ Abrupt: < 3 cm wide ◦ Clear: 3-6 cm wide ◦ Gradual: 6-12 cm wide ◦ Diffuse: > 12 cm wide • Form (Figure 10.2): <ul style="list-style-type: none"> ◦ smooth ◦ wavy ◦ irregular ◦ broken
--------------------	---

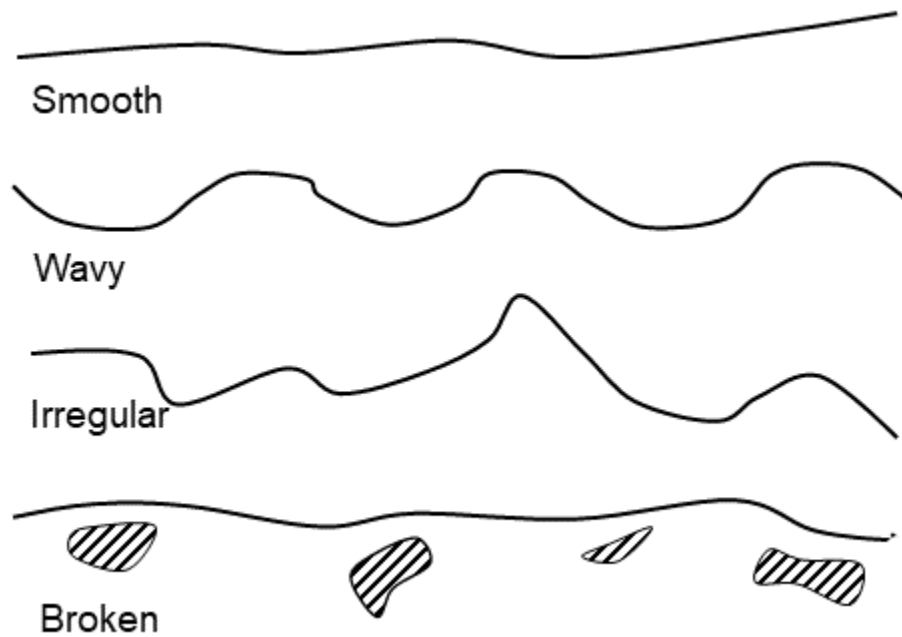


Figure 10.2. Soil horizon boundary forms, including, from top to bottom, smooth, wavy, irregular, and broken. Source: N. Hewitt, CC BY-NC-SA 4.0.

Gleying is a process in which metals in the soil such as iron (and sometimes manganese) are reduced, producing blue-grey colours in soils, often with mottling (Figure 10.3). When oxygen is present, iron is oxidized and has a reddish colour. Under situations of periodic water-logging, such as from a seasonally raised water table, oxygen is depleted, the iron is reduced and takes on a blue-grey hue.

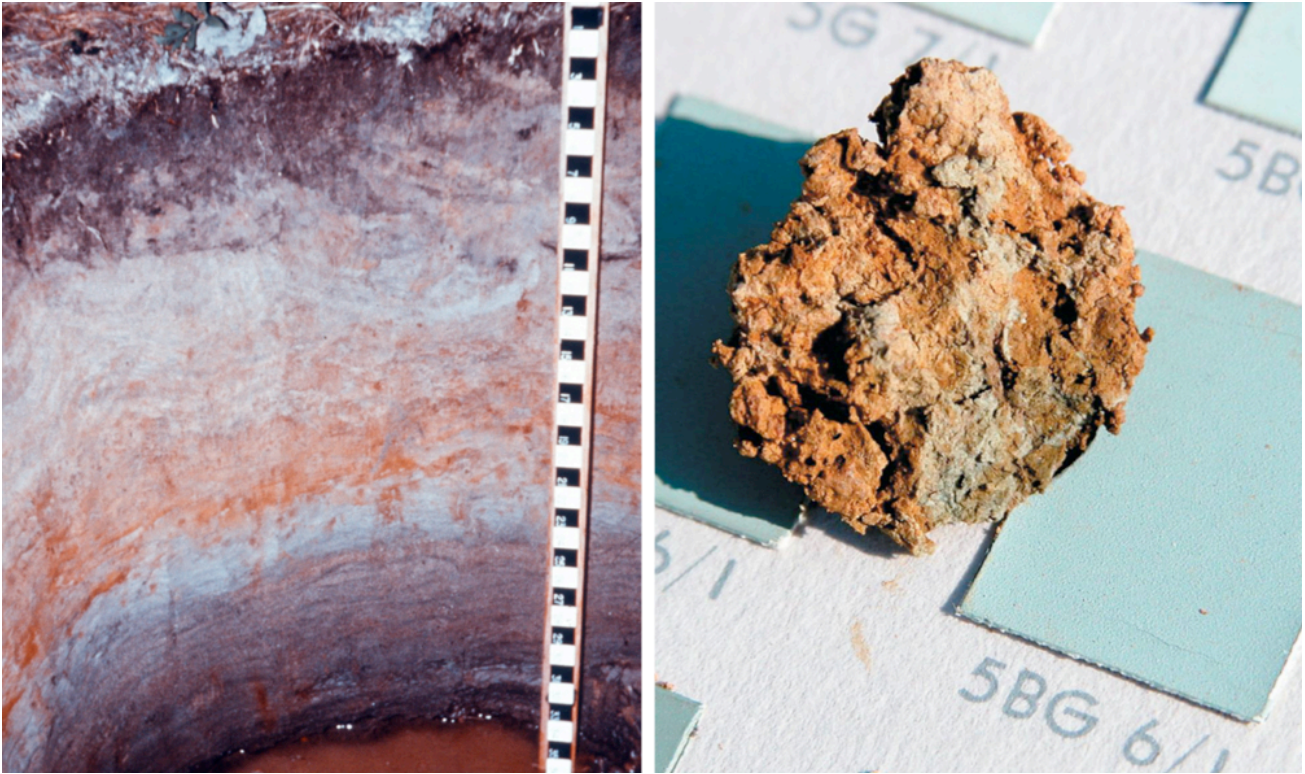


Figure 10.3. Left- A sandy soil with gleyed horizons below about 1 foot depth, where blue-grey colors (indicative of iron reduction) are present amid orange-red (oxidation) mottles. **Right-** Soil ped with mottles showing presence of both oxidized iron (orange colors) and reduced (blueish) iron minerals. The latter are gley colors. Sources: Left- Agriculture and Agri-Food Canada. Used under Government of Canada terms and conditions. Right- Used with permission from R. Weil and Pearson Education.

Soil Classification in Canada

The type and combination of horizons present in the soil is used to classify the entire profile into a class of soils such as **podzols** or **gleysols**. In Canada, we use the **Canadian System of Soil Classification (CSSC)**. The CSSC identifies 10 major **soil orders** which are further subdivided. Refer to **Chapter 3: Outline of the System and a Key to the Classification of a Pedon** (<http://sis.agr.gc.ca/cansis/taxa/cssc3/chpt03.html>) for a thorough description. Table 10.2 summarizes the 10 soil orders and associated vegetation communities. Click on the name of each soil order to access a detailed description at UBC's SoilWeb's Classification (<https://classification.soilweb.ca/>) pages.

Table 10.2. The ten Canadian soil orders and associated vegetation communities.
Source: CSSC (<https://sis.agr.gc.ca/cansis/taxa/cssc3/chpt03.html>), 1998

Canadian Soil Order	Associated Vegetation
Brunisolic (https://classification.soilweb.ca/brunisol/)	Boreal forest; mixed forest, shrubs and grass; heath and tundra
Chernozemic (https://classification.soilweb.ca/chernozem/)	Grasslands
Cryosolic (https://classification.soilweb.ca/cryosol/)	Subarctic to boreal forests, alpine forests
Gleysolic (https://classification.soilweb.ca/gleysol/)	Wetland, swamp
Luvisolic (https://classification.soilweb.ca/luvisol/)	Deciduous, mixed and coniferous forests
Organic (https://classification.soilweb.ca/organic/)	Peat, bogs and fens
Podzolic (https://classification.soilweb.ca/podzol/)	Coniferous forest or heath
Regosolic (https://classification.soilweb.ca/regosol/)	Mixed
Solonetzic (https://classification.soilweb.ca/solonetz/)	Grasses and forbs
Vertisolic (https://classification.soilweb.ca/vertisol/)	Grasslands

We will be examining **Organic, Podzolic, Brunisolic, Chernozemic** and **Regosolic** soil types in this lab. Be sure you watch the videos and read the summaries on each order at the links provided in Table 10.2.

It is also recommended that you watch the following videos on UBC's SoilWeb:

- The Podzolic Order (<https://youtu.be/rjGEbYy2sbc>) (first 6 minutes or so, describing soils in the UBC Malcolm Knapp Research Forest).
- The Organic Order (<https://youtu.be/YJkoUXUTSGU>) (first 9 minutes or so, describing a profile along the Coquihalla Highway).

BEC Zones

Vegetation is not only dependent on climate and topography, but also on the soil that forms in that environment. BC's Biogeoclimatic Ecosystem Classification (**BEC**) system classifies ecosystems according to their major climate types, vegetation associations, and soil types. On this basis, land cover in BC has been classified into a series of different ecosystem types (BEC zones) including

- **Coastal Western Hemlock** and **Douglas Fir Forests** near the southern coast,
- **Englemann Spruce-Subalpine Forest** and **Alpine Tundra** in mid- to high-elevation locations of the Coast Mountains, and
- **Ponderosa Pine**, **Interior Douglas Fir** and **Bunchgrass** BEC zones in the interior.

Peruse the Biogeoclimatic Ecosystem Classification System in British Columbia (<https://selkirk.ca/discover/bec/zones/zones.html>). Hover over the zone name to view the map, and click on the zone name to see its description.

Lab Exercises

In this lab you will examine landscapes, climate and ecosystem characteristics, and soil profiles for 5 contrasting locations that represent the common soil types in BC. Specifically, you will

- Locate the sites using Google Earth imagery and examine the landscapes in terms of topography, elevation and other geographic factors.
- Determine climatic conditions for the locations using online climate maps and identify ecosystem characteristics, including dominant vegetation, using standard biogeoclimatic classifications (BEC zones).
- Examine the soil profiles of comparable soils using online information and imagery.

The lab consists of three exercises and should take 3 to 4 hours to complete. Please consult your instructor for submission requirements.

EX1: Understand the Field Locations Where Soils Will Be Examined

In this exercise you will explore the sites at which you will examine soils and identify and record the BEC zones, climate variables, and elevations of the sites. It should take you around one hour to complete. As you go, you will complete the missing values in Table 10.3.

Table 10.3. Location, BEC zone and climate of our five focal sites. DMS = degrees minutes seconds; DD = decimal degrees; T = temperature; P = precipitation.

#	Site	Geographic Coordinates (DMS; DD in brackets)	Elevation (m a.s.l.)	BEC Zone	Winter Average T (°C)	Summer Average T (°C)	Winter P (mm)	Summer P (mm)
1	Bog soil	49°08'39"N 122°56'00"W(49.144, -122.934)	5	CDF, Coastal Douglas Fir	3.5	16.7	483	136
2	Coastal needleleaf forest soil	49°15'49"N 122°33'33"W(49.264, -122.559)						
3	Subalpine forest soil	50°58'29"N 122°46'31"W(50.975, -122.774)						
4	Alpine tundra soil	50°57'59"N 122°47'42"W(50.966, -122.796)	2,083	IMA, Interior Mountain Heather (within the broader Alpine zone)	-7.3	7.4	486	174
5	Interior grassland /scrubland soil	49°05'58"N 119°42'46"W(49.100, -119.711)						

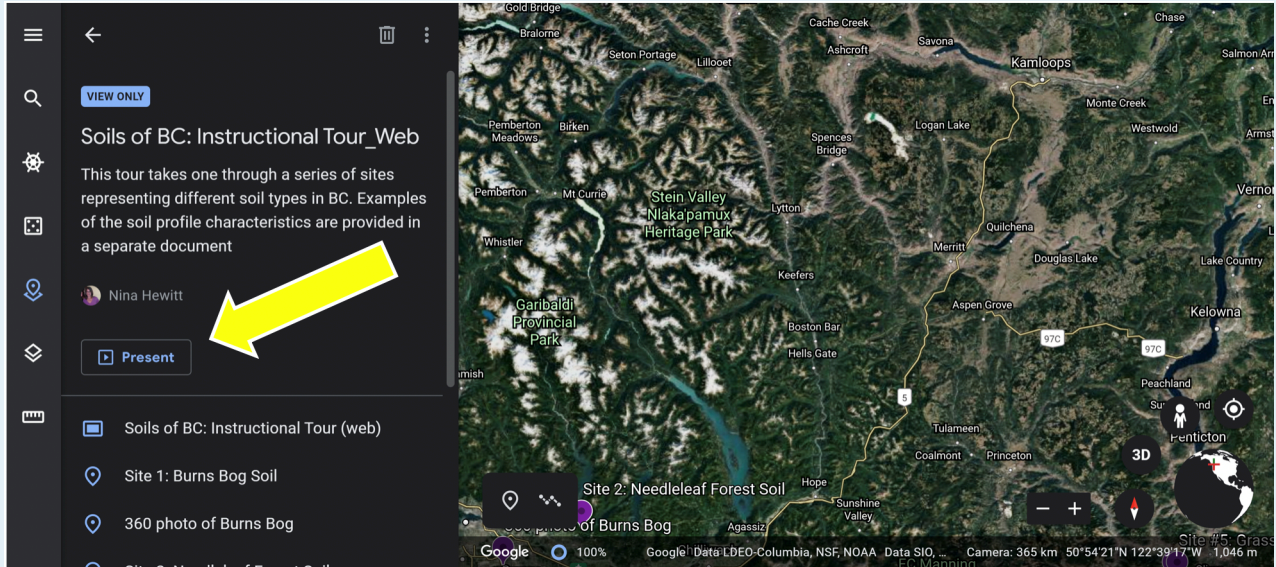
Virtual Tour and Obtaining Elevation Data

1. Soils reflect the regional geography. The five soils you will examine are located in and around Vancouver in southern coastal BC (two sites), inland and up the Coast Mountains (two sites), and in BC's southern interior (one site). A Google Earth (Web) (<https://earth.google.com/web/>) tour has been created to allow you to explore the local landscapes for each of five sites in BC and record the elevations. It should take you around 20 minutes to complete (3-5 minutes per site). Complete the tour and record the missing elevation data in Table 10.3.

Step 1: Download the Table 10.3 file to your computer from Worksheets and open it in a spreadsheet application.

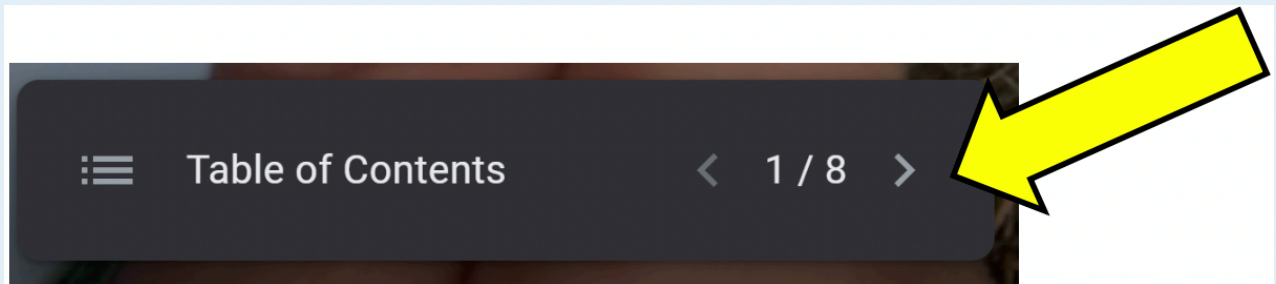
Step 2: Using your browser, download this Soils of BC Instructional Tour [KML] file (<https://drive.google.com/file/d/1Hzb9JSNF6j2q9GQLsryidaWUYsARRJRe/view?usp=sharing>), upload and open it in Google Earth (Web) (<https://earth.google.com/web/>). Alternatively, go to the online link, Soils of BC Instructional Tour. (<https://earth.google.com/earth/rpc/cc/drive?state=%7B%22ids%22%3A%5B%22182UkzVXoWuQxJF1X9NAxhDGIUZb2M4Q6%22%5D%2C%22action%22%3A%22open%22%2C%22userId%22%3A%22116924788817130860855%22%7D&usp=sharing>) This may run slowly, so the KML file is recommended for faster load/run times.

Step 3: Click **Present** to start the tour (Figure 10.4a). Visit each stop by clicking on the right arrow beside the **Table of Contents** button (Figure 10.4b).



(<https://pressbooks.bccampus.ca/geoglabmanualv2/wp-content/uploads/sites/1340/2021/03/Figure-9.2a-Soils-of-BC-Instructional-Tour.png>)

Figure 10.4a. Starting the Soils of BC Instructional Tour. Source: Google Earth Web screenshot adapted by N. Hewitt. Used in accordance with Google Earth terms and conditions. [Click to view image full size]



(<https://pressbooks.bccampus.ca/geoglabmanualv2/wp-content/uploads/sites/1032/2020/07/Figure-9.2b-Soils-of-BC-Instructional-Tour.png>)

Figure 10.4b. How to advance through the Instructional Tour. Source: Google Earth Web screenshot adapted by N. Hewitt. Used in accordance with Google Earth terms and conditions.

At each stop, explore the main window. View the images, read the text and watch any embedded videos in the information panel on the right. You can double-click the images to enlarge them. You can return to any stops using the **Table of Contents**.

Step 4: Find the elevation for each site (Figure 10.5). Place your cursor immediately below the place marker for the site in question (e.g., **Site #5: Grasslands and sagebrush soil**). Record the ground level elevation indicated at the bottom right corner of the screen in Table 10.3. **Do not confuse the ground level elevation with the camera elevation.**

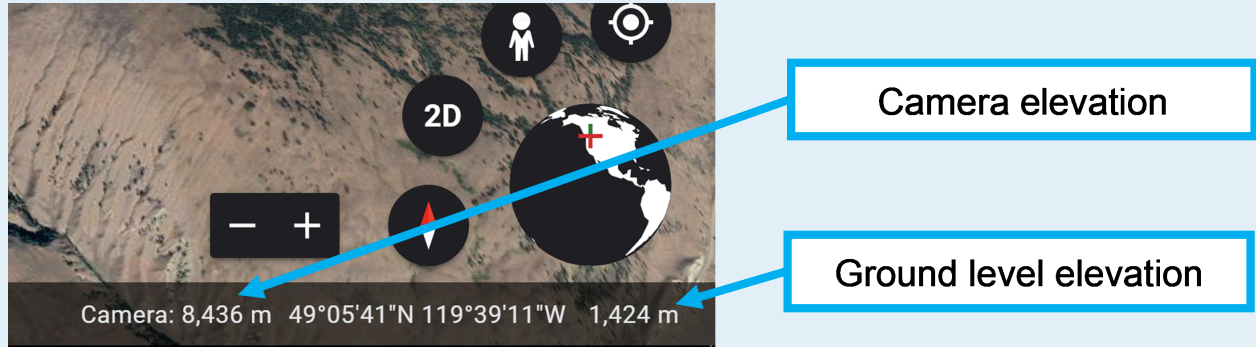
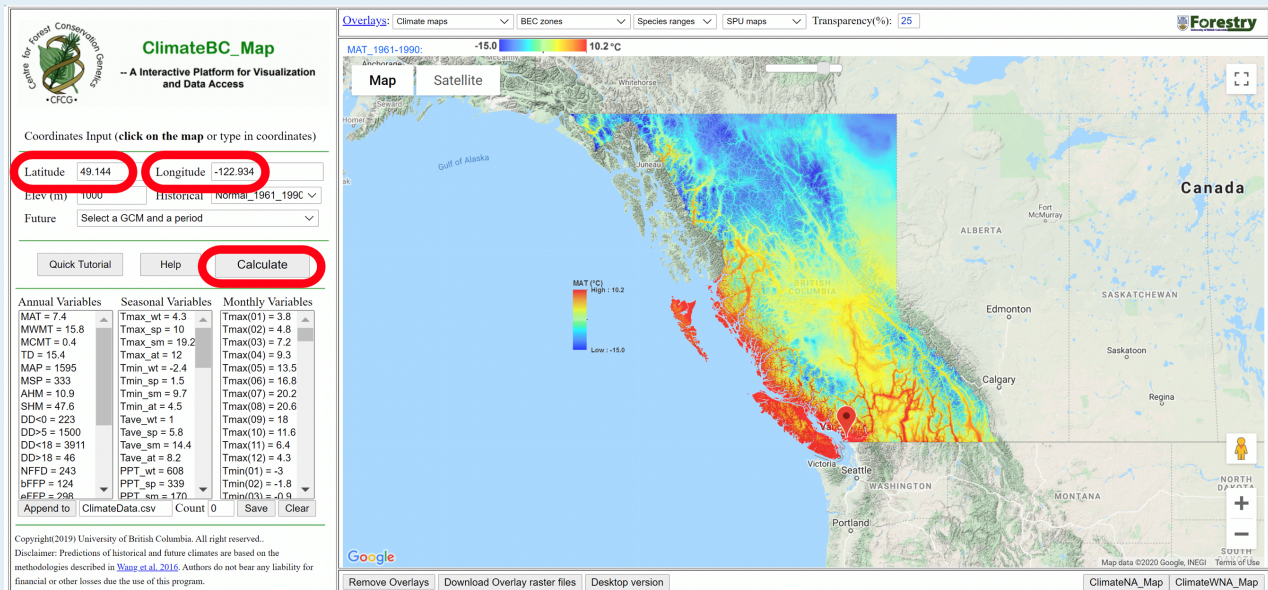


Figure 10.5. Where to find ground level elevation information. Source: Google Earth Web screenshot adapted by N. Hewitt. Used in accordance with Google Earth terms and conditions.

Climate and Biogeoclimatic Ecosystem Classifications (BEC)

- Climate is fundamental to the formation of soils and vegetation communities. Using the following instructions, identify the BEC zones and climate variables for each of the five sites, and record them in your Table 10.3. It should take you around 40 minutes to complete

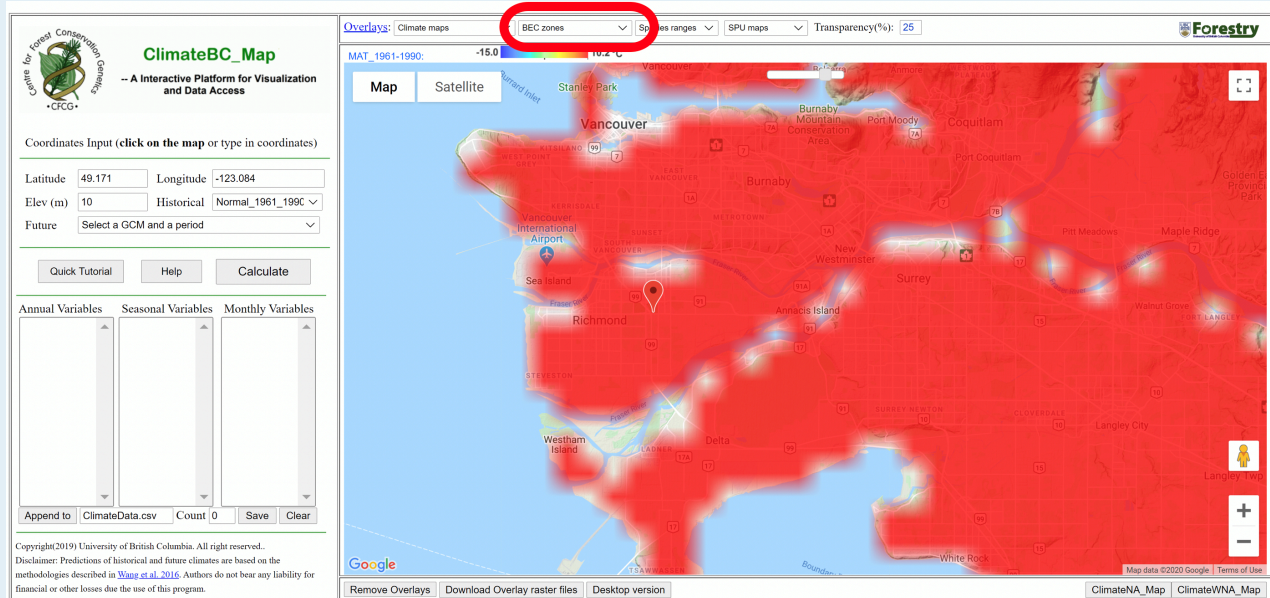
Step 1: Open the map at Climate BC website (http://www.climatewna.com/ClimateBC_Map.aspx). For each site of interest, enter the latitude and longitude in decimal degrees from Table 10.3 and hit **Calculate** (Figure 10.6). A red marker will appear on the map at the specified location. Zoom in using the +/- symbols. Double-check the location by using landmarks such as roads, rivers or lakes, based on the site’s location in the Google Earth Tour. Once you are in the right place you must manually move the cursor **slightly** by clicking on an adjacent location to your marker. This action will recalculate elevation correctly (otherwise climate data will be modelled at the elevation in the previous frame, above or below your site!). Click **Calculate** again. To see the base map better, use the slider at the top of the map to increase transparency of the coloured layers.



(<https://pressbooks.bccampus.ca/geoglabmanualv2/wp-content/uploads/sites/1340/2021/03/Figure-9.3a-Climate-BC-Website.png>)

Figure 10.6. Step 1: Entering latitude and longitude to find elevations on the Climate BC website. Source: University of British Columbia. Used with permission. [Click to view image full size]

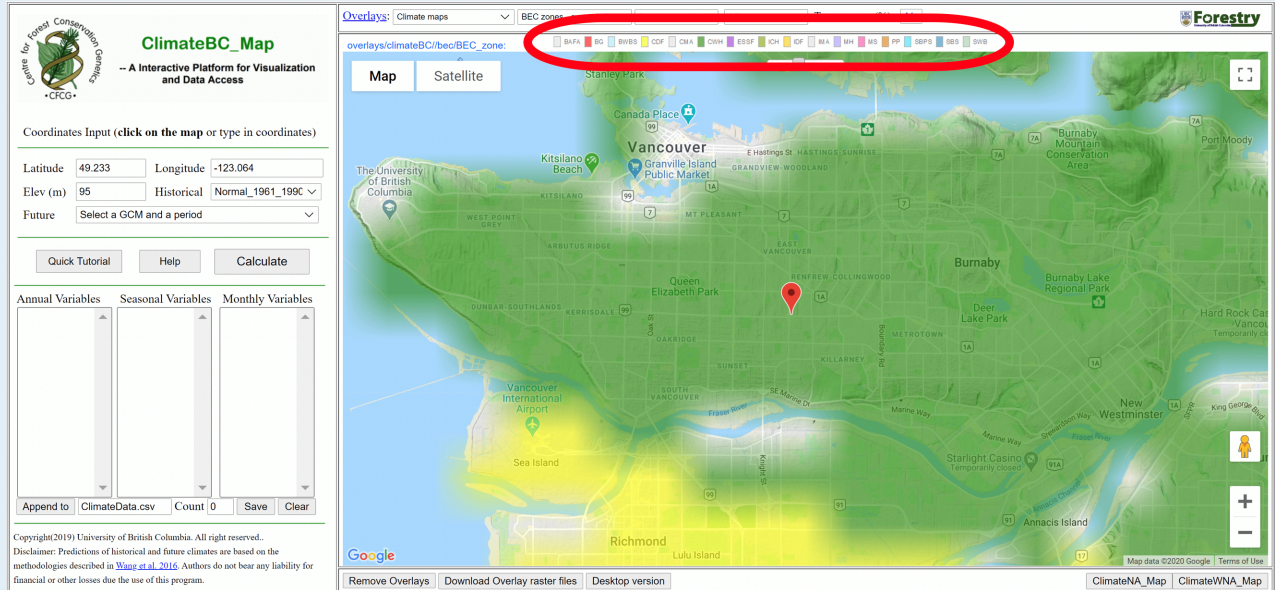
Step 2: At the top of the map, click on the **BEC zones** overlay button (2nd button from left) and select **BEC zones – currently mapped** from the drop-down menu (Figure 10.7).



(<https://pressbooks.bccampus.ca/geoglabmanualv2/wp-content/uploads/sites/1340/2021/03/Figure-9.3b-Climate-BC-Website.png>)

Figure 10.7. Step 2: Showing BEC zones on the Climate BC website. Source: University of British Columbia. Used with permission. [Click to view image full size]

Step 3: Determine each site's BEC zone using the legend along the top of the map (Figure 10.8) Record the BEC zone **abbreviation** and **full name** (<https://www.for.gov.bc.ca/hre/becweb/resources/classificationreports/subzones/index.html>) (you may ignore variant/subzone) in Table 10.3. You can move the transparency slider at the top of the map to intensify the colour of the BEC zone.



(<https://pressbooks.bccampus.ca/geoglabmanualv2/wp-content/uploads/sites/1340/2021/03/figure-9.3c-climate-bc-website.png>)

Figure 10.8. Step 3: BEC zone legend on the Climate BC website. Source: University of British Columbia. Used with permission. [Click to view image full size]

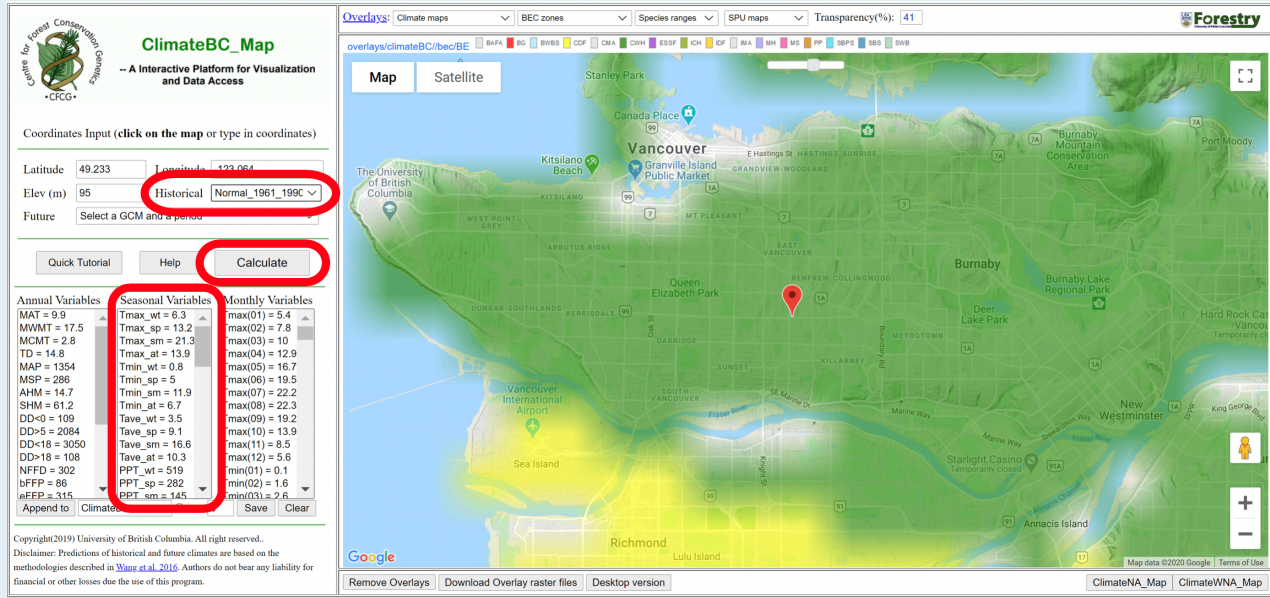
Step 4: Determine the climate variables for each site of interest. Having entered the correct coordinates, manually repositioned the cursor, and re-calculated, check the time period displayed in the **Historical** box (Figure 10.9). The default is **Normal_1961_1990**, which is adequate for our purposes. If you choose a more recent period (e.g., **Normal 1981-2010**; **Decade 2001-2010**), temperatures will have increased marginally due to anthropogenic climate change. However, soil formation reflects long term averages occurring over hundreds to thousands of years, so we can safely use the default period.

Click **Calculate**. Important note: you must click **Calculate** every time you change any settings in the left sidebar or on the map!

Under **Seasonal Variables** (Figure 10.9), find the following data for your site:

- Mean Winter Temperature (Tave_wt=) (shown in degrees Celsius)
- Mean Summer Temperature (Tave_sm=)
- Winter Precipitation (PPT_wt=) (shown in millimetres)
- Summer Precipitation (PPT_sm=).

Enter these data in the blank cells in your Table 10.3.



(<https://pressbooks.bccampus.ca/geoglabmanualv2/wp-content/uploads/sites/1340/2021/03/Figure-9.3d-Climate-BC-Website.png>)

Figure 10.9. Step 4: Determining climate variables. Source: University of British Columbia. Used with permission. [Click to view image full size]

3. In one to two sentences per site, address the following issues for each of the five sites examined:
 - a. The seasonal temperature and precipitation conditions. Rather than repeating the data in Table 10.3, simply indicate which sites are seasonally wettest and driest, warmest and coldest, etc.
 - b. How the local climate relates to the site's geographic location in terms of distance inland from the coast (i.e., is it coastal or interior) and elevation.
 - c. The types of vegetation (according to BEC zone or information from the Google Earth Tour) at the sites.
 - d. The relationships between BEC zone/vegetation and climatic conditions.

Note: You can determine approximate distance inland from the coast with the measurement tool in the Google Earth (Web) tour (<https://earth.google.com/earth/rpc/cc/drive?state=%7B%22ids%22%3A%5B%22182UkzVXoWuQxJF1X9NAXhDGIUZb2M4Q6%22%5D%2C%22action%22%3A%22open%22%2C%22userId%22%3A%22116924788817130860855%22%7D&usp=sharing>). Click the ruler icon on the left sidebar below the **Projects** button, position your cursor over your starting point (i.e., the coast) and click; then move the cursor inland, due east, to the site of interest and click again to find the straight-line distance between the points.

- Select another location of your own choice in extreme northern BC, above 58 degrees north latitude, by placing your cursor at your chosen spot and clicking to place a marker. Note whether this is a coastal or inland location. Click **Calculate** to update the climate data. Create a new row in your Table 10.3 and enter the site's geographic coordinates, BEC zone, and climate data as you did for the other sites. You will come back to this site, so you may want to keep this page open with your marker showing.

EX2: Describe the Soil Profiles

Now that we have examined the geography, climate variables, and BEC zones for the sites, we will examine representative soil profiles for each. Because we do not have available soil pits for our five sites, we will substitute equivalent profiles from UBC's Virtual Soil Monoliths website (<https://monoliths.soilweb.ca/>) (Krzic et al., 2010). A representative soil profile for each site has been selected for you from this collection. This exercise should take 45 minutes to complete.

5. Table 10.4 records soil profile characteristics of representative soil monoliths for our five sites. Some values have been pre-filled. Supply the missing values following the instructions below.

Table 10.4. Soil profile characteristics of soil monoliths representative of each site obtained from equivalent soil profiles. All depths are in centimetres (cm).

Information	Bog soil	Coastal needleleaf forest soil	Subalpine forest soil	Alpine tundra soil	Interior grassland, scrubland soil
Soil Monolith (label and link)	UBC # 6-01 (https://monoliths.soilweb.ca/6-01/)	UBC # 7-05 (https://monoliths.soilweb.ca/7-05/)	UBC # 1-20 (https://monoliths.soilweb.ca/1-20/)	UBC # 8-02 (https://monoliths.soilweb.ca/8-02/)	UBC # 2-06 (https://monoliths.soilweb.ca/2-06/)
Organic/litter layer (depth)	Om (0-13 cm) Oh (13-42 cm)			– not present	– not indicated
A horizon (depth)	– not present			Ah (0-5 cm)	
B horizon (depth)	– not present			– not present	
C horizon (depth)	IIC (42-78 cm)	IIC (27-57 cm) IIIC (57-100 cm)		C (5-59 cm)	
Parent Material	Lacustrine			Colluvium	
Descriptive Notes			Dark A layer from with visibly undecayed litter; Large pore, roots at 40 cm in Bm layer; Sub-rounded stones frequent below 70 cm; Transitions from A to B; B to C clear; A layers are separated by broken transition		
Soil Order	Organic		Brunisol	Regosol	
Soil Great Group	Humisol		Dystric Brunisol	Regosol	

Step 1: Download the Table 10.4 file to your computer from Worksheets and open it in a word-processing application.

Step 2: Follow the links in Table 10.4 to view the **soil monoliths** representative of soils at each site. For each monolith, you will find information about the soil including the **order**, **great group**, and **horizon** labels and associated depths for different layers of the soil that were identified by UBC soil scientists. To view 3D models of each monolith, follow the prompt beneath the title **To explore a 3D model of this monolith**, please click [here](#) and explore!

Step 3: Supply the missing information in Table 10.4 for each soil including **organic layer** label and depth; **A**, **B** and **C horizon** labels and depth, if applicable; **parent material** type; **soil order** and **great group** name. Some information has been pre-filled for you.

Step 4: On the soil monolith pages, click the bottom of the soil and then click again on the figure (+ symbol) to enlarge. Examine the image to expand upon the information about each soil. Look for characteristics such as:

- Obvious visible features such as strong colours (e.g., black indicates presence of organic matter; reddish/orange indicate presence of iron oxides).
- Mottles (visible blotches on the face of the profile – though these are not particularly evident in these dry monoliths).
- Large fragments, stones or boulders, and their frequency and shape.
- Distinctness and form of the lower boundary of each mineral horizon (A, B, if present). Use the terminology and diagrams in the Field Description of Soils that best correspond with what you see in the image (e.g., gradual/abrupt; smooth/wavy).
- Other properties to which you may wish to refer later, such as the thickness of the A or B horizon; lowercase suffix labels indicative of important properties, etc.

Enter your observations in point form in the Descriptive Notes row of Table 10.4 (see the pre-filled cell for an example). Your notes need not be exhaustive, but should simply highlight notable visible features, e.g., general colours, texture, presence of stones/rocks, mottles (choose 2-4 features for each soil).

Note: It is recommended that you take screenshots, or save the monolith photos to your desktop (right click on the enlarged image/press your computer trackpad with two fingers, click Save Image As, and save it to your computer as a .jpg file) to use in EX3.

EX3: Explore Soil Profile Characteristics and Underlying Processes

In this exercise you will apply and extend the knowledge acquired in the preceding exercises to explore soil profile characteristics and underlying processes in different contexts. It should take you 20 minutes to answer these questions.

6. Figure 10.10 shows an Organic soil from British Columbia. Possible horizon labels have been indicated, but these are tentative, based on the information provided in the image. Compare this soil with the one listed for Site #1 (horizon layers and its monolith at 6-01 TerricHumisol (<https://monoliths.soilweb.ca/6-01>)) and answer the following in 2-3 sentences:
 - a. Comment briefly on similarities (or differences, if present) between the profiles.
 - b. Explain why both these soils have no A or B horizons.

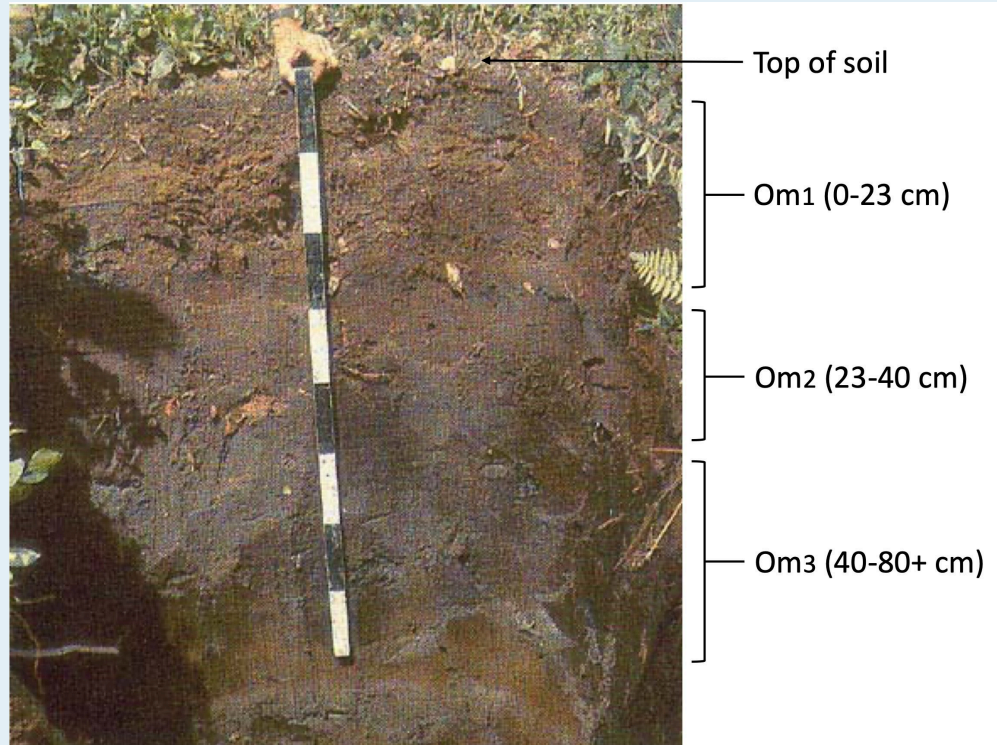


Figure 10.10. Soil pit in an Organic soil from BC (great group: Mesisol). The measuring stick is divided into 10 cm units. Note that the sub-horizon label **m** has a different meaning when used in combination with the Organic layer than with mineral (A, B or C) horizons, and is short for **mesic material**. See CSSC, Chap 2, Organic Horizons, Om. Source: Soil Working Group (Government of Canada). Used under Government of Canada terms and conditions. [Image description]

7. Figure 10.11 is an image of a podzol from Quebec. Drawing on information learned in lecture, this lab and your text, suggest appropriate names for the following layers, including major horizon and lowercase suffixes, and describe the processes responsible.
- The light-coloured layer at 4-7 cm: _____. Specific process(es) responsible (1-2 sentences).
 - The reddish/orange layer at 10-20 cm: _____. Specific process(es) responsible (1-2 sentences).

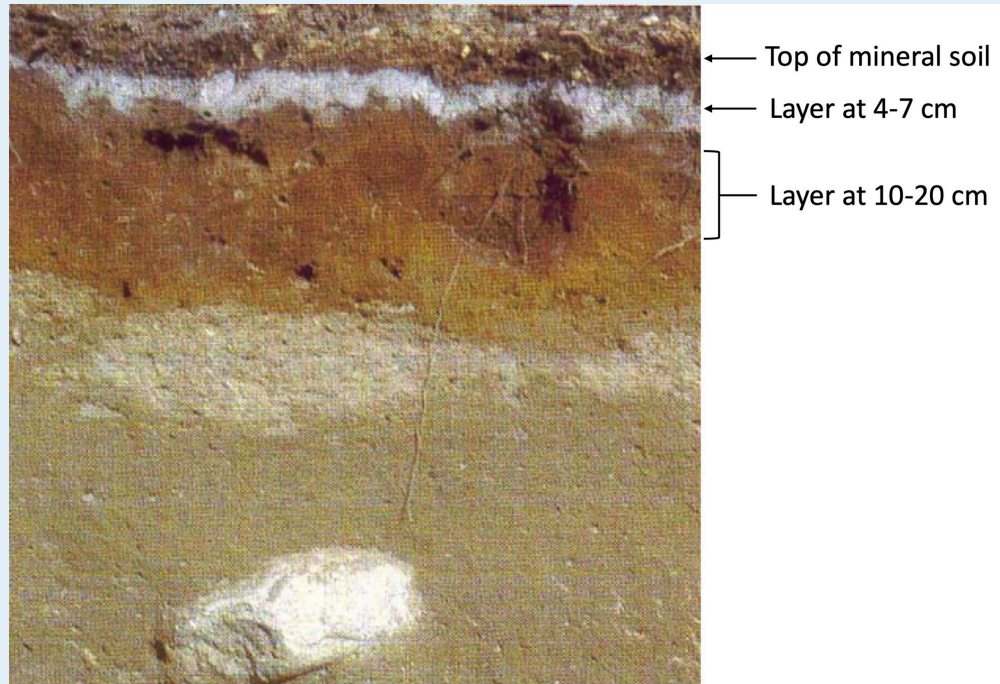


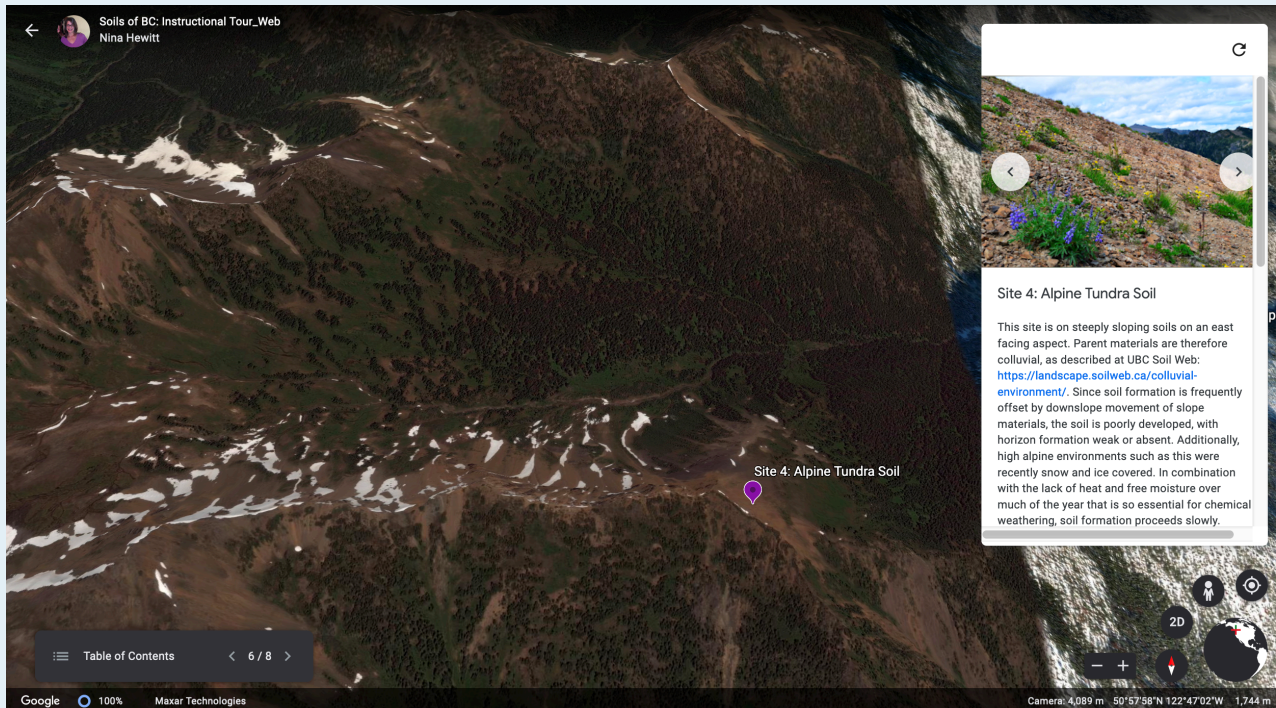
Figure 10.11. Podzolic soil from Quebec on sandy parent materials. Source: Soil Working Group (Government of Canada). Used under Government of Canada terms and conditions. [Image description]

8. Explain why you might expect to see evidence of gleying (mottles, blue-grey colours) about 2 feet below the soil surface at Site #2 in Malcolm Knapp UBC Research Forest (1-2 sentences). **Hint:** Consider the parent materials at this site, as discussed in these videos filmed on site at the Malcolm Knapp Research Forest:
 - Podzol on Glacial Till and Outwash Sediments – Youtube video (<https://youtu.be/kII44FHCO4k>) from the Google Earth tour (Video transcript: [Word] (<https://pressbooks.bccampus.ca/geoglabmanualv2/wp-content/uploads/sites/1340/2020/07/Lab-10-Video-Podzol-on-Glacial-Till-Transcript.docx>) [ODT] (<https://pressbooks.bccampus.ca/geoglabmanualv2/wp-content/uploads/sites/1340/2020/07/Lab-10-Video-Podzol-on-Glacial-Till-Transcript.odt>) [PDF] (<https://pressbooks.bccampus.ca/geoglabmanualv2/wp-content/uploads/sites/1340/2020/07/Lab-10-Video-Podzol-on-Glacial-Till-Transcript.pdf>)); and
 - The Podzolic Order – Youtube video (<https://youtu.be/rjGEbYy2sbc>) (also in the pre-reading Soli Classification).
9. Using their monoliths and your descriptions in Table 10.4, compare the soil profiles at Site #2, Malcolm Knapp forest and Site #3, Subalpine forest in 2-4 sentences. Specifically,
 - a. Note any differences in the A and B horizon properties (thickness, colour, features evident from the sub-horizon labels). You may wish to define the **Bm horizon**, a diagnostic (distinguishing) horizon in Brunisols such as the Site #3 soil.
 - b. Given that both sites have coniferous vegetation, account for the differences between them.

10. The Regosol at Site #4 (Alpine tundra) is hardly a soil. Just below, in the valley to the northwest, is a lush meadow (Figure 10.12; and you may wish to view Alpine Meadow ChilMts – Youtube video (<https://youtu.be/xq296w2g45s>)). This meadow is also located in the alpine zone. A possible alpine meadow soil profile for an alpine meadow is shown in Figure 10.13.

How would you expect the soil in Figure 10.8 to differ from the Regosol at Site #4? Specifically, describe **two** characteristics that might differ and briefly explain what about the meadow site might account for these differences relative to the scree slope soil (2-3 sentences).

Hint: The information panel in Site #4 of the Google Earth Instructional Tour suggested that you **Read more about the soils associated with this BEC zone unit at Selkirk College – BEC System in BC – Alpine Tundra** (<https://selkirk.ca/discover/bec/zones/AT.html>). See the 4th paragraph in the Introduction.



(<https://pressbooks.bccampus.ca/geoglabmanualv2/wp-content/uploads/sites/1340/2021/03/Figure-9.7-Google-Earth-Web-Tour-at-Site-4.png>)

Figure 10.12. Screenshot of Google Earth tour at Site #4 location. Screenshot by N. Hewitt. Used in accordance with Google Earth terms and conditions. [Click to view image full size]



(<https://pressbooks.bccampus.ca/geoglabmanualv2/wp-content/uploads/sites/1032/2020/07/Figure-9.8-Soil-pit-in-a-Brunisol-soil-sombri-brunisol-from-an-alpine-meadow.jpg>)

Figure 10.13. Soil pit in a Brunisol soil (sombri brunisol) from an alpine meadow. Photo courtesy of Canadian Society of Soil Science (2020), licensed as CC BY-NC 4.0.

11. For the northern BC location you chose in Q4, predict the sort of soil you might expect to find. Pay attention to climate, BEC zone, and soil formation processes. Suggest an appropriate order and indicate why you chose it. **Note:** It may be a soil order you have not yet described, so use your text or other resources to help you name and describe it.

Describe your findings in one paragraph stating the soil order, the soil's major characteristics and why you would expect the soil here to fall into this order.

Reflection Questions

1. In EX1 we examined the vegetation types at each site and explored how climate parameters were associated with BEC Zone. However, the vegetation at Site #1 (Burns Bog) did not relate clearly to its climate or BEC zone. Briefly explain why this would be, and the implications for the soils

found there. (1-2 sentences).

BONUS: At Site #1 (the bog soil) imagine that you dug down to layers deposited 7,000-8,000 years ago and found a mysterious layer of fine mineral material. How might you account for that?

Hint: This layer was deposited on top of the soil; watch the first nine minutes of this video of Kent Watson (Thompson Rivers U) and Dr. Art Bomke (UBC Land and Food Systems) interpreting an organic soil along the Coquihalla Highway (<https://youtu.be/YJkoUXUTSGU>) just north of Merritt, BC. (1-2 sentences).

2. The Podzolic soil order has over 50 different soil monoliths in the UBC Soilweb (<https://monoliths.soilweb.ca/>), more than any other soil order. View this distribution map of the Podzols [JPG] (https://soilsofcanada.ca/images/podzolic_map.jpg#View%20map) in Canada to appreciate why. Provide **two** reasons to explain why Podzols are so common in BC (2-3 sentences).
3. The BEC zone identified for Site #5 (Similkameen River environs) occurs in close proximity to two contrasting BEC zones. Find these zones by returning to our Site #5 location on the BEC zone map on the ClimateBC_Map website (http://www.climatewna.com/ClimateBC_Map.aspx), and do the following:
 - a. Choose and name one of them (just major zone label).
 - b. Suggest the type of soil (by order name) you might expect it to be associated with.
 - c. Indicate how it might differ from the soil at Site #5 (identify one main difference that refers to the characteristics of the soil profile itself, e.g., depth, color of A horizon, presence of particular sub-horizon layers, etc.).

Refer to information in Selkirk College – BEC System in BC – Alpine Tundra (<https://selkirk.ca/discover/bec/zones/AT.html>) and perhaps view sample monoliths of your chosen soil order at UBC Soilweb (<https://monoliths.soilweb.ca/>) to assist you.

Worksheets

Lab 10 Table 10.3

Back to EX2

- Lab 10 Table 10.3 [Word] (<https://pressbooks.bccampus.ca/geoglabmanualv2/wp-content/uploads/sites/1340/2020/07/Lab-10-Table-10.3.docx>)
- Lab 10 Table 10.3 [ODT] (<https://pressbooks.bccampus.ca/geoglabmanualv2/wp-content/uploads/sites/1340/2020/07/Lab-10-Table-10.3.odt>)
- Lab 10 Table 10.3 [PDF] (<https://pressbooks.bccampus.ca/geoglabmanualv2/wp-content/uploads/sites/1340/2020/07/Lab-10-Table-10.3.pdf>)

Lab 10 Table 10.4

Back to EX3

- Lab 10 Table 10.4 [Word] (<https://pressbooks.bccampus.ca/geoglabmanualv2/wp-content/uploads/sites/1340/2020/07/Lab-10-Table-10.4.docx>)
- Lab 10 Table 10.4 [ODT] (<https://pressbooks.bccampus.ca/geoglabmanualv2/wp-content/uploads/sites/1340/2020/07/Lab-10-Table-10.4.odt>)
- Lab 10 Table 10.4 [PDF] (<https://pressbooks.bccampus.ca/geoglabmanualv2/wp-content/uploads/sites/1340/2020/07/Lab-10-Table-10.4.pdf>)

References

Canadian Society of Soil Science. (2020). Soils of Canada. <https://soilsofcanada.ca/>

Krzić M., R. Strivelli, E. Holmes, and S. Dyanatkar. (2010). *Virtual soil monolith collection at UBC*. The University of British Columbia, Vancouver. <https://monoliths.soilweb.ca/>

Selkirk College. (2004). Biogeoclimatic ecosystem classification system in British Columbia. <https://selkirk.ca/discover/bec/zones/zones.html>

Soil Classification Working Group. (1998). *The Canadian system of soil classification, 3rd edition*. Government of Canada. <http://sis.agr.gc.ca/cansis/taxa/cssc3/index.html>

University of British Columbia. (2019). *ClimateBC Map*. http://www.climatewna.com/ClimateBC_Map.aspx

Image Description

Figure 10.1. Diagram of a soil profile

Figure 10.1 is a schematic diagram showing the approximate positions of the major soil horizons within an example soil. From the ground surface (0 cm) downwards, the soil horizons are:

The O horizon is the very top of the soil and is made up of organic material. The size of the O horizon varies depending on the amount of organic matter present, and is sometimes absent.

The A horizon is the top mineral layer of soil. This layer is often the darkest mineral layer and typically has more plant roots and biological activity. In this example, the A horizon is found directly below the O horizon, to a depth of approximately 15 cm.

The B horizon is the middle mineral layer of soil, and although there are some plant roots and biological activity, there are less minerals present to support this activity. In this example the B horizon is found between the approximate depths of 15 cm and 45 cm.

The C horizon is the bottom mineral layer of soil, and is the parent material which the soil developed from. In this example, the C horizon is found between the approximate depths of 45 cm and 75 cm.

[Return to Figure 10.1]

Figure 10.10 Soil pit in an Organic soil from BC

A photograph of an organic mesisol soil pit from BC. It has three organic layers, Om1, Om2, and Om3. The lowercase m denotes “mesic material”, meaning that these are organic layers with mesic materials. In this photograph... Om1 is from 0 to 23 cm in depth, and is a lighter brown colour. Om2 is from 23 to 40 cm in depth, and is a darker brown colour. Om3 is from 40 to 80+ cm in depth, is a darker brown colour, and appears to be more saturated with water.

[Return to Figure 10.10]

Figure 10.11 Podzolic soil from Quebec on sandy parent materials

A photograph of a podzol soil pit from Quebec. It has three layers on top of a sandy parent material. The top of the mineral soil has an approximate depth of 4 cm, is brown in colour, and has visible plant roots. The second layer is from the approximate depth of 4 to 7 cm and is white. The third layer is from 10 to 20 cm in depth and is a pale brown colour. Below the third layer, is the sandy parent material.

[Return to Figure 10.11]

Lab 11: Environmental Controls on Biogeography

Gillian Krezoski

Biogeography is the science that attempts to document and understand spatial patterns in biodiversity. There are many **biotic** (living) factors that determine where **biotas** (e.g., assemblages of plants, animals) live, including competition and predation, as well as **abiotic** (environmental) conditions like fire and soil type. In this lab we will examine two major abiotic conditions that have a strong impact on what type of plant and animal species live where, worldwide: climate and topography. Species adapt and survive based on these factors or die out if challenges created by these conditions become too hard to overcome.

In this lab you will examine the geographic distribution of nine oak (*Quercus*) species in North America. Oaks all produce acorns, and are grouped into two general categories based on leaf shapes (amongst other things): lobed oak species are considered members of the **white oak** group, whereas serrated (pointy) leaf shapes are considered **black oak** group members. There are at least 90 species of oaks in North America, alone. Each have developed traits to ensure successful survival in differing abiotic conditions within their local environments. Based on your findings, you will answer several discussion questions designed to draw a link between environmental conditions and oak species adaptations to living in those areas.

Learning Objectives

After completion of this lab, you will be able to

- Collate observations and conclusions from several datasets.
- Begin to understand how climate and topography create different biogeographic zones.
- Analyze spatial data to determine abiotic impacts on oak tree diversity in North America.

Pre-Readings

In order to complete this lab, some background information on biogeography, *Quercus* species and climate maps are required. The United States Department of Agriculture has a comprehensive handbook covering multiple species, including *Quercus*. You will see portions of this text in this lab, and it can be explored further in *Silvics of North America, Volume 2* (https://www.srs.fs.usda.gov/pubs/misc/ag_654/volume_2/vol2_table_of_contents.htm) (scroll to *Quercus*).

Abiotic Factors and How They Can Impact Tree Growth

Abiotic factors are non-living components of the environment that influence how and where organisms populate. These factors include components such as precipitation, sunlight and temperature (latitude), topography (altitude), nutrients and soils.

A good summary of how abiotic factors influence deciduous versus evergreen trees can be found in Smith (1993) (<https://www.jstor.org/stable/pdf/3858181.pdf>). Read this article or the summary provided by your instructor.

Water

Water is a fundamental abiotic factor regulating life as we know it on Earth. Plants need water to grow – even in deserts. Plant growth habits can be impacted by abundance of water, nutrients and sunlight, with areas that receive more of each often seeing taller plant growth.

Sunlight and Temperature

The sun drives the Earth's climate. The sun is a major source of energy and thus also the primary driver of life on Earth. The sun provides energy to heat the planet (thus making the planet habitable) as well as the energy source used for photosynthesis by the base of our planet's food chain. The sun's energy heats the atmosphere, creating winds, influencing evaporation and precipitation, and driving atmospheric circulation. Climate is an important long-term environmental factor to which species adapt and is often categorized using temperature and precipitation.

Depending on where a plant is living in the world, adaptations can differ. For example, in areas where the sunlight is strong and drives much evapotranspiration, plants have adapted to have small to no leaves in order to conserve water (e.g. cacti). Often leaves have a waxy coating that also prevent water loss.

In areas that are more temperate (temperatures are more moderate and there is more precipitation), leaves are larger to take advantage of the limited but bountiful photosynthetic environment. Often temperate locations are at a higher latitude and there is a portion of the year with much less sunlight (e.g. winter), where photosynthesis takes too much energy out of plant metabolism. In these places, trees lose their leaves seasonally (deciduous) and go dormant, conserving their energy and water for sunnier times. In areas where trees experience little to no seasonal fluctuations due to a mild climate and consistent rainfall, or where they experience harsh survival conditions and cannot spare the energy to regrow new leaves every year, trees remain evergreen (e.g. conifers) (Smith, 1993).

Most oak species are known for their lobe or serrated leaf shapes. The shape is often controlled by sunlight and precipitation – oaks that receive **too much** sunlight and less precipitation can minimize their gas exchange areas and narrow their margins to conserve water, versus areas that receive ideal sunlight and precipitation – leaves can be larger, wider and can support abundant gas exchange.

Oak species are relatively shade-intolerant (meaning they prefer full sunlight conditions) hardwoods. Often they rely on fire to eliminate competition from more shade-tolerant species. Studies on the history of humans and oak species over thousands of years can be explored further (outside of this lab)

in Pellat and Gedalof (2014). (https://www.researchgate.net/publication/261914053_Environmental_change_in_Garry_oak_Quercus_garryana_ecosystems_The_evolution_of_an_eco-cultural_landscape)

Topographic Conditions

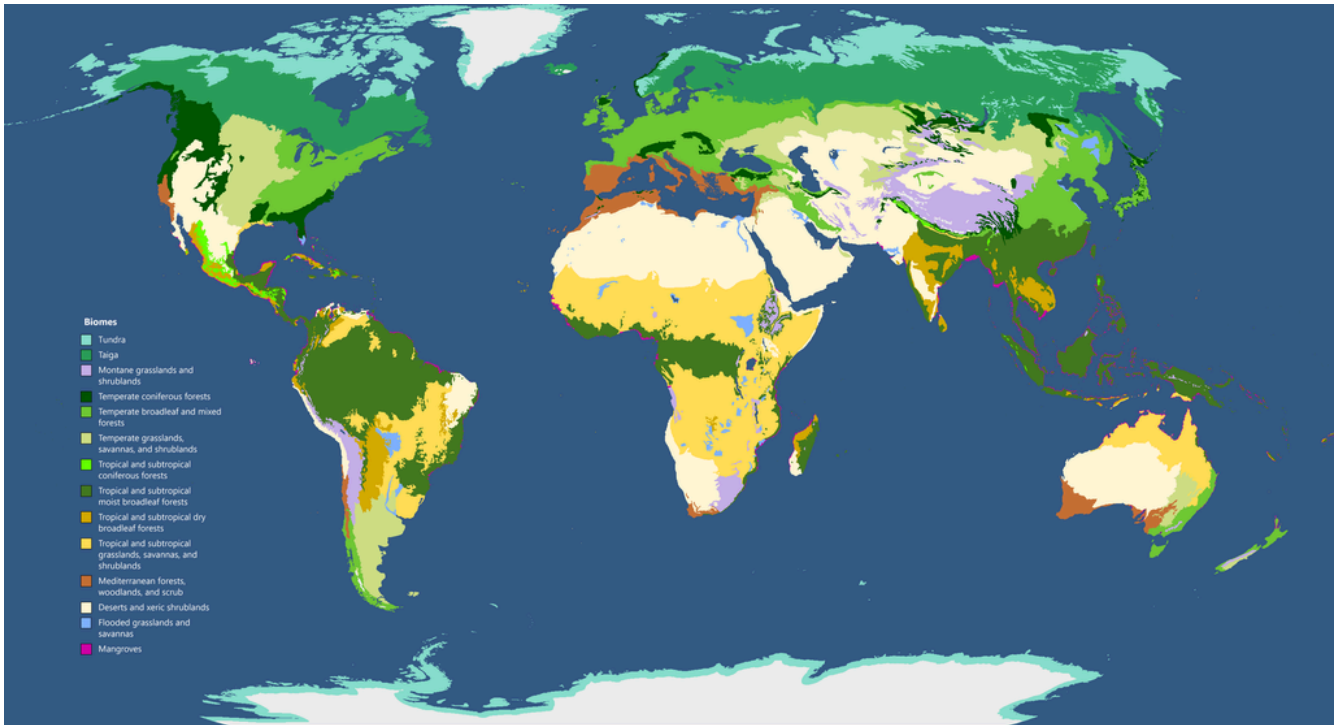
Also known as surface roughness, topography can also impact climatic conditions. Higher elevations, are colder due to lower atmospheric pressure and gas concentrations (**thinner air**) at higher elevation, where heat cannot be trapped as easily. Species living in higher versus lower elevations must be adapted to lower temperatures, prolonged freezing, and potentially lower oxygen levels from low atmospheric pressures at higher elevations, as well as poorer soil and nutrient cycling. Mountains also create orographic lift and rain shadows, producing regionally wetter (windward-side) or drier (lee-side) climate conditions.

Soils and Nutrients

Soils themselves provide basic vitamins and minerals for plant life to survive and thrive. Soils differ from place to place, based on parent rock, climate (temperature and precipitation) and organic decomposition rates. Carbon dioxide (CO₂) is an important component of the photosynthesis process for plants, with Oxygen (O₂) being a byproduct.

Biomes and Global Climate Zones

The world is divided into biomes, characterized by abiotic conditions that support particular habitats (Figure 11.1).



(<https://pressbooks.bccampus.ca/geoglabmanualv2/wp-content/uploads/sites/1340/2021/06/figure-1-lab-11.png>)

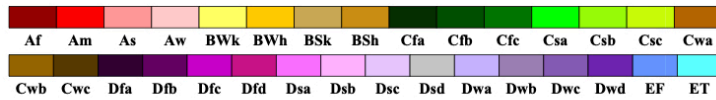
Figure 11.1. *Biomes of the world.* Source: *Biomes of the World – Retouched* (https://upload.wikimedia.org/wikipedia/commons/e/ea/Biomes_of_the_World_-_Retouched.png) by *Terpsichores*, CC BY-SA 3.0 [Image description] [Click to view image full size]

For more information on biomes, visit the online exhibit of Earth’s biomes at the University of California Museum of Paleontology (<https://ucmp.berkeley.edu/exhibits/biomes/index.php>).

Temperature and precipitation strongly impact types and adaptations of vegetation (as discussed in Abiotic Factors above). One common way of examining worldwide climate zones is the Köppen-Geiger method, which looks at Climate Normals (30 years of data) and assigns codes that represent common climate variables (Figure 11.2).

World Map of Köppen–Geiger Climate Classification

updated with CRU TS 2.1 temperature and VASCLimO v1.1 precipitation data 1951 to 2000



Main climates

- A: equatorial
- B: arid
- C: warm temperate
- D: snow
- E: polar

Precipitation

- W: desert
- S: steppe
- f: fully humid
- s: summer dry
- w: winter dry
- m: monsoonal

Temperature

- h: hot arid
- k: cold arid
- a: hot summer
- b: warm summer
- c: cool summer
- d: extremely continental
- F: polar frost
- T: polar tundra

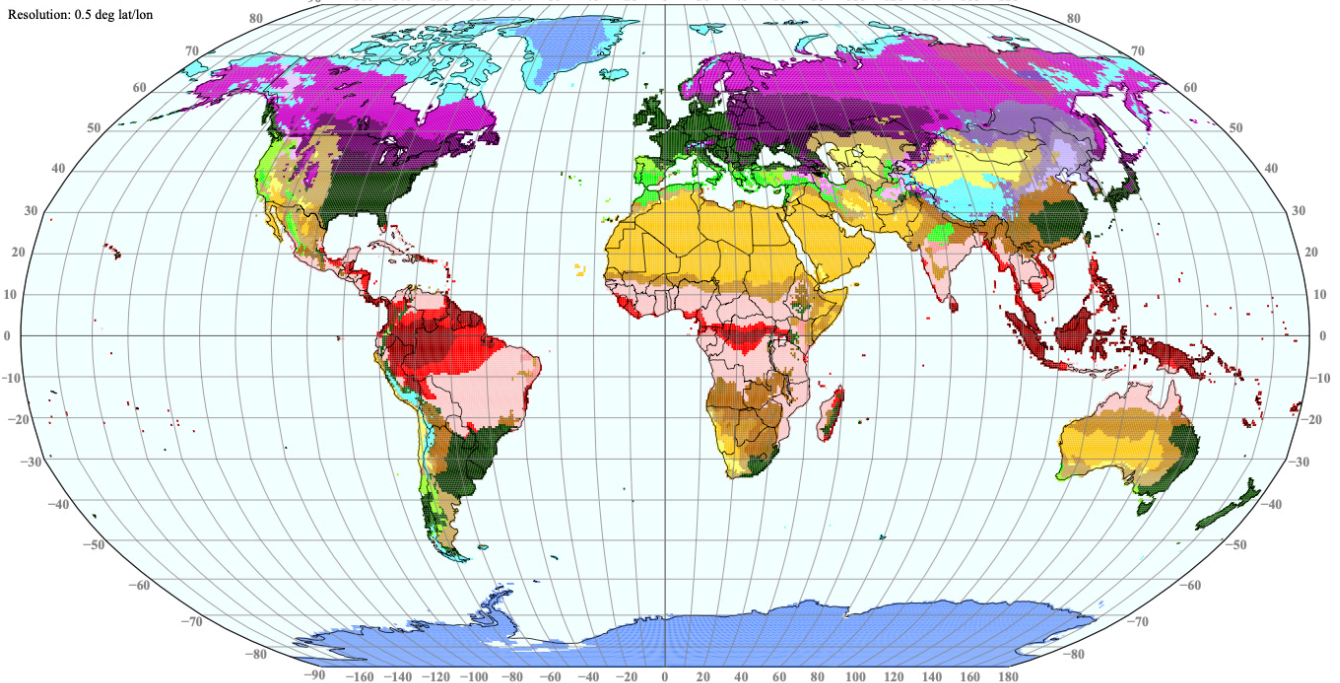


Figure 11.2. World Map of the Köppen–Geiger climate classification (updated). Refer to Appendix A for details on the derivation of climates and an explanation of climate codes. Source: Kottek, M., J. Grieser, C. Beck, B. Rudolf, and F. Rubel, 2006: World Map of the Köppen–Geiger climate classification updated [PDF]. (http://kooppen-geiger.vu-wien.ac.at/pdf/Paper_2006.pdf) Meteorol. Z., 15, 259-263. [Click to view image full size]

Compare Figure 11.1 and Figure 11.2, and observe that the world’s biomes and climate zones closely correlate. If you would like to explore the Köppen–Geiger system further, see this Resource Library entry from National Geographic introducing the classification system: Köppen Climate Classification System (<https://www.nationalgeographic.org/encyclopedia/koppen-climate-classification-system/>).

Lab Exercises

In this lab you will examine the growth habits and leaf characteristics of nine North American Oak species, and link species distribution across North America to climate and topography.

This lab includes two exercises that result in creating an assignment to be handed in as a report in PDF format. The submitted report will include a series of tables and figures with captions, and text, and should be approximately 5-6 pages long. External references must be cited. The entire lab will take approximately 2 hours to complete.

In EX1 you will use a number of sources to create a summary table and distribution map of nine North

American oak species. In EX2 you will explore links between the distribution of species and abiotic factors at the group level.

EX1: Creating a Summary Table and Distribution Map of North American Oak Species

Step 1: Identify Species Characteristics (Table 11.1)

The nine oak species you will investigate in this exercise are listed in Table 11.1 in Worksheets. Open Table 11.1 on your computer or shared drive as directed by your instructor. The table contains links to summary sheets for each oak species. Click on the species names to access.

Use these linked plant fact sheets and the Appendix C to complete the species characteristics in Table 11.1.

Note each species is assigned a letter (A,B,C) and grouped based on geographic location.

Step 2: Identify Climate and Topography (Table 11.1)

Next, examine the distribution maps in Appendix C to see where each species is currently found. For each species, determine Köppen-Geiger climate code(s) from the map in Appendix A. Rainfall averages and annual temperatures can be found in the summary sheets (or via the Silvics of North America links in Table 11.2 in Appendix C). Interpret the general topography (e.g., mountainous vs lowland) from the map in Appendix B. You can also use this interactive viewer (<https://maps.ngdc.noaa.gov/viewers/grid-extract/index.html>) to zoom in on topography by choosing ETOPO1 bedrock dataset.

Record the climate code, average rainfall and temperature, and general topography for each species in Table 11.1.

Step 3: Map the Spatial Distribution of Selected *Quercus* Species in North America (Map 11.1)

Use the distribution maps in Appendix C to complete Map 11.1 (Worksheets).

Open Map 11.1 on your computer or shared drive as directed by your instructor. You may print out the map, draw your tick marks by hand, and scan/photograph, or use PowerPoint or Word to draw directly on the electronic image.

Place a **tick mark** within each **grid** box created by the 5 degrees (N-S) latitude and 10 degrees longitude (E-W) lines that cover the same area as each species to demonstrate distribution areas. Use a different colour for each **grouping** (A, B, C). For example, if your species covers areas of the west coast, put a tick mark in each box along the west coast as appropriate.

Create a legend for your map. Keep in mind that you will need one more colour to answer Reflection Q1, and this will also need to be added to the legend.

Scan, photograph, or save your map at this stage. An example Map 11.1 is found in Figure 11.3.

Step 4: Create the EX1 Portion of Your Report

Open a Word document on your computer, and create a title page for your lab report that includes the title of this lab assignment, your name, lab section, and date.

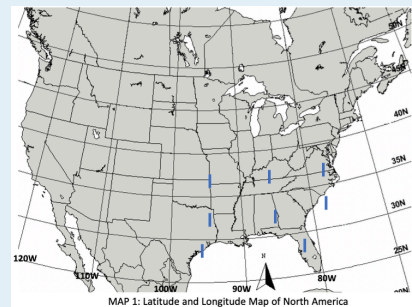


Figure 11.3. Example Map 11.1. Tick marks (blue) show the distribution of *Quercus lyrata* (overcup oak). Click on the image to enlarge it. Source: Base map by Journey North (<https://journeynorth.org/>), CC BY-NC-SA 3.0.

Create the Exercise 1 portion of your lab report by inserting the title **Exercise 1: Summary Table and Map** and insert:

- Table 11.1: Summary Characteristics of North American Oak Species.
- Map 11.1: Distribution of Selected *Quercus* Species in North America.

Add descriptive captions to each item to complete this portion of the report.

EX2: Linking Species Distribution and Abiotic Factors at the Group Level

Based on Map 11.1 and the groupings in Table 11.1 (A,B,C), briefly describe the grouping's general North American location and list which species are included. For each grouping, include information on

- Representative climate – the climate code and temperature and precipitation. If you have more than one representative climate type, describe what it is and why.
- Representative topography. If you have more than one representative topography, describe what it is and why.
- Species adaptations of tree/shrub characteristics (e.g., growth habit, height, evergreen versus deciduous, leaves) and critically think about some reasons you are seeing these types of species adaptations within a geographic area, based on their abiotic conditions (see Abiotic Factors).
- Other factors that could be important for each grouping's adaptations that we aren't considering in this lab. See Abiotic Factors for some ideas. As a geographer, how would you go about researching those links? What datasets would you look for?

Be sure to establish a link between climate, topography and species adaptations for full marks. Organize your discussion per grouping, with a subheading listing the group letter and general North American location before each summary. Limit each grouping summary to 300 words (approximately 2-3 paragraphs).

Create a new section of your lab report titled **EX2: Linking Species Distribution and Abiotic Factors at the Group Level** and type in your answers.

Reflection Questions

1. Choose one (1) additional *Quercus* species that has not been examined in this lab from *Silvics of North America, Volume 2* (https://www.srs.fs.usda.gov/pubs/misc/ag_654/volume_2/vol2_table_of_contents.htm) (scroll to *Quercus*).
 - a. State your species and why you chose it.
 - b. Add additional tick marks in a different colour for your species distribution on Map

11.1, and update your legend.

- c. Describe, in 1-2 paragraphs, the tree habit, height, leaf characteristics, climate and topography. Note that you might have to search on the web for additional information, like leaf characteristics. Be sure to include citations on any external sources you use.
 - d. Discuss, in 1-2 paragraphs, how abiotic conditions (temperature, precipitation and topography) could have influenced your tree's adaptations (height, leaf characteristics, etc). Assign your species to a group from the table above (A, B or C) based on their location and characteristics, or if you decide it should be a new category, explain why. Discuss how your chosen species is similar or different to the previously examined grouping(s) and speculate as to why.
 - e. Demonstrate critical thinking and your understanding of how abiotic conditions can influence tree growth.
2. As you examined fact sheets about oak species, you probably noticed unique vocabulary words in the descriptions. List and define five (5) new vocabulary words you encountered during this exercise.

Create a new section of your lab report titled **Reflection Questions** and type in your answers. Scan or photograph your revised Map 11.1 and include as you response to Q1b.

Report Submission

Once all exercises are complete, save the assignment as a PDF. Do a final check to make sure your maps are clear and that all external references are cited. Submit as directed by your instructor.

Worksheets

Return to EX1

Table 11.1 Summary Table

- Lab 11 Table 11.1 [Word] (<https://pressbooks.bccampus.ca/geoglabmanualv2/wp-content/uploads/sites/1340/2020/07/Table-11.1-Summary-Table.docx>)
- Lab 11 Table 11.1 [ODT] (<https://pressbooks.bccampus.ca/geoglabmanualv2/wp-content/uploads/sites/1340/2020/07/Table-11.1-Summary-Table.odt>)
- Lab 11 Table 11.1 [PDF] (<https://pressbooks.bccampus.ca/geoglabmanualv2/wp-content/uploads/sites/1340/2020/07/Table-11.1-Summary-Table.pdf>)

Map 11.1 Worksheet

- Lab 11 Map 11.1 Worksheet [Word] (<https://pressbooks.bccampus.ca/geoglabmanualv2/wp->

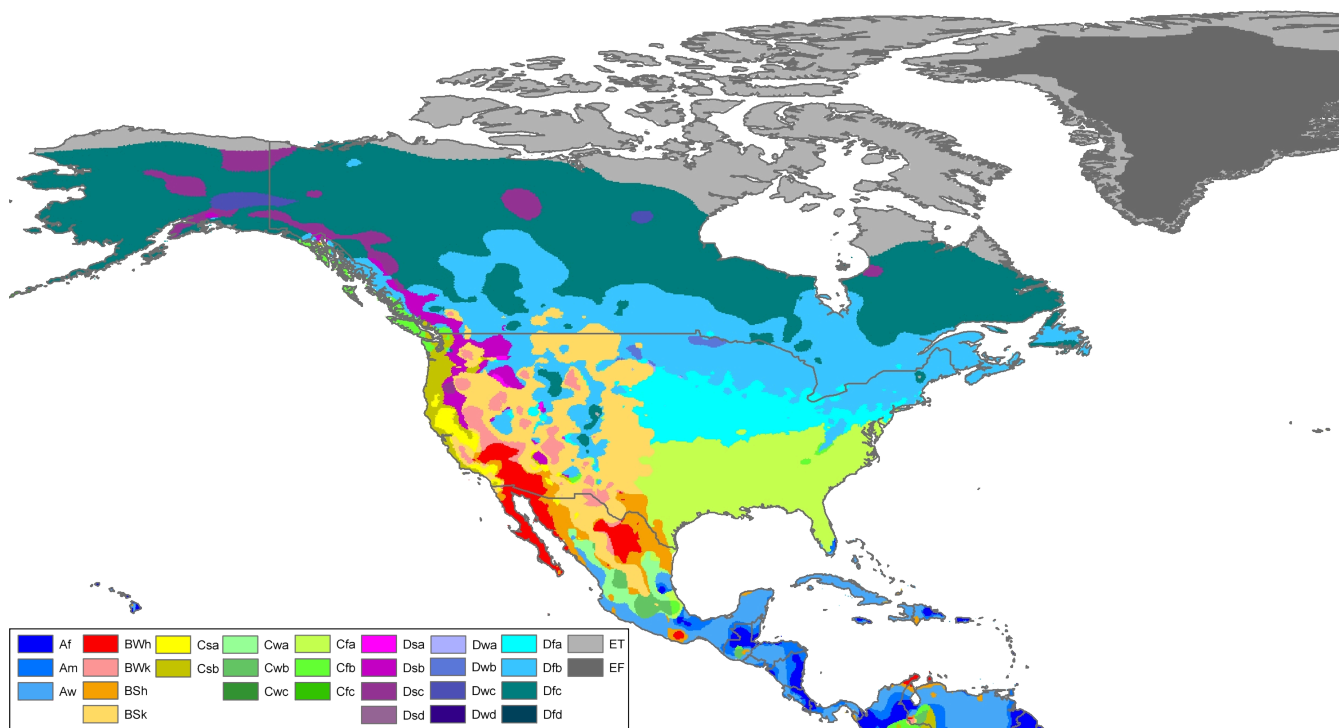
content/uploads/sites/1340/2020/07/Map-11.1-Worksheet.docx)

- Lab 11 Map 11.1 Worksheet [ODT] (<https://pressbooks.bccampus.ca/geoglabmanualv2/wp-content/uploads/sites/1340/2020/07/Map-11.1-Worksheet.odt>)
- Lab 11 Map 11.1 Worksheet [PDF] (<https://pressbooks.bccampus.ca/geoglabmanualv2/wp-content/uploads/sites/1340/2020/07/Map-11.1-Worksheet.pdf>)

Supporting Material

Appendix A: Köppen-Geiger Climate Map of North America

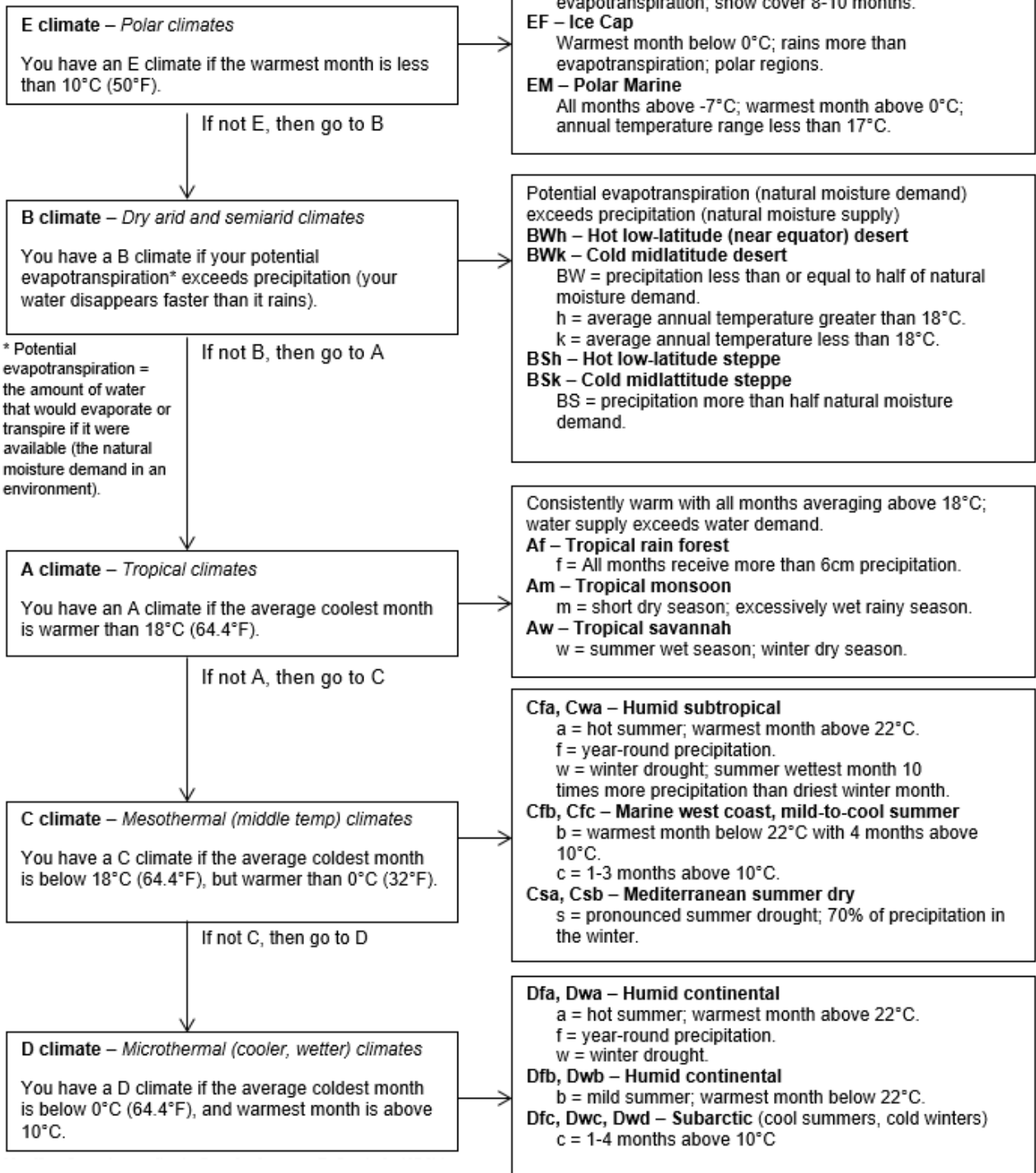
[Back to top](#)



(https://pressbooks.bccampus.ca/geoglabmanualv2/wp-content/uploads/sites/1032/2020/07/North_America_K%C3%B6ppen_Map.png)

Figure 11.4.a. View file in colour to determine climate zones. Codes for climate codes are provided in the legend. Descriptions for each code can be found in **Figure 11.4.b**. Source: Peel, Finlayson, & McMahon (2007) (<https://hess.copernicus.org/articles/11/1633/2007/>), CC BY-NC-SA. [Click to view image full size]

Determining primary Köppen-Geiger climate classification (E, B, A, C, D)

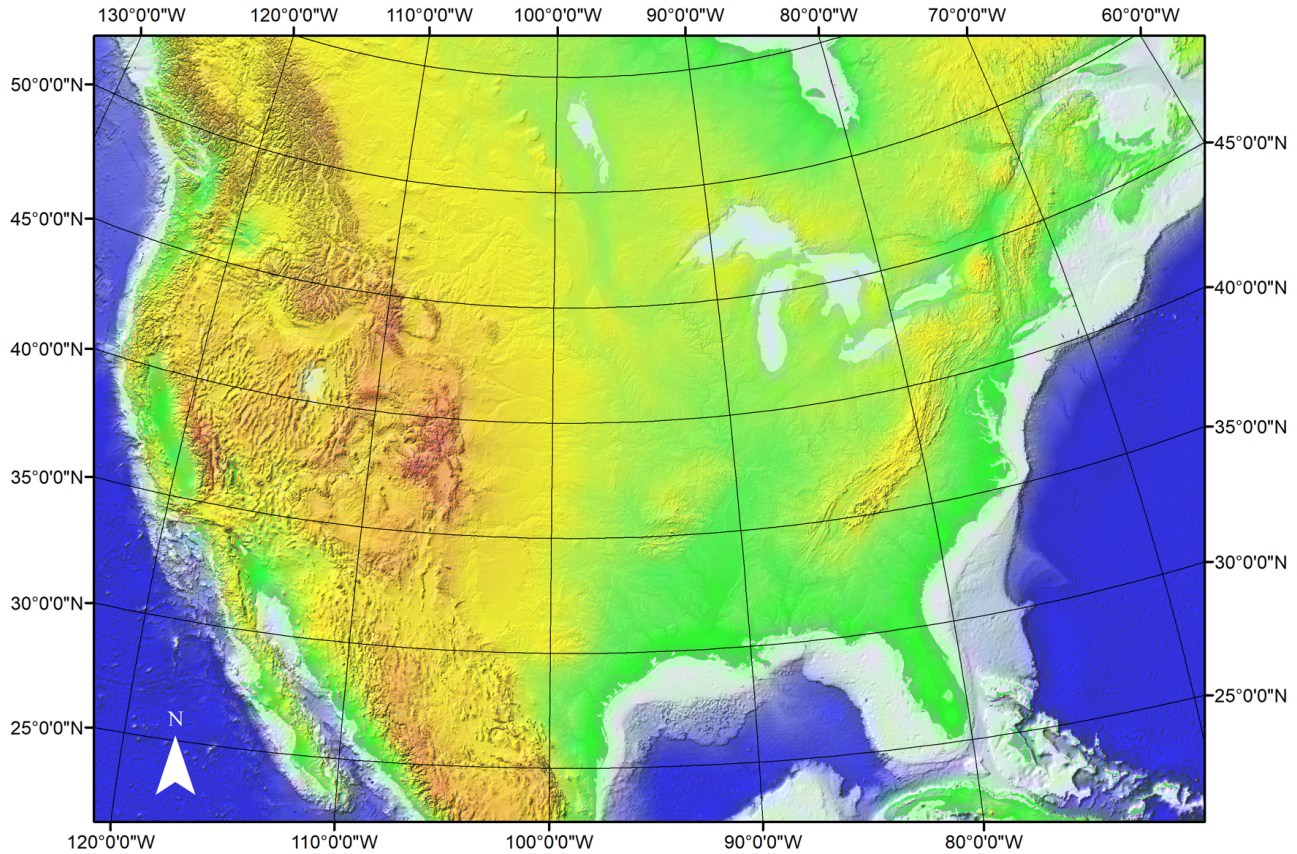


(<https://pressbooks.bccampus.ca/geoglabmanualv2/wp-content/uploads/sites/1340/2021/03/Determining-Primary-Koppen-Geiger-Climite-Class-Classification-E-B-A-C-D.png>)

Figure 11.4.b. Flow chart for determining Köppen-Geiger climate classification. Source: G. Krezoski adapted from Christopherson (2019) Appendix C. [Click to view image full size]

Appendix B: North American Topographic Map

Back to top



World Topography and Bathymetry (Data Source: ESRI, NOAA, NGDC (2020) <https://arcg.is/0jLr5H>)

(<https://pressbooks.bccampus.ca/geoglabmanualv2/wp-content/uploads/sites/1340/2020/07/figure-11.5-Topo-NA.png>)

Figure 11.5. Topographic map of North America. Red indicates high elevation and green indicates low elevation. Note that this map has the same scale and quadrants as Map 11.1. Source: S. Peirce, CC-BY 4.0. Data source: ESRI, NOAA, NGDC (2020), <http://arcg.is/0jLr5H>. [Click to view image full size]

Appendix C: North American Oak Species Characteristic Fact Sheets

Go back to EX1

Table 11.2. Resources for North American Oak Species.

Species	USDA NRCS Fact Sheet	Silvics of North America	Leaf Shape	Distribution Map
<i>Quercus bicolor</i>	QUBI [PDF] (https://pressbooks.bccampus.ca/geoglabmanualv2/wp-content/uploads/sites/1340/2021/03/Quercus_bicolor.pdf)	Swamp White Oak (https://www.srs.fs.usda.gov/pubs/misc/ag_654/volume_2/quercus/bicolor.htm)	Figure 11.6	Figure 11.7
<i>Quercus chrysolepis</i>	QUCH2 [PDF] (https://pressbooks.bccampus.ca/geoglabmanualv2/wp-content/uploads/sites/1340/2021/03/Quercus_chrysolepis.pdf)	Canyon Live Oak (https://www.srs.fs.usda.gov/pubs/misc/ag_654/volume_2/quercus/chrysolepis.htm)	Figure 11.8	Figure 11.9
<i>Quercus douglasii</i>	QUDO [PDF] (https://pressbooks.bccampus.ca/geoglabmanualv2/wp-content/uploads/sites/1340/2021/03/Quercus_douglasii.pdf)	Blue Oak (https://www.srs.fs.usda.gov/pubs/misc/ag_654/volume_2/quercus/douglasii.htm)	<i>Q douglasii</i> (http://www.efloras.org/florataxon.aspx?flora_id=1&taxon_id=233501022)	Figure 11.10
<i>Quercus garryana</i>	QUGA4 (https://www.sevenoaksnativenursery.com/native-plants/trees/quercus-garryana/)	Oregon White Oak (https://www.srs.fs.usda.gov/pubs/misc/ag_654/volume_2/quercus/garryana.htm)	Figure 11.11	Figure 11.12
<i>Quercus laurifolia</i>	QULA3 (http://sfrc.ufl.edu/extension/4h/trees/laurel_oak/index.html)	Laurel Oak (https://www.srs.fs.usda.gov/pubs/misc/ag_654/volume_2/quercus/laurifolia.htm)	Figure 11.13	Figure 11.14

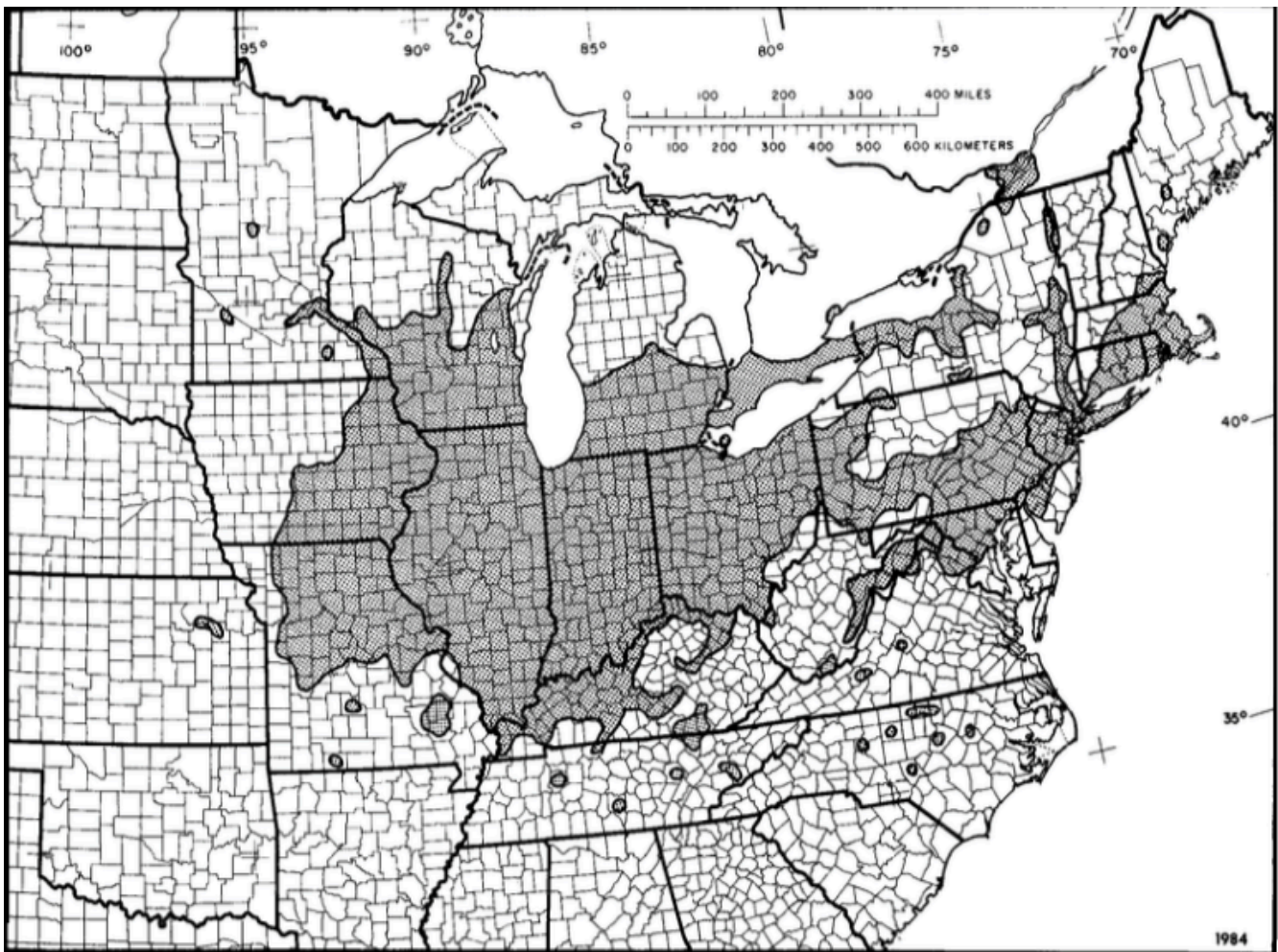
<i>Quercus macrocarpa</i>	QUMA2 [PDF] (https://pressbooks.bccampus.ca/geoglabmanualv2/wp-content/uploads/sites/1340/2021/03/Quercus_macrocarpa.pdf)	Bur Oak (https://www.srs.fs.usda.gov/pubs/misc/ag_654/volume_2/quercus_macrocarpa.htm)	Figure 11.15	Figure 11.16
<i>Quercus phellos</i>	QUPH [PDF] (https://pressbooks.bccampus.ca/geoglabmanualv2/wp-content/uploads/sites/1340/2021/03/Quercus_phellos.pdf)	Willow Oak (https://www.srs.fs.usda.gov/pubs/misc/ag_654/volume_2/quercus/phellos.htm)	Figure 11.17	Figure 11.18
<i>Quercus rubra</i>	QURU [PDF] (https://pressbooks.bccampus.ca/geoglabmanualv2/wp-content/uploads/sites/1340/2021/03/Quercus_rubra.pdf)	Northern Red Oak (https://www.srs.fs.usda.gov/pubs/misc/ag_654/volume_2/quercus/rubra.htm)	Figure 11.19	Figure 11.20
<i>Quercus virginiana</i>	QUVI [PDF] (https://pressbooks.bccampus.ca/geoglabmanualv2/wp-content/uploads/sites/1340/2021/03/Quercus_virginiana.pdf)	Live Oak (https://www.srs.fs.usda.gov/pubs/misc/ag_654/volume_2/quercus/virginiana.htm)	Figure 11.21	Figure 11.22

Quercus bicolor

Back



Figure 11.6. *Quercus bicolor* leaf shape. Source: W.D. Brush, USDA Forest Service. Provided By National Agricultural Library, USDA-NRCS PLANTS Database.



(<https://pressbooks.bccampus.ca/geoglabmanualv2/wp-content/uploads/sites/1340/2021/03/Quercus-bicolor.png>)

Figure 11.7. *Quercus bicolor* distribution map. Source: U.S. Department of Agriculture (https://www.srs.fs.usda.gov/pubs/misc/ag_654/volume_2/quercus/bicolor.htm). Public Domain. [Click to view image full size]

Quercus chrysolepis

Back

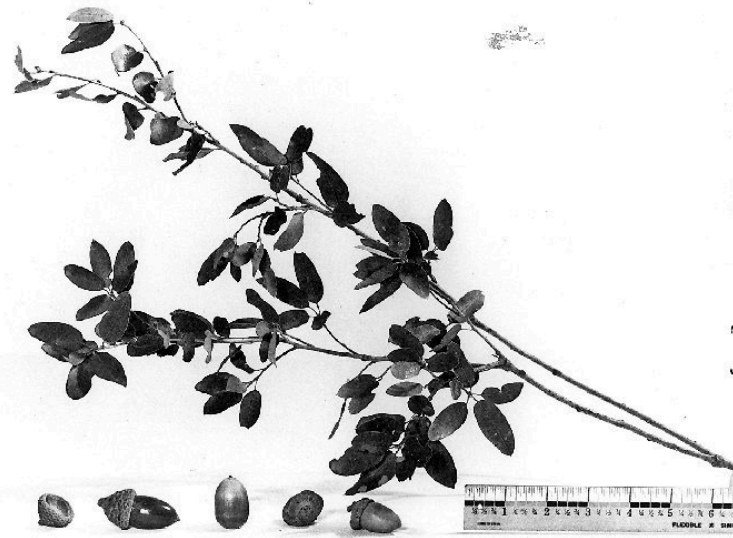


Figure 11.8. *Quercus chrysolepis* leaf shape. Source: Fred E. Dunham, USDA Forest Service, 1938. Provided By National Agricultural Library, USDA-NRCS PLANTS Database.



(<https://pressbooks.bccampus.ca/geoglabmanualv2/wp-content/uploads/sites/1340/2021/03/Quercus-chrysolepis.png>)

Figure 11.9. *Quercus chrysolepis* distribution map. Source: U.S. Department of Agriculture (https://www.srs.fs.usda.gov/pubs/misc/ag_654/volume_2/quercus/chrysolepis.htm). Public Domain. [Click to view image full size]

162 Gillian Krezoski

Quercus douglasii

Back

Q douglasii (http://www.efloras.org/florataxon.aspx?flora_id=1&taxon_id=233501022) [illustration]



(<https://pressbooks.bccampus.ca/geoglabmanualv2/wp-content/uploads/sites/1340/2021/03/Quercus-douglasii.png>)

Figure 11.10. *Quercus douglasii* distribution map.

Source: U.S. Department of Agriculture

(https://www.srs.fs.usda.gov/pubs/misc/ag_654/)

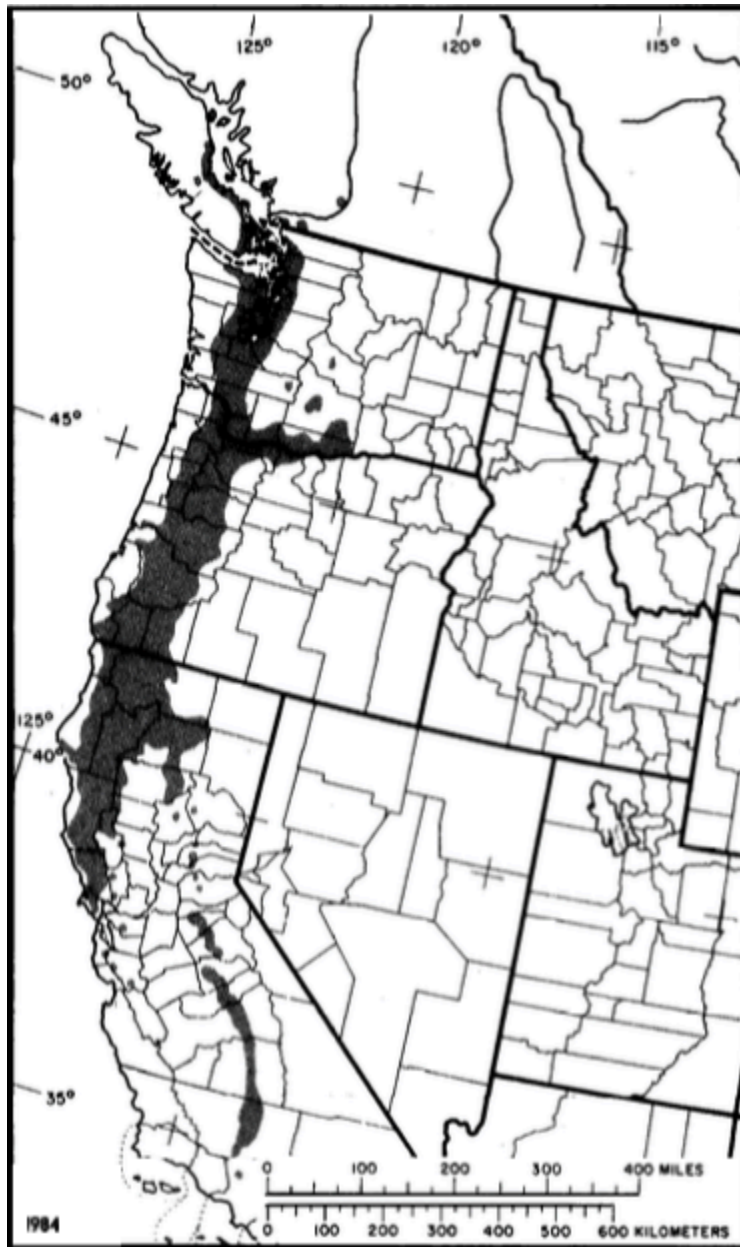
[volume_2/quercus/douglasii.htm](#)). Public Domain.
[Click to view image full size]

Quercus garryana

Back



Figure 11.11. *Quercus garryana* leaf shape. Source: G. Krezoski (2021).



(<https://pressbooks.bccampus.ca/geoglabmanualv2/wp-content/uploads/sites/1340/2021/03/Quercus-garryana.png>)

Figure 11.12. *Quercus garryana* distribution map. Figure courtesy of the U.S. Department of Agriculture (https://www.srs.fs.usda.gov/pubs/misc/ag_654/volume_2/quercus/garryana.htm). Public Domain. [Click to view image full size]

Quercus laurifolia

Back

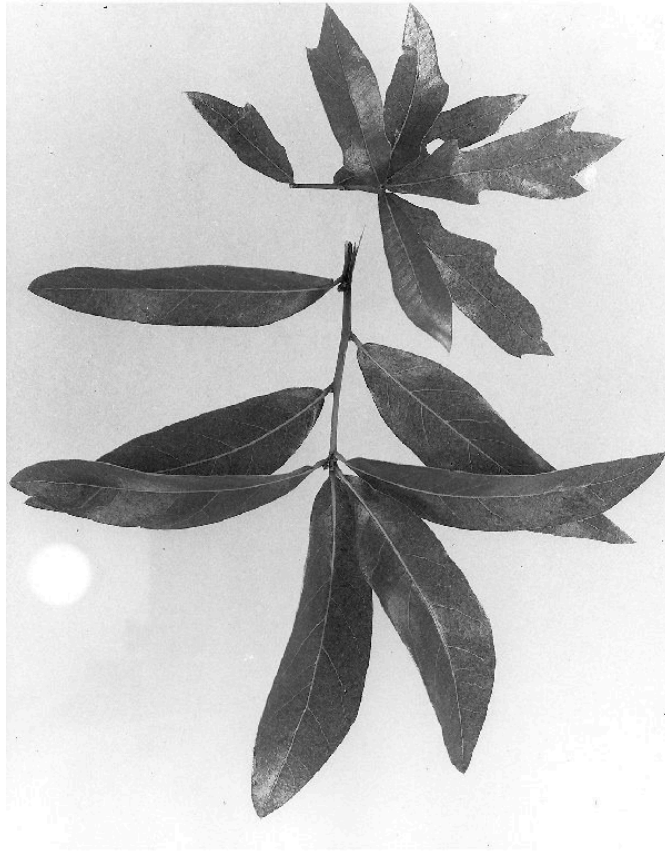
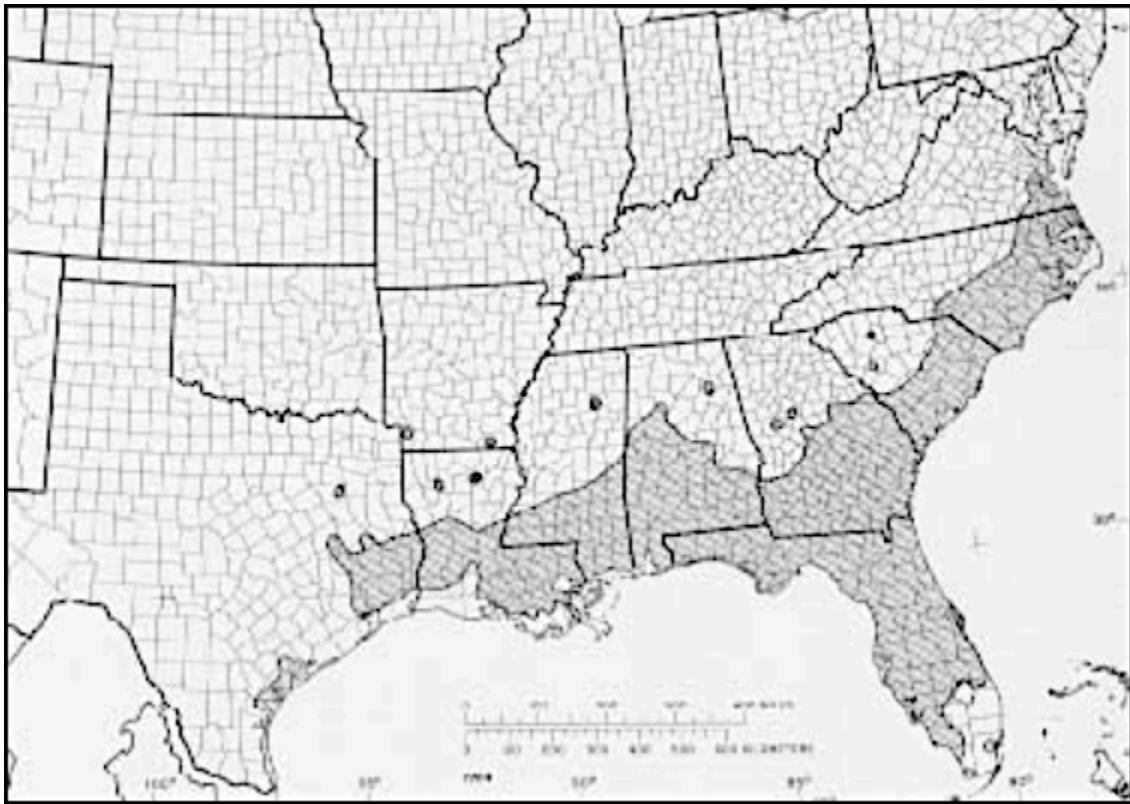


Figure 11.13. *Quercus laurifolia* leaf shape. Source: W.D. Brush, USDA Forest Service. Provided By National Agricultural Library, USDA-NRCS PLANTS Database.



(<https://pressbooks.bccampus.ca/geoglabmanualv2/wp-content/uploads/sites/1340/2020/07/Figure-11.12-Quercus-laurifolia-distribution-map.png>)

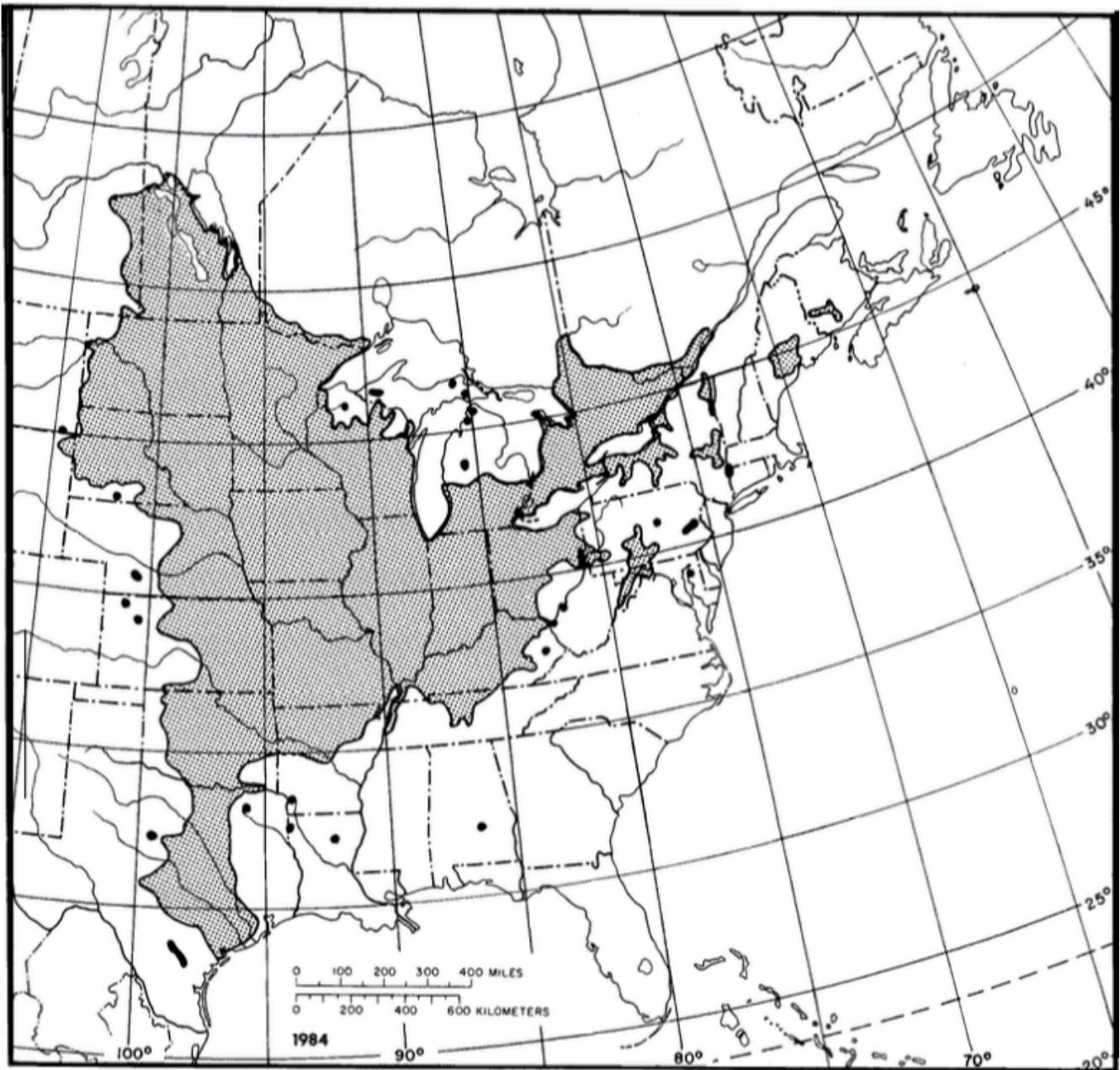
Figure 11.14. *Quercus laurifolia* distribution map. Figure courtesy of the U.S. Department of Agriculture (https://www.srs.fs.usda.gov/pubs/misc/ag_654/volume_2/quercus/laurifolia.htm). Public Domain. [Click to view image full size]

Quercus macrocarpa

Back



Figure 11.15. *Quercus macrocarpa* leaf shape. Source: W.D. Brush, USDA Forest Service. Provided By National Agricultural Library, USDA-NRCS PLANTS Database.



(<https://pressbooks.bccampus.ca/geoglabmanualv2/wp-content/uploads/sites/1340/2021/03/Quercus-macrocarpa.png>)

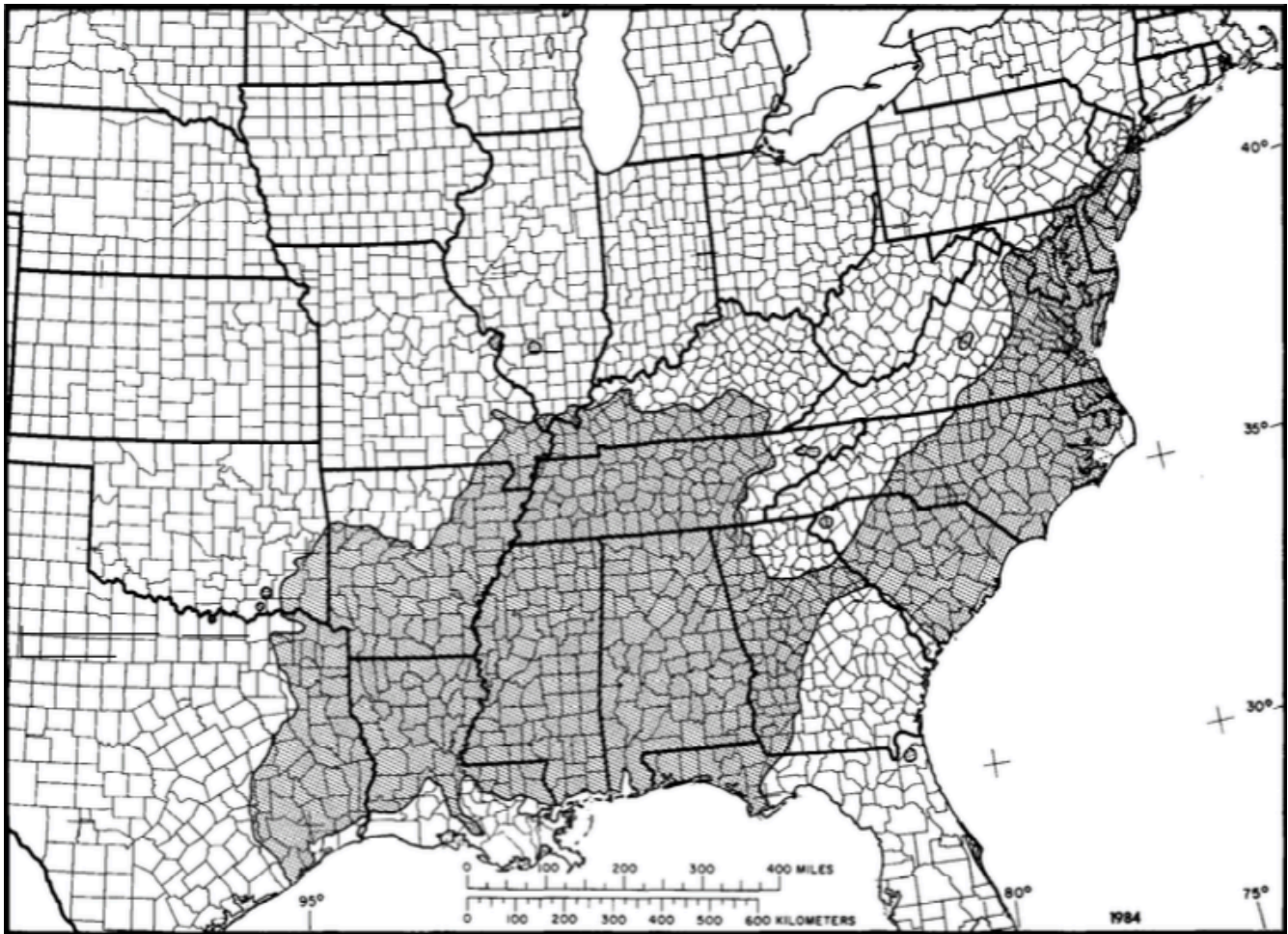
Figure 11.16. *Quercus macrocarpa* distribution map. Source: U.S. Department of Agriculture (https://www.srs.fs.usda.gov/pubs/misc/ag_654/volume_2/quercus/macrocarpa.htm). Public Domain. [Click to view image full size]

Quercus phellos

Back



Figure 11.17. *Quercus phellos* leaf shape. Source: W.D. Brush, USDA Forest Service. Provided By National Agricultural Library, USDA-NRCS PLANTS Database.



(<https://pressbooks.bccampus.ca/geoglabmanualv2/wp-content/uploads/sites/1340/2021/03/Quercus-phellos.png>)

Figure 11.18. *Quercus phellos* distribution map. Source: U.S. Department of Agriculture (https://www.srs.fs.usda.gov/pubs/misc/ag_654/volume_2/quercus/phellos.htm). Public Domain. [Click to view image full size]

Quercus rubra

Back

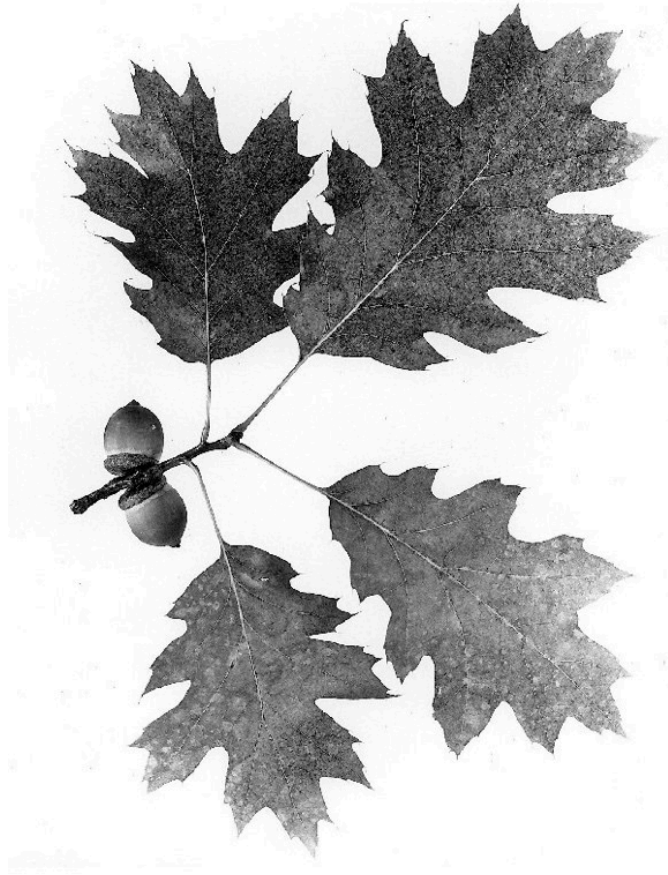
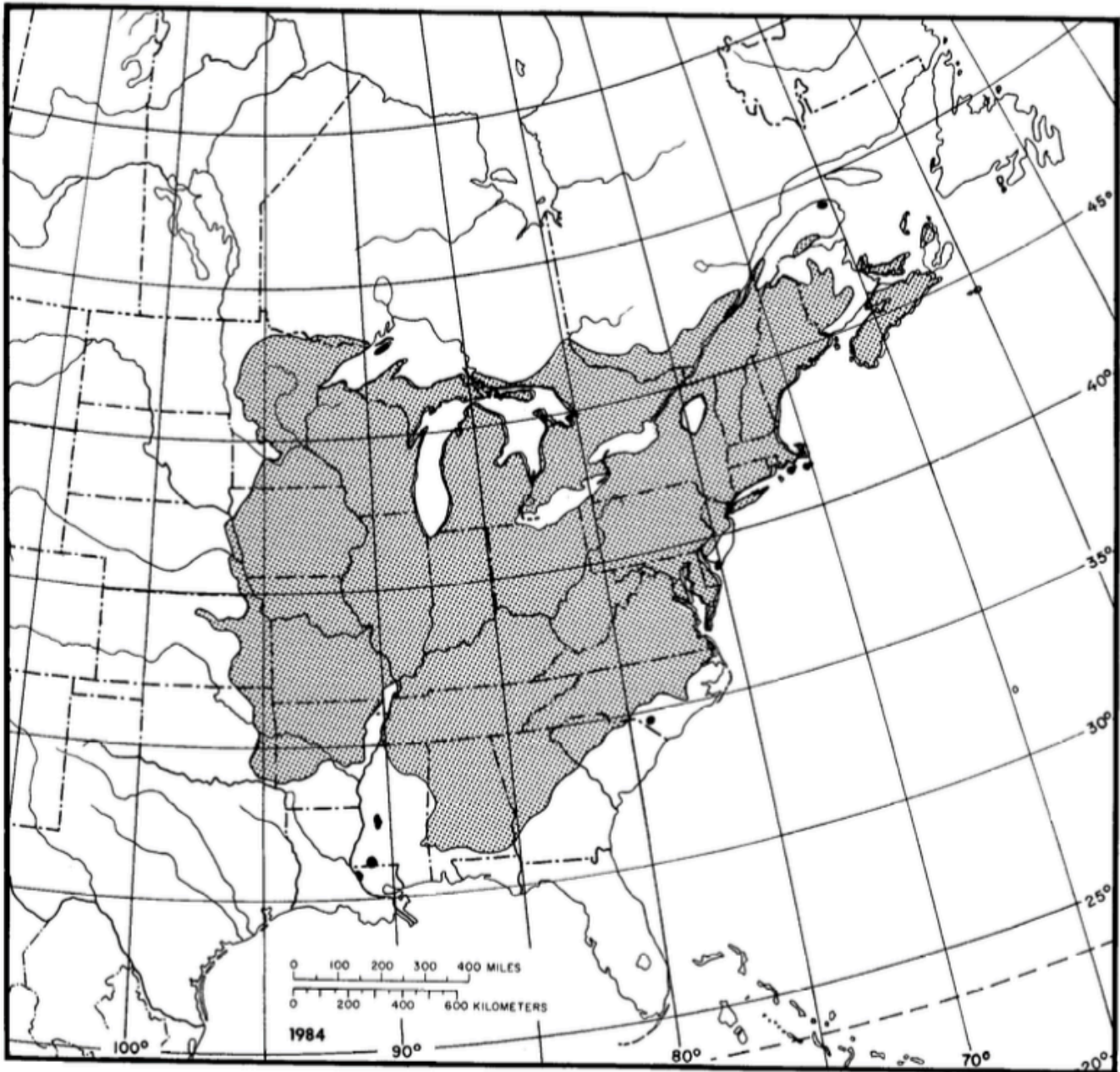


Figure 11.19. *Quercus rubra* leaf shape. Source: W.D. Brush, USDA Forest Service. Provided By National Agricultural Library, USDA-NRCS PLANTS Database.



(<https://pressbooks.bccampus.ca/geoglabmanualv2/wp-content/uploads/sites/1032/2020/07/Quercus-rubra.png>)

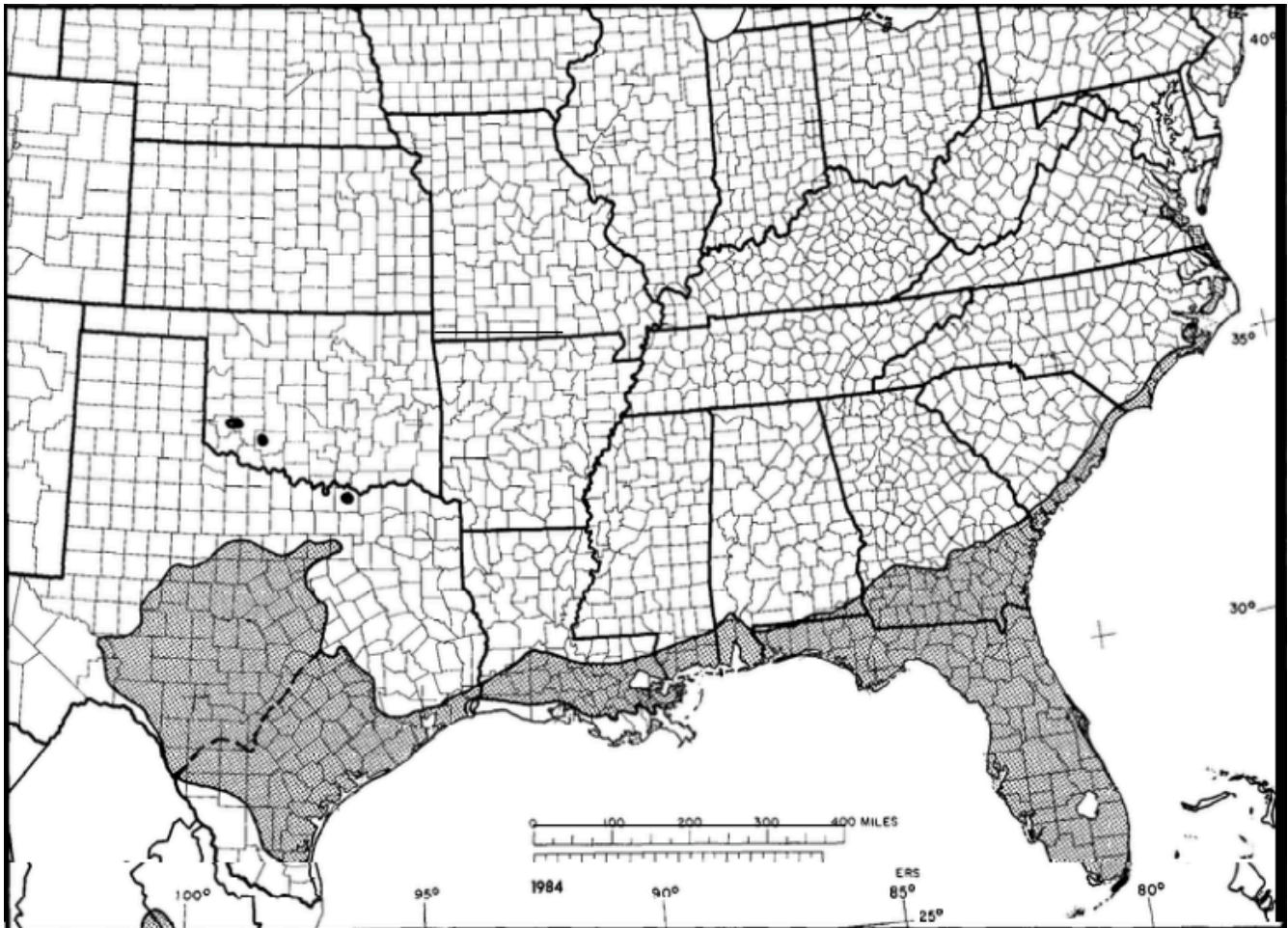
Figure 11.20. *Quercus rubra* distribution map. Source: U.S. Department of Agriculture (https://www.srs.fs.usda.gov/pubs/misc/ag_654/volume_2/quercus/rubra.htm). Public Domain. [Click to view image full size]

Quercus virginiana

Back



Figure 11.21. *Quercus virginiana* leaf shape. Source: W.D. Brush, USDA Forest Service. Provided By National Agricultural Library, USDA-NRCS PLANTS Database.



(<https://pressbooks.bccampus.ca/geoglabmanualv2/wp-content/uploads/sites/1340/2021/03/Quercus-virginiana.png>)

Figure 11.22. *Quercus virginiana* distribution map. Source: U.S. Department of Agriculture (https://www.srs.fs.usda.gov/pubs/misc/ag_654/volume_2/quercus/virginiana.htm). Public Domain. [Click to view image full size]

References

- Christopherson, R.W. et al., (2019). *Geosystems: An introduction to physical geography* (4th ed). Pearson Canada Inc.
- National Geographic Resource Library. (2020). *Koppen climate classification system*. National Geographic. <https://www.nationalgeographic.org/encyclopedia/koppen-climate-classification-system/>
- Pellatt, M.G., Gedalof, Z. (2014). Environmental change in Garry oak (*Quercus garryana*) ecosystems: the evolution of an eco-cultural landscape. *Biodiversity and Conservation*, 23, 2053–2067. <https://doi.org/10.1007/s10531-014-0703-9>
- UC Museum of Paleontology (2019) *The world's biomes*. <https://ucmp.berkeley.edu/exhibits/biomes/index.php>

United States Department of Agriculture: Natural Resources Conservation Service, (n.d.). *PLANTS database*. <https://plants.usda.gov/home>

United States Department of Agriculture. (1990) Volume 2: Hardwoods. *Silvics of North America*. pp. 605-753. https://www.srs.fs.usda.gov/pubs/misc/ag_654/volume_2/vol2_table_of_contents.htm

Image Descriptions

Figure 11.1 Biomes of the world.

A world map showing the different types of biomes:

- Tundra
- Taiga
- Montane grasslands and shrublands
- Temperate coniferous forest
- Temperate broadleaf and mixed forests
- Temperate grasslands, savannas, and shrublands
- Tropical and subtropical moist broadleaf forests
- Tropical and subtropical dry broadleaf forests
- Tropical and subtropical grasslands, savannas, and shrublands
- Mediterranean forests, woodlands, and scrub
- Deserts and xeric shrublands
- Flooded grasslands and savannas
- Mangroves

[Return to Figure 11.1]

Lab 12: Coastal Forest Virtual Field Trip

Nina Hewitt

British Columbia's coastal forests are some of the most productive in the world. In particular, the mild rainy winters sustain the regional evergreen needleleaf (conifer) species that occur, and that attain truly goliath proportions over their long lifespans. Coastal forests sustain a species-rich biota ranging from tiny edaphic (soil) organisms, to mammals, birds, and understory plants. Several nations of Coast Salish peoples (including the Musqueam, Squamish, Tsleil-Waututh Nations) have lived sustainably in the region for millennia. Since European settlement, many coastal forests in the lower mainland region have been extensively logged and some converted completely to other human land uses.

This lab explores a large remnant of Coastal forest in Pacific Spirit Park [VIDEO] (https://youtu.be/tMUjIz_2zjs), Point Grey, Vancouver, to examine its species composition, structure, and dynamics, particularly in relation to human and natural disturbance processes. A set of 360° photos and videos (one in 360°) will be used to demonstrate the local species and landscapes. At the end of the lab, you will have an appreciation for the main species present and the sorts of processes that affect coastal forest dynamics, both natural and human-caused.

Learning Objectives

After completion of this lab, you will be able to

- Become familiar with the species composition, structure and disturbance ecology of BC's coastal forest ecosystems via an immersive digital experience.
- Use a dichotomous key to name and identify tree and shrub species present in coastal forests.
- Make field observations of forest stand structure and species composition and apply these to infer disturbance histories and predict future changes.
- Summarize some techniques for studying forests, including tree-ring dating (dendrochronology).
- Learn about and identify some of the woody invasive species that have been introduced into Vancouver's Pacific Spirit Forest and other local ecosystems.
- Consider some of the forest management practices of Indigenous peoples in the region and how these practices contrast with those of modern settlers.

Pre-Readings

Forest Ecosystems, Ecological Disturbance, and Plant Succession

In order to complete this lab, some background information in forest ecosystems, plant succession, and disturbance processes is required. Consult your text and lecture materials to review background concepts of forest structure and dynamics, and concepts of ecological disturbance and succession. An overview is provided here.

Disturbance

Disturbance is a pervasive process in ecosystems. In the context of vegetation dynamics, it may be defined as any event that destroys part or all of the above-ground vegetation in an ecosystem. Disturbance includes wildfire, flooding, large-scale disease outbreaks, and major windstorms. Once viewed as a negative force acting on ecosystems, disturbance is now recognized as integral and essential to the function of many ecosystems. In forest ecosystems **fire** is often a critical disturbance. It has been a regular feature of BC's dry interior ecosystems and even to some degree in the wetter coastal regions of this field trip. Fire-adapted species require regular, frequent fires to remove competition, prepare the soil for their seeds by removing litter and, for some conifers, provide the intense heat needed to open cones and release seeds. Without periodic fires, species in fire-prone ecosystems would gradually be replaced with less fire-adapted species.

For millennia in North America, wildfires were ignited by lightning or Indigenous peoples. However, European settlers engaged in fire suppression in many ecosystems for decades. Thanks to growing scientific evidence, land managers now recognize fire's role and, over the last several decades, have begun to implement **controlled** or **prescribed** burns to restore this critical ecosystem process. Nevertheless, catastrophic fires have become increasingly frequent and intense in recent years due to a combination of factors, including previous fire suppression and buildup of dead wood that increases fuel loads, as well as hotter, drier conditions, and insect outbreaks associated with climate change. Although these newsworthy catastrophic fires have had tragic consequences for human populations, fire must be recognized as a critical ecosystem process in many systems, and considered in conservation and management agendas (Hewitt in Arbogast et al., 2018).

Plant Succession

Plant succession refers to gradual changes in plant community composition and structure that occur following large-scale disturbance (e.g., fire, logging, or cultivation) or on areas of new terrain (e.g., recently exposed glacial till, lava flows). Initial colonizing plant species are referred to as **pioneer** species. These are plants that arrive quickly via effective seed dispersal, or that are adapted to grow rapidly in the open, well-lit conditions of early succession. Other names for pioneer species include **r-selected species** or **r-strategists**, and **early-successional species**. They may contribute to the establishment of additional species via root penetration and the cycling of organic material and minerals in the soil, though their role may be less pivotal in facilitating subsequent plant populations than once assumed. Later in succession, additional plant species establish populations as their seeds arrive from neighbouring sites, or, if the substrate is intact (e.g., following fire), as they emerge from buried seed and vegetative plant parts in the soil. In time, trees and shrubs mature, casting shade and

altering the microclimate at ground level. The changes in humidity and soil temperature create conditions for shade-adapted understory plant species to establish. If a major disturbance such as fire or human activity does not occur, an increasingly complex community structure may develop, and species more adapted to shady understory conditions may dominate. These mid-to-late successional species are sometimes categorized as **k-strategists** (or climax species, particularly in older literature).

Succession was previously considered a relatively predictable process in which a sequence of plant communities replaced one another in a unidirectional fashion, with a stable endpoint called a climax community. Today, it is recognized to be a much less orderly process and that the climax concept is misleading. The particular sequence of changes may be random as a result of stochastic processes (involving an element of randomness), such as dispersal, that affect which species will establish. Patterns of succession may vary even across similar sites within one ecological region. Further, given the prevalence of disturbance, succession may be interrupted and reset frequently, for example, in fire-prone ecosystems, so there is no guarantee that the elusive climax community will take hold. Thus, while this idea of a uniform, highly predictable successional process continues to be articulated in many university textbooks (Johnson and Miyanishi, 2008), the evidence exists for a more stochastic, less predictable trajectory of change.

Forest Structure

Forests are complex associations of tall, woody vegetation (trees, both alive, and as standing dead wood) and smaller stature species of woody shrubs, herbs (e.g., ferns and ephemeral flowering plants like lilies), as well as a ground layer that includes living plants (eg, mosses, lichen), and dead, decaying litter on the forest floor. The vertical and horizontal distribution of these different subsets is the forest structure (Figure 12.1).

Structure encompasses a variety of properties related to these different structural layers that influence ecosystem function. For example the depth and extent of the forest canopy that intercepts solar radiation influences the micro-climate (temperature, shadiness) of the forest understory. The number and position of nesting cavities in tree trunks influences wildlife habitat and the trophic functioning of the ecosystem. The number of tip-up mounds produced by fallen trees affects conditions for plant establishment...

Forest ecologists are often interested in how species in the tree layer are distributed into different size classes (small, medium, large), as measured by tree height and diameter. Tree diameter, the distance through the centre of the trunk, is generally measured at chest height. This information can hint at when the trees established, which species are dominant, especially in the canopy (in terms of size and abundance), which species are likely to replace the canopy species (the species of smaller stemmed individuals) and more. Therefore, the present structure provides clues about forest history and its future development.

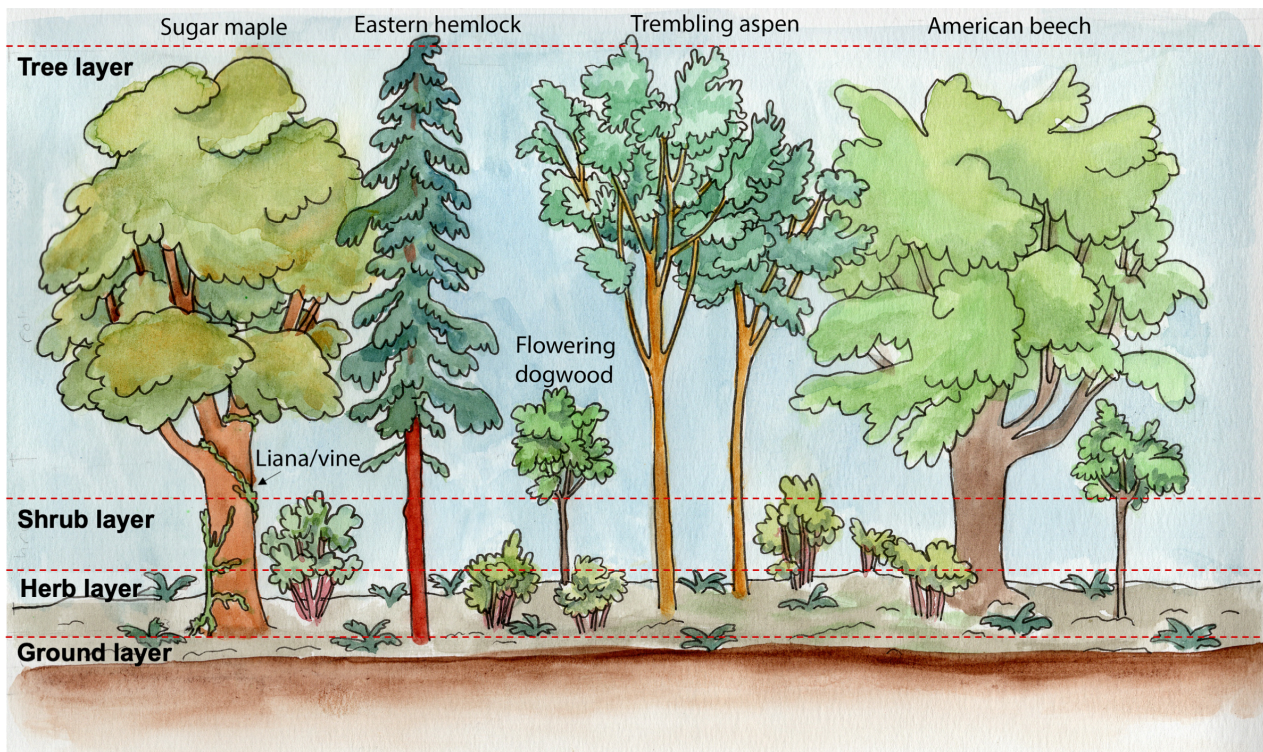


Figure 12.1. Diagram of the structure of a forest and its layers. Tree, shrub, herb, and ground layers, for an eastern deciduous forest are shown. The species' identities will vary depending upon the ecosystem. In BC's coast region, within later-successional stands, the rainy west coast marine climate favours long-lived evergreen conifers over deciduous broadleaf species. Source: S. Hewitt-Wood, CC BY-NC-SA 4.0. [Image description]

Background Information About the Tour Location

Park History

The Park was initially a part of the UBC Endowment Lands which were set aside in 1923 by the BC government to be used as a source of revenue for the fledgling University of British Columbia. Logging for export to European markets was the main revenue generator. Eventually, all but a narrow band of forest along the western tip of Point Grey was harvested. Today the forest is mostly second growth that established after logging or more recent disturbances. In 1975, the provincial government designated part of the UBC Endowment Lands as an ecological reserve and Pacific Spirit Park was established in 1989 (UBC Geography, 2019).

Vegetation and Soils

Both human activity and soils influence the tree and understory plant species across the park. Differences in the kind of past disturbance as well as the severity and timing, have contributed to the patchwork of varied plant associations throughout the park. The soils vary considerably among locations, although they are influenced by the same general climate and have common parent materials. Podzols underlie much of the park and are characterized by a leached layer where minerals and decayed organic matter have been removed by rain seeping through the soil. Differences in soils between sites can be attributed to the growth and decay of organic material, which itself varies between sites based on local topography, the distribution of water and drainage of rainfall, and vegetation cover

(UBC Geography, 2019). A video interpreting the soils in the Park in the second growth needleleaf forest is available at Second Growth Forest – Soil Description (<https://youtu.be/cQ1JahJ7LFI>).

Dichotomous Key to Common Trees in Pacific Spirit Park

A **key** is a tool for identifying plants. Download and view the **Key to Common Trees in Pacific Spirit Park** from the Supporting Material. A simplified **Pictorial Key to Common Trees in Pacific Spirit Park** is also available for you in the Supporting Material, but you should be able to work with the language in the text-based key. This is called a **dichotomous key** because characteristics of the plant are described in couplets (e.g., 1a and 1b). For each species, only one of the two statements is accurate. For each accurate description, follow the instructions indicated in the right column; continue to the next pair of couplets or note the identification of the plant. Ultimately you will determine the genus and species of each plant using this key or by referring to other field guides. Remember to follow protocol when using scientific names of plants. An asterisk (*) next to a species name in the key indicates non-native species.

It is important to learn how to use a plant key and to become familiar with the vocabulary used to describe plants. The vocabulary is very specific to plant taxonomy and requires some attention. In particular, the following terms will be useful when using the key:

- **Simple:** a broadleaf, with only a single blade and is joined by its stalk to a twig or branchlet that is woody.
- **Compound:** a broadleaf, with several distinct leaflets attached to a midrib that is not woody. It is the stalk of the midrib that is attached to the woody twig.
- **Leaflet:** leaf-like subdivision of compound leaves, species usually have a characteristic number of leaflets per leaf.
- **Alternate:** leaves (simple or compound) are arranged singly at intervals along the twig.
- **Opposite:** leaves (simple or compound) that occur in opposing pairs along the twig.
- **Lobed:** a leaf with incompletely separated, rounded or bristle-tipped sections.
- **Toothed:** a leaf having large, dentate or serrate teeth at its edges.
- **Palmate** – leaf structures (e.g., veins or leaflets of compound leaves) radiating out from a common point
- **Pinnate** – leaf structures (e.g., veins or leaflets of compound leaves) distributed along a central line
- **Branchlet:** the end portion of a branch containing the previous year's growth

Illustrations of a number of these features are provided on Figure 12.2.

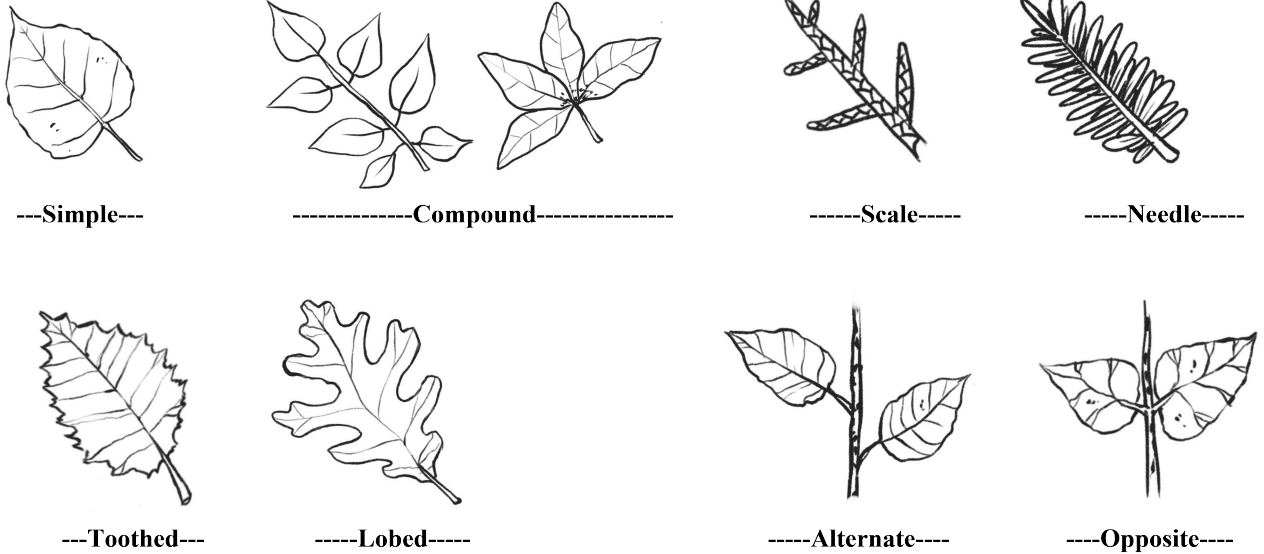


Figure 12.2. Illustration of key terms used to identify plants. Source: S. Hewitt-Wood, CC BY-NC-SA 4.0.

Lab Exercises

In this lab, you will

- Identify BEC zones and related climate information.
- Examine the forest stand structure and species composition of Pacific Spirit Forest along the Spanish Trail through an immersive virtual tour.
- Complete a self-guided tour on which you will identify plants growing in your local neighbourhood.

This lab consists of 4 exercises. Exercises 1-3 are completed online and should take about 2-3 hours to complete. Exercise 4 includes outdoor data collection and should take an hour or so.

EX1: Identify the BEC Zone for the Forest Tour

BC's original coastal forest ecosystems have been classified using the Biogeoclimatic Ecosystem Classification System (<https://www.for.gov.bc.ca/hfd/library/documents/treebook/biogeno/biogeno.htm>) (BEC zone). In this exercise you will identify the two main types of coastal forests in BC, including the one where this tour is situated. This exercise should take 10-15 minutes to complete.

Step 1: Open Google Maps (<https://www.google.ca/maps>) and enter these coordinates to locate the tour: 49°16'07.9"N, 123°14'09.5"W (49.268851, -123.235963).

Step 2: Go to the BC Climate Explorer (<http://www.bc-climate-explorer.org/>). Note: If the window remains blank, set your internet browser for this site to **trusted**. Locate the tour area by zooming into the map near

known features (e.g., coastlines, rivers) based on the location you have identified in Google Maps. To zoom in on this website, you may need to double click on the map; to zoom out, you may need to use the command **-**.

Step 3: In Climate Explorer, click **BEC UNIT** at the top under **Map By**. The BEC zone and subzone abbreviations will appear when you hover the cursor over the site location. For example, you may see **PPxh1**, which is an abbreviation for **Ponderosa Pine Okanagan very dry hot**. Find full zone names at BEC Zone and Subzone Descriptions (<https://www.for.gov.bc.ca/HRE/becweb/resources/classificationreports/subzones/index.html>). Navigate to the area of Pacific Spirit Park, using the landmarks on Google Maps.

Step 4: Go to Biogeoclimatic Ecosystem Classification System in British Columbia (<https://selkirk.ca/discover/bec/zones/zones.html>). Hover over the zone name to view the map. Click on the zone name to see its description. The Introduction page for each zone includes a description of its climate conditions.

1. Record the abbreviation and full zone and subzone names for the following:
 - a. Pacific Spirit Park tour site.
 - b. Another adjacent/nearby coastal forest type common in the region.

Using websites in Step 3 and Step 4 of this exercise, briefly describe the following:

- a. The climate conditions, including temperature and rain/snowfall conditions of Pacific Spirit Park's BEC zone. A climograph of the region is available for your perusal at Climate Vancouver (Canada) (<https://en.climate-data.org/north-america/canada/british-columbia/vancouver-963/>).
- b. The main ecosystem characteristics, and 3-4 of the major tree species found in this zone (2-3 sentences). Note that this zone is variable within, and you may not see all of these species along the tour.

EX2: Take the Tour!

Now that you are aware of the regional context, you are ready to begin the tour. It starts at the head of the Spanish Trail where College Highroad meets Pacific Spirit Park as shown on the Pacific Spirit Forest Tour in Map 12.1 below. To zoom into the map, use the **+** icon. You may click the blue markers and a sidebar will appear with a brief overview of three major locations we will visit on the tour.

Map 12.1. Pacific Spirit Forest Tour Map.



An interactive H5P element has been excluded from this version of the text. You can view it online here: <https://pressbooks.bccampus.ca/geoglabmanualv2/?p=193#h5p-3> (<https://pressbooks.bccampus.ca/geoglabmanualv2/?p=193#h5p-3>)

Note: For a more immersive experience, at anytime you may try this Interactive 360 H5P version of the Pacific Spirit Forest Tour (<http://blogs.ubc.ca/alpineplants/interactive-360-pacific-spirit-tour/>). Only the 360

photos and videos are embedded, however, so you will need to view the other learning materials (photos, text, linked resources) in the body of this lab.

We respectfully acknowledge that this tour takes place on the traditional, ancestral and unceded territory of the x^wməθk^wəyəm (Musqueam) People. We are grateful for the chance to study and enjoy this ecosystem, which they have sustained for millennia, and continue to do so.

Introduction

Step 1: Watch the tour introduction in Video 12.1. This is a 360 video, so you may click and drag within the video to explore the .

Video 12.1. Introduction to Pacific Spirit Park Tour (<https://www.youtube.com/watch?v=3Q9PaUpntSQ>). Transcript available: [Word] (<https://pressbooks.bccampus.ca/geoglabmanualv2/wp-content/uploads/sites/1340/2021/08/Video-12.1-Transcript-Introduction.docx>) [ODT] (<https://pressbooks.bccampus.ca/geoglabmanualv2/wp-content/uploads/sites/1340/2021/08/Video-12.1-Transcript-Introduction.odt>) [PDF] (<https://pressbooks.bccampus.ca/geoglabmanualv2/wp-content/uploads/sites/1340/2021/08/Video-12.1-Transcript-Introduction.pdf>)



One or more interactive elements has been excluded from this version of the text. You can view them online here: <https://pressbooks.bccampus.ca/geoglabmanualv2/?p=193#oembed-1> (#oembed-1)

As you learned in Video 12.1, the disturbance event that led to stand initiation here was a human-caused one. In 1952 the site was cleared of trees, stumps, and even topsoil to make way for a residential development. Clearly, the development plan did not go through, explaining why you see second-growth forest here, rather than apartments! Broadleaf, deciduous tree species regenerated spontaneously following the disturbance.

Step 2: Click and drag within 360 Photo 12.1 to explore the head (start) of the Spanish Trail in 360°.

360 Photo 12.1. The Spanish Trailhead.



An interactive H5P element has been excluded from this version of the text. You can view it online here: <https://pressbooks.bccampus.ca/geoglabmanualv2/?p=193#h5p-45> (<https://pressbooks.bccampus.ca/geoglabmanualv2/?p=193#h5p-45>)

Step 3: Using Video 12.1 and 360 Photo 12.1, be a **field ecologist** and apply your observational skills, paying particular attention to visible evidence of:

- Species composition: inferred from, e.g., bark characteristics (color, texture/pattern); plant type, based on life-form by forest layer (shrub vs. tree; see Figure 12.1), stem morphology and branch pattern, etc.
- Age structure: inferred from the range of stem sizes visible. Is this a stand with even-aged stems or one with stems in lots of different size/age categories? Note your responses.

Stop #1: Broadleaf Forest

Before we move into this first stop, a word of clarification about the terms broadleaf and hardwood. Broadleaf and hardwood are terms related to morphology and forestry. They both refer to woody, angiosperm (flowering plant (https://en.wikipedia.org/wiki/Flowering_plant)), taxa. Broadleaf refers to the leaf shapes typical among woody angiosperms (as opposed to needleleaf, which you will meet at Stop #2). Hardwood refers to the harder (more dense) wood typical of these species.

Step 4: Watch Video 12.2 Broadleaf (Hardwood) Forest.

Video 12.2. Broadleaf (hardwood) forest (<https://www.youtube.com/watch?v=Stsszgnet-U>). Transcript available: [Word] (<https://pressbooks.bccampus.ca/geoglabmanualv2/wp-content/uploads/sites/1340/2021/08/Video-12.2-Transcript-Broadleaf.docx>) [ODT] (<https://pressbooks.bccampus.ca/geoglabmanualv2/wp-content/uploads/sites/1340/2021/08/Video-12.2-Transcript-Broadleaf.odt>) [PDF] (<https://pressbooks.bccampus.ca/geoglabmanualv2/wp-content/uploads/sites/1340/2021/08/Video-12.2-Transcript-Broadleaf.pdf>)



One or more interactive elements has been excluded from this version of the text. You can view them online here: <https://pressbooks.bccampus.ca/geoglabmanualv2/?p=193#oembed-2> (#oembed-2)

Step 5: Click and drag within 360 Photo 12.2 to explore Stop 1 in 360°.**360 Photo 12.2. Stop 1: Broadleaf forest.**

An interactive H5P element has been excluded from this version of the text. You can view it online here: <https://pressbooks.bccampus.ca/geoglabmanualv2/?p=193#h5p-7> (<https://pressbooks.bccampus.ca/geoglabmanualv2/?p=193#h5p-7>)

360 Photo 12.3 is the same scene in midsummer, June 17 2020, when deciduous trees had leafed out.

360 Photo 12.3. Stop 1: Broadleaf forest. June 2020.

An interactive H5P element has been excluded from this version of the text. You can view it online here: <https://pressbooks.bccampus.ca/geoglabmanualv2/?p=193#h5p-8> (<https://pressbooks.bccampus.ca/geoglabmanualv2/?p=193#h5p-8>)

Ideas to consider before proceeding to the next step: Can you identify the two main species discussed in the video and shown in Figure 12.3? Use your **Key to Common Trees in Pacific Spirit Park** to find their Latin binomials and common names. Both species are early successional, and these individuals recruited shortly after the site had been disturbed when there was no tree canopy, little competition, and ample light. One of these species is more abundant (common) than the other in this forest. You should be able to determine which

by looking around the photosphere once you can identify each from its bark (see Video 12.2 for clues) and other features, even without leaves on the trees!

a. Mystery hardwood species #1



b. Mystery hardwood species #2



Figure 12.3. a. (including inset) Tree species at Stop 1. Leaves and catkins of the first tree species examined, the **dominant** tree in this forest. Catkins are male reproductive parts containing pollen. Female flowers for this species develop into woody brown cones. You will see its bark in Video 12.2, 360 Photo 12.2 and 360 Photo 12.3. b. Leaves of the 2nd tree species examined in the video. Sources: Left: US Bureau of Land Management [JPG], (https://commons.wikimedia.org/wiki/File:Red_alder_leaves.jpg) Public Domain. Inset: W. Siegmund (2006) [JPG] (https://commons.wikimedia.org/wiki/File:Alnus_rubra_9819.JPG), CC BY-SA. Right: Photo courtesy of Amiyashrivatstava (2012) [JPG] (https://commons.wikimedia.org/wiki/File:Seeds_and_Fluff_of_Cottonwood.jpg), CC BY-SA.

Have a think about the sorts of characteristics these species have that allow them to arrive and thrive in recently disturbed sites. You may wish to refer to your text or lecture materials. These characteristics are **adaptations**, traits that evolved over time that help to match the species with the type of environment for which it is specialized. In this context, examples of the type of environment include open, recently disturbed sites and shady, undisturbed sites). A few considerations:

- Seed size vs. seed numbers: There is often a trade-off between the size of a species's seeds and the number it can produce with limited resources – species tend to fall into categories, either producing many small seeds (**many-small**), or else few large seeds (**few-large**) (Leishman, 2001).
- Seed dispersal characteristics: Do the seeds have appendages such as plumes or wings to be scattered broadly by wind, or do they have tasty coverings to attract animal dispersers and be placed in specific locations? For further details, read Seed Dispersal – How Plants Spread (<http://theseedsite.co.uk/dispersal.html>). More importantly, how do these dispersal syndromes affect the chances of arriving and surviving in particular sites? Hint: Species in the many-small seed category have a decent chance of at least some arriving in recent openings. Species that produce a few large seeds have larger seed nutrient reserves to enable establishment in closed, shady sites where sunlight at the ground may be limited. At the same time, in these coastal forests, most tree species fall into the many-small seeds grouping. Nature often defies our simple

attempts at categorization!

Are there other sorts of disturbances that might affect the forest? You might see some clues of more small-scale disturbance in 360 Photo 12.2 and 360 Photo 12.3. Clues include broken branches and signs of disease. Refer to your text or lecture materials for a discussion of disturbances, small and large-scale.

Have a think about how this site will change in future. The answer will be relevant in EX3. Go to the next step for more clues.

Step 6: View Video 12.3 in which Kevin Pierce chats about clues that indicate how this early successional broadleaf stand may change. Kevin is a UBC Geography PhD candidate and Teaching Assistant (2017-18) who led students on in-person field trips to this forest (shared with permission from KP; videographer, K Hurley, Mar 2019).

Video 12.3. Interpreting the Forest Structure and Signs of Change (https://www.youtube.com/watch?v=7hs_yfNmns). Transcript available: [Word] (<https://pressbooks.bccampus.ca/geoglabmanualv2/wp-content/uploads/sites/1340/2021/08/Video-12.3-Transcript-Interpreting.docx>) [ODT] (<https://pressbooks.bccampus.ca/geoglabmanualv2/wp-content/uploads/sites/1340/2021/08/Video-12.3-Transcript-Interpreting.odt>) [PDF] (<https://pressbooks.bccampus.ca/geoglabmanualv2/wp-content/uploads/sites/1340/2021/08/Video-12.3-Transcript-Interpreting.pdf>)



One or more interactive elements has been excluded from this version of the text. You can view them online here: <https://pressbooks.bccampus.ca/geoglabmanualv2/?p=193#oembed-3> (#oembed-3)

Step 7: Now watch Video 12.4 in which biogeographer Nina Hewitt demonstrates how to date disturbance. In the video, a ring series known as a **tree-ring core** is extracted from one of the largest, and oldest, stems at Stop 1. The ring counts and age of this tree tell how long ago it established, indicating the approximate timing of the disturbance event that led to stand initiation at the site. This is species x – the one you were asked to identify first.

Video 12.4. How to Date Disturbance (<https://www.youtube.com/watch?v=OQQaeZ05u7c>). Transcript available: [Word] (<https://pressbooks.bccampus.ca/geoglabmanualv2/wp-content/uploads/sites/1340/2021/08/Video-12.4-Transcript-Dendrochronology.docx>) [ODT] (<https://pressbooks.bccampus.ca/geoglabmanualv2/wp-content/uploads/sites/1340/2021/08/Video-12.4-Transcript-Dendrochronology.odt>) [PDF] (<https://pressbooks.bccampus.ca/geoglabmanualv2/wp-content/uploads/sites/1340/2021/08/Video-12.4-Transcript-Dendrochronology.pdf>)



One or more interactive elements has been excluded from this version of the text. You can view them online here: <https://pressbooks.bccampus.ca/geoglabmanualv2/?p=193#oembed-4> (#oembed-4)

With this information and your **Key to Common Trees in Pacific Spirit Park** in hand, you should be ready to answer the first few questions in EX3.

Next, proceed to the boardwalk site....

Boardwalk Site

Step 8: Watch Video 12.5.

Video 12.5. Spanish Trail Boardwalk (<https://www.youtube.com/watch?v=YUW1gdGqnFI>). Transcript available: [Word] (<https://pressbooks.bccampus.ca/geoglabmanualv2/wp-content/uploads/sites/1340/2021/08/Video-12.5-Transcript-Boardwalk.docx>) [ODT] (<https://pressbooks.bccampus.ca/geoglabmanualv2/wp-content/uploads/sites/1340/2021/08/Video-12.5-Transcript-Boardwalk.odt>) [PDF] (<https://pressbooks.bccampus.ca/geoglabmanualv2/wp-content/uploads/sites/1340/2021/08/Video-12.5-Transcript-Boardwalk.pdf>)



One or more interactive elements has been excluded from this version of the text. You can view them online here: <https://pressbooks.bccampus.ca/geoglabmanualv2/?p=193#oembed-5> (#oembed-5)

Step 9: Click and drag within 360 Photo 12.4 to explore the Boardwalk site.

360 Photo 12.4. Spanish Trail Boardwalk.



An interactive H5P element has been excluded from this version of the text. You can view it online here: <https://pressbooks.bccampus.ca/geoglabmanualv2/?p=193#h5p-12> (<https://pressbooks.bccampus.ca/geoglabmanualv2/?p=193#h5p-12>)

Based on the information you learned, can you identify the sort of disturbance that occurred here at the boardwalk? How/Why? Hint: What do you know about Canada's national animal (seen on Figure 12.4b)? Can you work out what the effect of this disturbance was on the ecosystem and what sorts of species it facilitated (allowed to live here in its aftermath)?

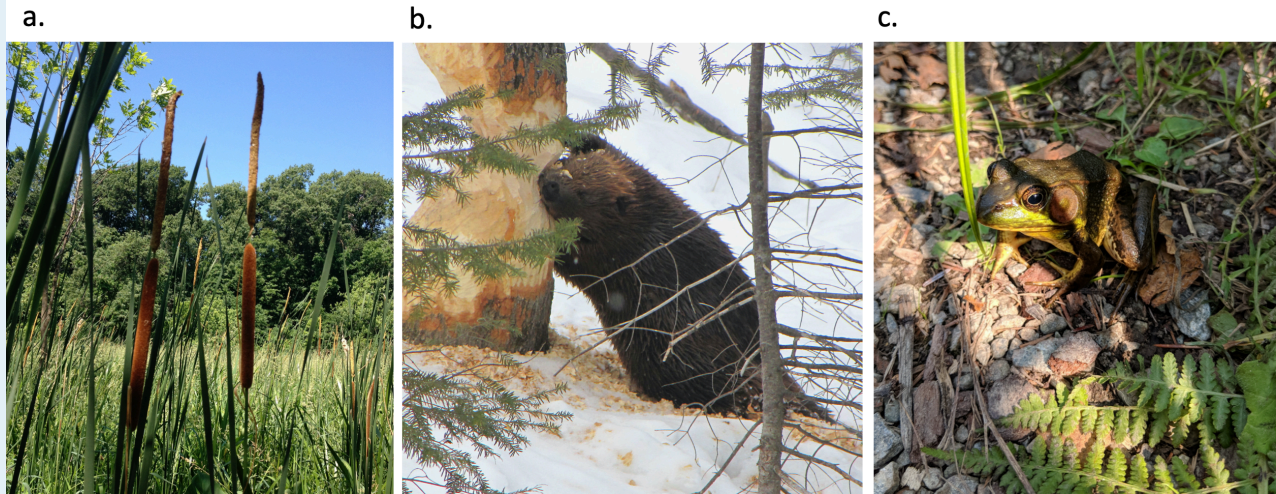


Figure 12.4. Some organisms living at the boardwalk site. a. Narrow-leaved cattail (*Typha angustifolia*). b. American beaver (*Castor canadensis*) cutting a tree in Gatineau Park, Quebec. c. A Green frog (*Lithobates clamitans*) sunning itself near the boardwalk in Pacific Spirit Park. Sources: a. Photo courtesy of Fritzflohrreynolds (2012) [JPG] (https://commons.wikimedia.org/wiki/File:Typha_angustifolia_-_Narrowleaf_Cattail.jpg), CC BY-SA. b. D. Robertson (2010) [JPG] (https://commons.wikimedia.org/wiki/File:American_Beaver,_tree_cutting.jpg), CC BY-SA. c. S. Peng and N. Hewitt (2018), CC BY-NC-SA 4.0.

Entering the Needleleaf Forest and a Look at Some Recently Introduced Species

Step 10: A few steps along from the Boardwalk Site, we arrive at the boundary of the needleleaf forest. Some of the herbaceous vegetation found here is worth examining. Watch Video 12.6 for details and to meet our first example of an invasive species.

Video 12.6. Entering the Needleleaf Forest (<https://www.youtube.com/watch?v=8sMv97zeec8>).

Transcript available: [Word] (<https://pressbooks.bccampus.ca/geoglabmanualv2/wp-content/uploads/sites/1340/2021/08/Video-12.6-Transcript-Entering.docx>) [ODT] (<https://pressbooks.bccampus.ca/geoglabmanualv2/wp-content/uploads/sites/1340/2021/08/Video-12.6-Transcript-Entering.odt>) [PDF] (<https://pressbooks.bccampus.ca/geoglabmanualv2/wp-content/uploads/sites/1340/2021/08/Video-12.6-Transcript-Entering.pdf>)



One or more interactive elements has been excluded from this version of the text. You can view them online here: <https://pressbooks.bccampus.ca/geoglabmanualv2/?p=193#oembed-6> (#oembed-6)

In Video 12.6, a shrub species native to this forest, salal [VIDEO] (<https://youtu.be/Y8mRUAYgi3U>), was highlighted. Find out more about this and other native understory species, including Red huckleberry [VIDEO] (<https://youtu.be/HnTQ6SldvW4>), Sword fern [VIDEO] (https://youtu.be/9ki_w-MqIpg) and Dull Oregon grape [VIDEO] (<https://youtu.be/6VELA3txlN4>) at Coastal Plants of BC (<https://www.youtube.com/channel/UCpQIeCN-XENfiw1RiCaAFqA>), filmed here in Pacific Spirit Park!

Invasive species: Another species highlighted in Video 12.6 is non-native. As you may infer from Figure 12.5, this European invader has been very successful at colonizing the broadleaf forest, with several individuals visible in the photo. Can you think of some adaptations that have made it so successful in this ecosystem?

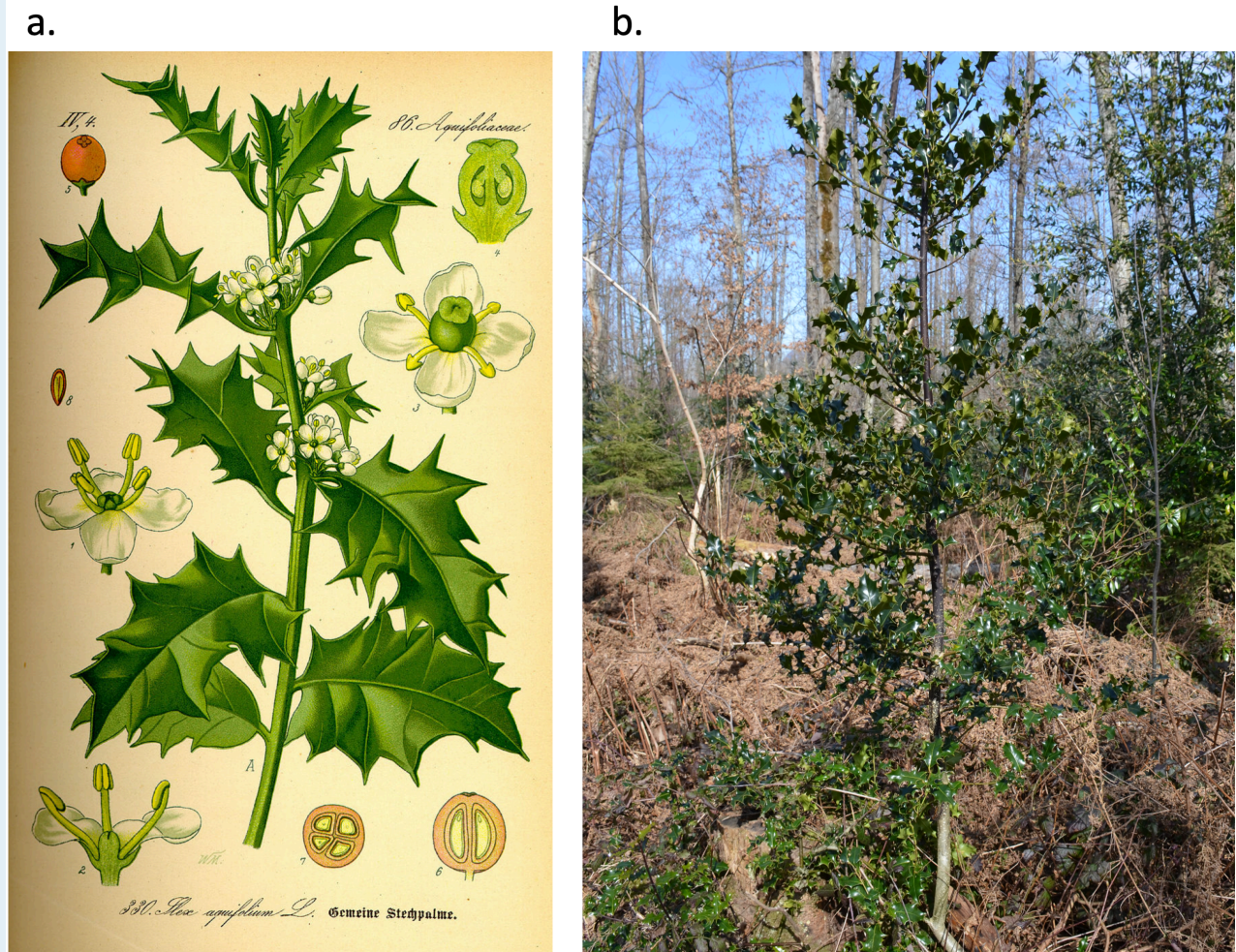


Figure 12.5. a. A botanical illustration of the European invader referred to in Video 12.6. b. The same species growing along the trail. Sources: a. O. Wilhelm Thomé (1885) [JPG] (https://commons.wikimedia.org/wiki/File:Illustration_Ilex_aquifolium0.jpg), Public Domain. b. N. Hewitt (2018), CC BY-NC-SA 4.0.

Another introduced invasive species present in the park is European laurel (*Prunus amygdala*). Note that both of these European invaders are evergreen woody species adapted to environments with mild rainy winters, so they have been introduced in a place with a climate that closely matches their origin. They also produce many berries that animals disperse. If you wish to explore the topic of invasive species, see e-flora BC's Invasive plant species page (<https://ibis.geog.ubc.ca/biodiversity/eflora/invasives.html>).

Stop #2: Needleleaf Forest

Step 11: Watch Video 12.7. This video was filmed in March.

Video 12.7. Needleleaf forest. Transcript available: [Word] (<https://pressbooks.bccampus.ca/geoglabmanualv2/wp-content/uploads/sites/1340/2021/08/Video-12.7-Transcript-Needleleaf.docx>) [ODT] (<https://pressbooks.bccampus.ca/geoglabmanualv2/wp-content/uploads/sites/1340/2021/08/Video-12.7-Transcript-Needleleaf.odt>) [PDF] (<https://pressbooks.bccampus.ca/geoglabmanualv2/wp-content/uploads/sites/1340/2021/08/Video-12.7-Transcript-Needleleaf.pdf>)



One or more interactive elements has been excluded from this version of the text. You can view them online here: <https://pressbooks.bccampus.ca/geoglabmanualv2/?p=193#oembed-7> (#oembed-7)

Step 12: Click and drag within 360 Photo 12.5 to explore the needleleaf forest, Stop 2.

360 Photo 12.5. Needleleaf forest.



An interactive H5P element has been excluded from this version of the text. You can view it online here: <https://pressbooks.bccampus.ca/geoglabmanualv2/?p=193#h5p-15> (<https://pressbooks.bccampus.ca/geoglabmanualv2/?p=193#h5p-15>)

Step 13: For further information about the stand here at Stop #2, see the 360 Video 12.8 filmed later in the season (in June). As this is a 360 video, so you may click and drag within the video to explore the area in 360°.

Video 12.8. Needleleaf forest later in the season (<https://www.youtube.com/watch?v=yKGnnYS84IU>).

Transcript available: [Word] (<https://pressbooks.bccampus.ca/geoglabmanualv2/wp-content/uploads/sites/1340/2021/08/Video-12.8-Transcript-Needleleaf-Later.docx>) [ODT] (<https://pressbooks.bccampus.ca/geoglabmanualv2/wp-content/uploads/sites/1340/2021/08/Video-12.8-Transcript-Needleleaf-Later.odt>) [PDF] (<https://pressbooks.bccampus.ca/geoglabmanualv2/wp-content/uploads/sites/1340/2021/08/Video-12.8-Transcript-Needleleaf-Later.pdf>)



One or more interactive elements has been excluded from this version of the text. You can view them online here: <https://pressbooks.bccampus.ca/geoglabmanualv2/?p=193#oembed-8> (#oembed-8)

You have entered a remnant of a native coastal forest of the kind you identified using BC's BEC System (<https://www.for.gov.bc.ca/hfd/library/documents/treebook/biogeo/biogeo.htm>) in EX1. Notice the larger (and older) canopy trees relative to those in the broadleaf forest, indicating the longer time since major disturbance. This stand established following logging and burning in the 1920s, regenerating naturally thereafter. Planting or seeding later became common practice in clearcut sites in BC.

Consider the kinds of site conditions present here: cool and shady or hot and sunny – which? How do they affect the sorts of species growing here (and visa versa)? Identify the three conifer (needleleaf) species discussed in the video based on their leaves and bark, using your **Key to Common Trees in Pacific Spirit Park**. You will come back to this in EX3.

Other native species in this forest include the small understory *Acer* (maple) species mentioned in Video 12.7. There is also a canopy species of maple with very large leaves (see your key!). The latter large-leaved maple is sort of a co-dominant species in this forest. It is shade-tolerant and reaches the canopy alongside the three conifers in late-successional stands. Find both in your **Key to Common Trees in Pacific Spirit Park**. For precise botanical information on the understory maple species, watch this vine maple video

(<https://www.youtube.com/watch?v=APlgy33IFGI>). Now, you may wish to try this tree species ID knowledge test (<http://blogs.ubc.ca/alpineplants/2020/05/09/match-the-leaves-and-bark-with-the-tree-species/>).

In 360 Photo 12.5, notice the large pile of earth with young hemlock trees (saplings) growing on it along the east side of the trail (opposite from the dog). This is a **tree-fall** or **tip-up mound**, an important micro-habitat and **safe site** for many forest species, including Red huckleberry and Western hemlock. Safe sites refer to areas protected from hazards, such as burial from leaf-litter, that provide suitable conditions (fresh, exposed soil) for species' seed to germinate and establish. These sorts of micro-habitats become more available in complex environments such as this, where forest trees have had time to live out their life cycles, decay, and create a decomposed stump or branch litter, for example.

More about Pacific Spirit Forest, Past and Present

Like the area at Stop 1, this area experienced large-scale human disturbance, but less recently. In this case the large-scale disturbance was extensive logging/tree-cutting. See a photo of what the site must have looked like soon after the disturbance at Clearing the Point Grey Campus (<https://open.library.ubc.ca/collections/arphotos/items/1.0018818>) (1914, UBC Archives). One may assume that the forest today is approaching a size (age) structure and species composition of a late successional stand, perhaps one that more closely resembles the historical forest, common throughout the region prior to colonization. Successional changes have thus proceeded for longer than at Stop 1, and this greater **time since disturbance** helps to explain the difference in species composition and structure between the two sites. That said, it probably lacks the complexity and very large, old (greater than 500 years age) stems that might have occurred otherwise on sites that escaped periodic fires. Figure 12.6 demonstrates the use of an increment borer, which is one tool used to determine the age of trees, and hence date the time of disturbances.



Figure 12.6. a. An increment borer is used to extract a core from the tree pointed out in Video 12.7. b. The teaching team at UBC Geography examines the ring sequence to determine its age. Source: Photos courtesy of K. Pierce and N. Hewitt, CC BY-NC-SA 4.0.

There are other sorts of disturbance here including some more regular, small-scale disturbances. When we take students through this site, we pass some burned out stumps.

Think about the forest before the logging event. It would have supported stems much more massive than those present (Figure 12.7).



Figure 12.7. A larger, older individual of the species cored in Figure 12.6, about to be harvested in Oregon State, over a century ago. Tree-cutters would avoid the broad base of the stem by cutting notches in the trunk about 1 m above the ground, and inserting planks on which to stand (photo taken ca. 1905). Source: J.F. Ford [JPG] (https://commons.wikimedia.org/wiki/File:Logging_oregon.jpg), Public Domain.

Stumps associated with these wide-scale logging events are found throughout Pacific Spirit Forest (Figure 12.8). How do you think the university's extractive forestry practices affected the ecosystem? Would there have been long-term impacts on structure and function? Of course, disturbance and change is a normal feature of ecosystems, but perhaps the scale of destruction from logging operations was atypical? In this sense, this little piece of needleleaf forest represents an altered remnant, and may be illustrative of the **Anthropocene**.



Figure 12.8. One of the many decaying stumps found throughout Pacific Spirit Forest that mark past wide-scale logging events. Note the notches where planks were inserted. This is probably a Western red cedar judging from its broad base. Source: N. Hewitt, CC BY-NC-SA 4.0.

Consider how post-settlement forest practices compare to those of the the $x^w m \theta k^w \dot{a} y \dot{a} m$ (Musqueam), the traditional and ancestral people of Point Grey. One Indigenous practice of forest harvesting, cedar bark stripping, was touched on in the video. This practice is non-destructive: trees survive, gradually sealing off

wood where bark is stripped via cambial tissue growth (growth from cambial cells located just beneath the bark that produce the tree's annual rings). Affected trees retain residual scars that identify them years later, and are referred to as **culturally modified trees (CMT)**.

EX3: Interpret What You Have Seen and Learned

Stop #1: Broadleaf Forest

3. For the dominant tree species, identify the species and give both its common and scientific name. Note: it is scientific protocol to either underline or italicize scientific names. Genus names are capitalized and the species names are lower case.
 - a. Common name of the dominant tree.
 - b. Scientific name of the dominant tree.
4. List two diagnostic features from the **Key to Common Trees in Pacific Spirit Park** in the Supporting Material that you found most helpful to identify the dominant tree species.
5. What was the main disturbance that initiated this broadleaf forest?
6. Based on your observations, list two other disturbances (besides the hiking trail) that appear likely to have occurred in this forest. Provide evidence for each one.
7. Name the pioneer tree species in this forest and describe at least two specific attributes (adaptations) that help it to be an effective pioneer species.
8. Based on your observations, how might the broadleaf forest change in the future, assuming it continues to undergo succession without any further major disturbances? State two possible ways the forest might change or develop.
9. The trees in this forest are deciduous and lose their leaves each autumn. Do leaves contribute to organic soil horizons, mineral soil horizons, or both? Briefly explain your answer.

Stop #2: Needleleaf Forest

10. Use the **Key to Common Trees in Pacific Spirit Park** in the Supporting Material to identify three common tree species in the needleleaf forest. Give both their common and scientific names. Explain at least one diagnostic feature you found most useful in identifying each. These could be features mentioned in Video 12.7 or observed on the specimens and seen in the key.
11. Name the two maple species discussed at Stop 2 and mentioned in the **Key to Common Trees in Pacific Spirit Park**, and in Video 12.7. Identify which is a small understory species and which is emergent, in the canopy.
12. Name the dominant species (one or potentially more) in the needleleaf forest. Briefly explain what information you based this assertion on. That is, what did you observe in Video 12.7 and/or 360 Photo 12.5 to suggest that this was the case?
13. Based on your observations, list two disturbances that have occurred in this forest and explain why you listed these. What information did you notice/draw on?

Important: Were we to continue down the trail a few metres, we would arrive at the site of a charred tree stump. Other sorts of small- and large- scale forest ecosystem disturbance types are discussed in your course readings and in NRCan – How does disturbance shape Canada’s forests? (<https://www.nrcan.gc.ca/our-natural-resources/forests-forestry/disturbance-canadas-forests/16502>) (in particular, the literature cited list).

14. In the needleleaf forest stand we touched on a few characteristics, or **ecosystem properties**, that occur in these less-recently disturbed sites, and are important from a biodiversity standpoint. Describe one characteristic/property and explain why it matters from an ecosystem or biodiversity standpoint.
15. If disturbance occurs and creates large canopy openings, which tree species do you predict will colonize the openings? Justify your choice. **Hint:** There are two possibilities. One of them is growing in the canopy at this site, and acts as a sort of **pioneer species** in large openings in this otherwise mature forest.

Questions 1-4, 6-8,10, and 11 are adapted from UBC Geography (2019).

EX4: Self-Guided Plant Identification in Your Location

Safety note: do NOT complete this exercise until receiving a safety briefing and filing the proper paperwork (if applicable). Your first responsibility when arriving at a site is to ascertain whether or not the terrain is safe to traverse. If not, find a new location.

Get to know some of the species of trees growing near you by identifying **two species** in your immediate landscape. You may find the trees in a garden, along your street, in a park or nature preserve or in an outdoor recreational area you visit.

Tips for finding species information:

- The **Key to Common Trees in Pacific Spirit Park** (or **Pictorial Key to Common Trees in Pacific Spirit Park**, both in the Supporting Material) will assist you in distinguishing needleleaf and broadleaf species, but if you are not in BC, the taxa will differ at the species and possibly genus level.
- If you are unable to determine species’ identity with reference to online guides, take a photo with your phone and use one of several apps, including iNaturalist (download from: Google Playstore (https://play.google.com/store/apps/details?id=org.inaturalist.android&hl=en_CA); App store (<https://apps.apple.com/us/app/inaturalist/id421397028>)) to identify it.
- To find whether native or non-native to your region, there are many online sites such as e-flora (here for E-Flora BC (<https://ibis.geog.ubc.ca/biodiversity/eflora/>); or search for other parts of the world using scientific or common names). Wikipedia is often reliable (though no guarantees with crowd-sourced information!). If you have trouble finding information, ask your instructor for assistance.

Step 1: Find species.

Criteria to look for:

- Tree species (not shrubs/herbs/ferns).
- At least one should be a coniferous/needleleaf species. See your **Key to Common Trees in Pacific Spirit Park** to ensure you find one.
- At least one should be a broadleaf/hardwood tree. See dichotomous key for indicators. **Note that a common street tree in North America, and native to Asia, *Ginkgo biloba*, is not a broadleaf/ hardwood (angiosperm)—it is taxonomically related to needleleaf/ conifer (gymnosperm) species, but its appearance is deceiving!**

Step 2: Identify and document your species.

List the names, both scientific and common, for each of your species and take a photo of the leaves and bark/ any cones or flowers/seeds to include in your submission.

Step 3: Indicate the species' origin.

State whether each species is native to your location or non-native and if the latter, where it originates.

Step 4: Estimate its commonness/abundance in the local landscape.

State whether it is one you have noticed frequently in which case it may be labelled abundant/common in your location, whether it is not common, or you **don't know** (since this information is often complicated by human land management and cultivation practices and may not be easily determined).

Step 5: Note other relevant details.

Some details that might apply include:

- Is the individual you saw cultivated (planted) or wild (recruited naturally)?
- If the species are native to your area, can you specify its niche or role in the local ecosystem?
- If non-native, how do you think it got there—intentionally (brought in to be planted/cultivated) or unintentionally? Provide brief notes to explain your reasoning.

Step 6: Species Summary

Combine the information you gathered in Steps 1-5 into one short paragraph per species. Insert photos of each species, making sure that you give each photo a descriptive caption.

Reflection Questions

1. How did the species you identified in the needleleaf forest compare to those you noted from the ecosystem classification for this BEC zone in EX1? How did the species composition differ? Indicate any species in the BEC zone description that were present and ones were absent or in addition to what you had expected. What might account for these differences? Consider ecosystem controls, and factors that determine plant populations. Note that **randomness** is a factor influencing plant populations and patterns of species distribution!
2. One of the woody species we glimpsed in both forest types is an introduced species (see Video 12.6, filmed as we enter the needleleaf forest). It is known for its evergreen leaves with pointed

edges and for its red fruits. Use the key to identify this species. Name the species and state which world region it originated from. You also learned of at least one other introduced species on the tour. What impact do these sorts of invasive species have on native species in the forest? What actions do you think could be taken to manage invasive species and the threat they pose to biodiversity? (one paragraph with the species information and your thoughts)

Supporting Material

Keys to Common Trees in Pacific Spirit Park

Text version – recommended

- Key to Common Trees in Pacific Spirit Park [WORD] (<https://pressbooks.bccampus.ca/geoglabmanualv2/wp-content/uploads/sites/1340/2020/07/Key-to-Common-Trees-in-PSPv1.docx>)
- Key to Common Trees in Pacific Spirit Park [ODT] (<https://pressbooks.bccampus.ca/geoglabmanualv2/wp-content/uploads/sites/1340/2020/07/Key-to-Common-Trees-in-PSPv1.odt>)
- Key to Common Trees in Pacific Spirit Park [PDF] (<https://pressbooks.bccampus.ca/geoglabmanualv2/wp-content/uploads/sites/1340/2020/07/Key-to-Common-Trees-in-PSPv1.pdf>)

Pictorial version

- Pictorial Key to Common Trees in Pacific Spirit Park [PDF] (<https://pressbooks.bccampus.ca/geoglabmanualv2/wp-content/uploads/sites/1340/2020/07/Pictorial-Key-to-Common-Trees-in-PSPv1.pdf>)

References

- Hewitt, N. (2018). Chapter 10: Plant geography. In A. F. Arbogast, L. Ford, & D. Dagesse, *Discovering physical geography, First Canadian edition*. John Wiley & Sons.
- Johnson, E.A., & K. Miyanishi. (2008). Testing the assumptions of chronosequences in succession. *Ecology Letters*, 11, 419-431.
- Klinkenberg, B. (2020). Invasive Plant Species. In: B. Klinkenberg, Brian (Ed.), *E-Flora BC: Electronic atlas of the flora of British Columbia*. Lab for Advanced Spatial Analysis, Department of Geography, University of British Columbia. <https://ibis.geog.ubc.ca/biodiversity/eflora/>
- Leishman, M. (2001). Does the seed size/number trade-off model determine plant community

structure? An assessment of the model mechanisms and their generality. *Oikos*, 93(2) 294-302.
<https://www.jstor.org/stable/3547307>

Straley, G.B., & R.P. Harrison. (1987). An illustrated flora of the university endowment lands.
Botanical Garden Technical Bulletin, 12. University of British Columbia.

UBC Geography. (2019). Lab 4 handout: Soils, tree species composition and disturbance history in
pacific spirit park. In *GEOB 102, Our Changing Environment: Climate and Ecosystems* Dept. of
Geog., University of British Columbia.

Media Attributions

- 1 Introduction to Pacific Spirit Forest Tour along Spanish Trail (<https://www.youtube.com/watch?v=3Q9PaUpntSQ>) by Hewitt Lab (<https://www.youtube.com/channel/UCs3OpjdlF1-HPU29FBjZbGQ>) is licensed under a CC BY licence (<https://creativecommons.org/licenses/by/4.0/>).
- 2. Video in Hardwood forest, Pacific Spirit_Stop 1 (<https://www.youtube.com/watch?v=iLWIKuhMkls>) by Hewitt Lab (<https://www.youtube.com/channel/UCs3OpjdlF1-HPU29FBjZbGQ>) is licensed under a CC BY licence (<https://creativecommons.org/licenses/by/4.0/>).
- UBC GEOB 102 TA Interprets the Forest Structure and Signs of Change (https://www.youtube.com/watch?v=7hs_yfNmnzs) by Hewitt Lab (<https://www.youtube.com/channel/UCs3OpjdlF1-HPU29FBjZbGQ>) is licensed under a Standard YouTube License.
- Dendrochronology: A tool to date past disturbance events (<https://www.youtube.com/watch?v=OQQaeZ05u7c>) by Hewitt Lab (<https://www.youtube.com/channel/UCs3OpjdlF1-HPU29FBjZbGQ>) is licensed under a CC BY licence (<https://creativecommons.org/licenses/by/4.0/>).
- 3. Video on the Boardwalk of Spanish Trail (<https://www.youtube.com/watch?v=9y1W7OKJtMw>) by Hewitt Lab (<https://www.youtube.com/channel/UCs3OpjdlF1-HPU29FBjZbGQ>) is licensed under a CC BY licence (<https://creativecommons.org/licenses/by/4.0/>).
- 4. Video Entering the Needle-leaf (Conifer) Forest (<https://www.youtube.com/watch?v=8sMv97zeec8>) by Hewitt Lab (<https://www.youtube.com/channel/UCs3OpjdlF1-HPU29FBjZbGQ>) is licensed under a CC BY licence (<https://creativecommons.org/licenses/by/4.0/>).
- Video in the Needle-leaf Forest, Stop 2 (<https://www.youtube.com/watch?v=bpMtvW3Xrxo>) by Hewitt Lab (<https://www.youtube.com/channel/UCs3OpjdlF1-HPU29FBjZbGQ>) is licensed under a CC BY licence (<https://creativecommons.org/licenses/by/4.0/>).
- Needleleaf Forest, Pacific Spirit, June 2020 (<https://www.youtube.com/watch?v=yKGnnYS84IU>) by Hewitt Lab (<https://www.youtube.com/channel/UCs3OpjdlF1-HPU29FBjZbGQ>) is licensed under a CC BY licence (<https://creativecommons.org/licenses/by/4.0/>).

Image Descriptions

Figure 12.1. Diagram of the structure of a forest and its layers

A schematic diagram of the structure of an eastern deciduous forest and its layers.

- Ground layer: at the bottom is the ground layer consisting of soil, rock, and material found within and associated with the soil.
- Herb layer: moving upwards, the next layer is the herb layer, which consists of vegetation that lies low to the ground.
- Shrub layer: the third layer is the shrub layer which consists plants with structures that allow them to grow taller than the plants that grow immediately on the surface.
- Tree layer: the fourth and final layer is the tree layer, which is the top of this schematic. Trees are vegetation with strong woody structures that allow them to grow taller than the low-lying vegetation. The trees that are shown in the diagram from left to right are: a sugar maple (with a vine growing on it), an eastern hemlock, a flowering dogwood, a trembling aspen, and an American beech.

[Return to Figure 12.1]

Lab 13: GPS Orienting

Stuart MacKinnon and Craig Nichol

Geospatial information is important to anyone wanting to analyze the spatial configuration of Earth's surface, including those features that are natural (e.g., rivers, lakes, mountains) or human-made (e.g., streets, buildings). **Geospatial Information Science (GIS)** is the discipline that deals with geospatial information. **Geographic information systems (GIS)** are software programs designed to work with geospatial data. Over the last two decades, GIS have become ever more powerful and widely used in day-to-day life. This exercise will allow you to become familiar with a couple of the most frequently used geospatial programs: Google Maps and Google Earth.

This lab provides experience in using Google Maps to navigate a route and record GPS coordinates, and using Google Earth (Web) to produce point location stops with photographs and add a path to outline the route taken on the produced tour.

Learning Objectives

After completion of this lab, you will be able to

- Use Google Maps to obtain coordinates for stops of interest (i.e., waypoints).
- Pin waypoints in Google Earth (Web) using the coordinates obtained with GPS.
- Import and attach photographs to Google Earth (Web) pins.
- Translate a walked route from Google Maps into Google Earth (Web).
- Exhibit a subject of interest as a virtual tour in Google Earth (Web).

Pre-Readings

In order to complete this lab, some background information in digital positioning systems, mapping with a smartphone, geographical information systems, and using Google Earth web is required.

Digital Positioning Systems

Locating yourself on Earth has become much simpler since the creation of digital positioning systems. The most well-known of these is the satellite-based **Global Positioning System**, more commonly known as **GPS**. The core of the GPS system is composed of dozens of satellites that orbit Earth at 20,000 km altitude. Each satellite has a precisely synchronized clock on board, and the satellites are constantly tracked so their precise position is known at any instant in time.

The satellites emit a time-coordinated signal that can be detected by a GPS receiver on Earth. Receivers track the signal from multiple satellites at once: 4 or more are needed for best accuracy. The timing of when that signal left the satellite, and the position of each satellite when the signal was sent is known and available to the receiver. The distance from each satellite to the receiver is calculated using the time offset between when the signal arrives from the each of the different satellites, and the velocity of those signals in the atmosphere. A spherical surface of radius L can be defined that includes all points in space that are at the same distance away from that satellite. (This is why having only one satellite would not be much use.) Knowing the distance between the ground-based receiver and multiple satellites allows you to calculate the location where all the spheres intersect, and this represents the receiver location (Figure 13.1).

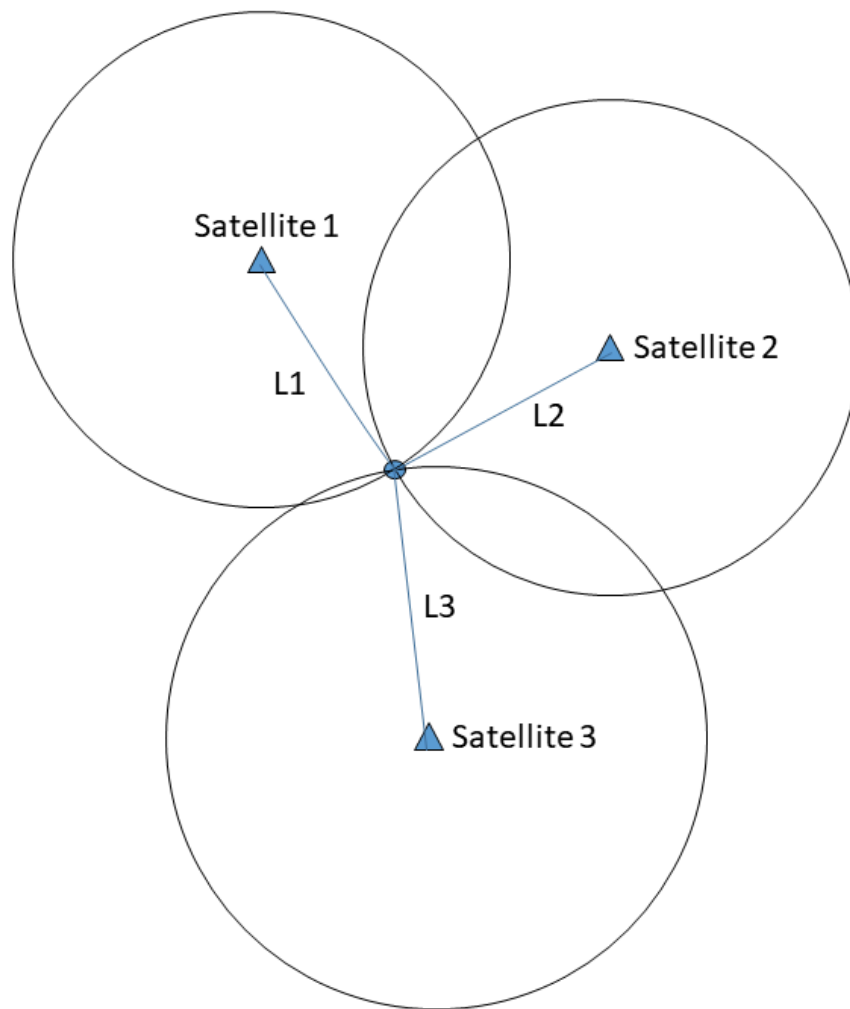


Figure 13.1. Locating a point on Earth as being the distance $L1$ from Satellite 1, distance $L2$ from Satellite 2, and distance $L3$ from Satellite 3. Note that this is a 2D rendering of a 3D arrangement in space. Source: C. Nichol, CC BY-NC-SA 4.0.

The GPS system relies upon the receiver having a default model of the atmosphere in order to calculate distances. Variations in the properties of the atmosphere at any given moment cause slight errors in the calculations, but with multiple satellites, the location of the receiver can be determined to about 5 to 10

m accuracy. Greater accuracy can be achieved with high-quality receivers, but requires considerable post-processing of the data to account for atmospheric effects.

The accuracy of the basic satellite system was improved by deploying a number of permanent land-based receivers to provide wide area corrections. These base stations have exact coordinates that are fixed and precisely known (Figure 13.2).

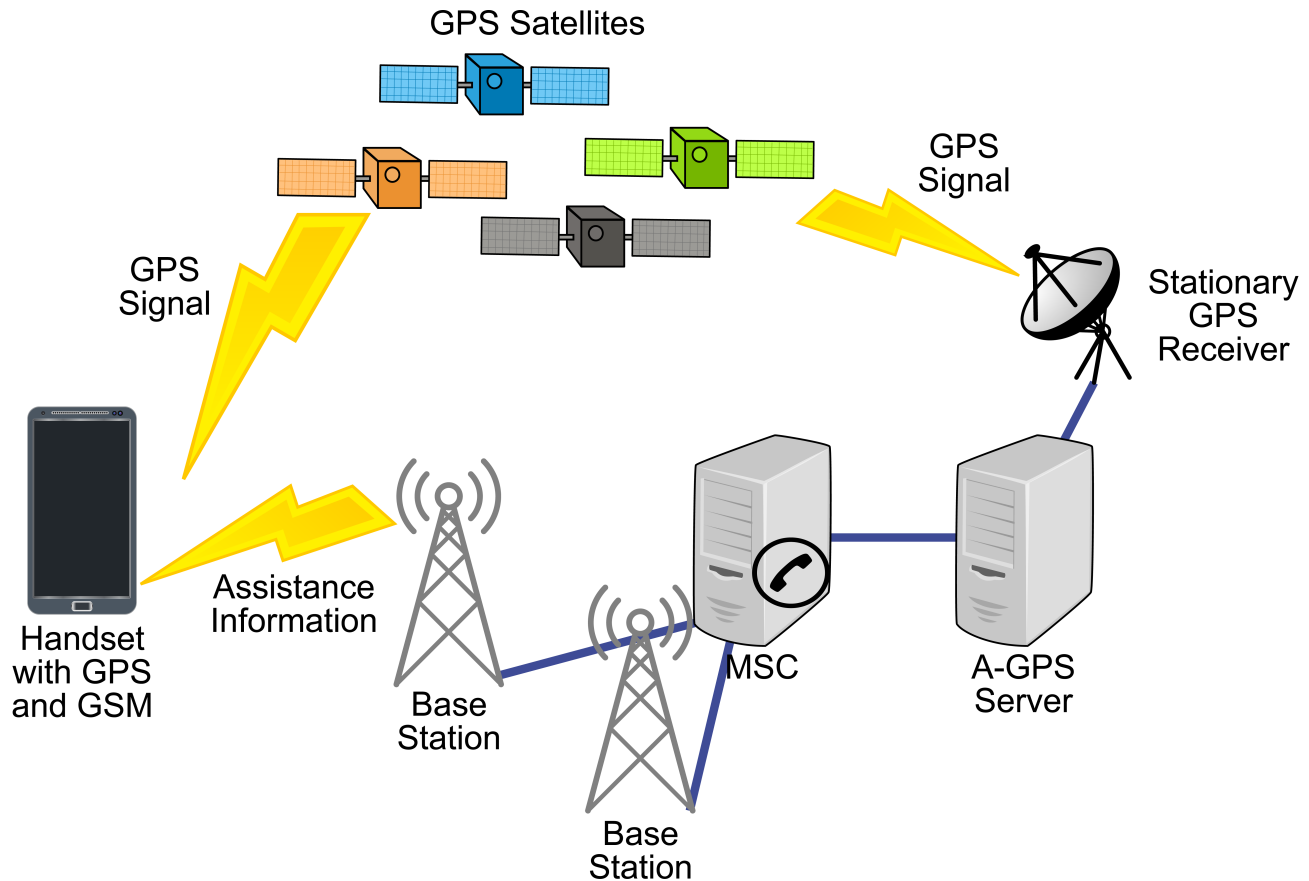


Figure 13.2. Schematic representation of the correction data provided to GPS receivers by GPS ground stations and servers. Source: Adlerweb (2017) [SVG] (<https://commons.wikimedia.org/wiki/File:A-GPS.svg>), Public Domain. [Image description]

The ground base stations determine their calculated coordinates based on GPS signals, and powerful comput

ers then determine the offset between the GPS calculated location and the actual known location. The data are broadcast as corrections to nearby receivers in real time (i.e., almost instantaneously). For example, if the GPS signal at the base station determines coordinates that put it 1 m to the east of its known location, then the GPS system distributes a message to all local receivers that any coordinates being calculated right now should be corrected by 1 m to the west before being shown to the user. This compensates automatically for atmospheric distortions of the satellite communication signals due to clouds, inversions, and storms, for example.

There are around 50 base stations in North America, which means a user might be 100s of kilometers or more from the nearest station. The corrections are more accurate close to the station, but a typical hand-held receiver may achieve ~1m accuracy with such wide area correction, if available.

The most accurate GPS systems are known as **differential GPS systems**. These use a ground receiver located within at most a few kilometers of the high-accuracy mobile receiver. Atmospheric corrections are made in real time for local conditions close to the receiver that allows locations to be obtained to within centimeters or sometimes better.

Mapping with a Smartphone

Your smartphone or tablet typically contains a GPS receiver that is likely of a slightly lower quality than a dedicated handheld GPS receiver. Cellular devices also use other means to locate themselves, such as pings to nearby cellular towers installed by the telecommunications provider. The towers transmit at known powers, and each cellular device has a known power of transmission. The variation in signal strength between the device and the towers can be used to estimate the distance from each tower.

Similar to the GPS satellites, the estimated distance from each cell tower defines a sphere around the tower, and the intersection of those spheres locates the transmitting device via triangulation. In some cases, the time of travel of signals from a phone to different towers can also be used to estimate distances in the same way as GPS data.

There can be complications, however. Buildings in urban areas and other parts of the built environment can block, reflect or alter signals. In cities, cell towers may be able to locate a cellular device to within 50 m from signal strength. Outside of cities, multiple towers may be far apart and accuracy is lower, or only one tower may be available, and no detailed location can be determined other than an estimated distance range from the tower.

Smartphone Location Settings

You will be mapping locations in the field during the lab using mapping software built into your mobile device. Make sure that you have determined how to turn on and off your device's location settings. In Android, it is under your main device settings. In some versions **Location** is there as a setting. In other versions, you may have to look under **Biometric and Security**. You may also be able to swipe down from the top of your screen to access a quick link to turn location services on and off. On Apple devices, **Location Services** is found in **Settings** → **Privacy**. Typically, when you turn on any mapping app such as Google Maps, you will be prompted to turn on your location service, in which case you won't need to search in your settings to turn on your GPS.

Software

Spatial mapping software is a common feature of most smartphones for providing directions. The two most commonly used programs for navigating are Google Maps and Apple Maps. Google Maps operates on all smartphone operating systems and therefore will be the software package we use for the lab.

Prior to the lab, download the Google Maps app to your smart device. Take some time to experiment with Google Maps before the start of the lab. There are a wide range of introductory Google Maps tutorials on the web to help you practice the following:

- Opening Google Maps in map view (the default view).
- Typing in an address and asking for walking (pedestrian symbol) and driving (car symbol) directions from where you are.
- Typing in a feature and asking for directions on public transit from where you are. Look for the bus icon. Which bus should you take? How long does it take?
- Searching for a category of things. For example, search **Grocery Store**.
- Switching to satellite view and back to map view. Take some time to scroll around where you live using the satellite view. Can you find any forested areas?
- Dropping a pin at a location. On a smartphone, this involves pressing and holding on a chosen location.

We will use this last skill in the lab, and you can experiment with this prior to the lab. To mark a point:

1. Zoom in to the location where you wish to mark a point. Do this by pinching two fingers in to zoom out, and apart to zoom in.
2. Place your finger on the location you wish to mark, and hold it until a **Pin** is dropped on that location.
3. The latitude and longitude of the location in decimal degrees will be displayed in the top menu bar. These can be written down.
4. The point can be shared with yourself by clicking on the share icon. You can email or text the point in order to keep it.
5. You can click on **Label**, choose a name for the point and then save the point to your device.

Geographical Information Systems (GIS)

Cartographers are routinely faced with trying to reconcile different datums, spheroids, old maps, new maps, GPS data, and survey data, all using hand calculations. Even with powerful computers, the task is complex and arduous. The evolution of Geographic Information Systems (GIS) has hugely simplified such routine tasks as coordinate transformations and has opened up new ways of mapping features and processes on Earth's surface.

GIS comprise both the hardware and software that are fundamental to the mapping enterprise, but it is increasingly common for people to use **GIS** generically in reference to the class of computer program that are available for use. For example, Google Earth, ARC GIS, and QGIS are three of the most commonly used GIS programs, but there are several others (e.g., GRASS).

These systems are capable of storing **spatial coordinates** (in all their varying forms and coordinate systems) as well as any **attributes** associated with that location. For example, when taking a hike in the woods, you may come across an earthen mound that you suspect contains artifacts of interest to First Nations. Rather than disturb the site, you take a waypoint (i.e. the coordinates of the site) and enter a note describing the feature as an **earthen mound possibly containing artifacts** then upload a photo. The note and photo are attributes rather than coordinates.

How GIS Store Spatial Information

GIS systems are based on storing spatial data using three fundamental data types: points, lines, and polygons.

A **point** is a single location in space defined by a set of coordinates (Figure 13.3, left). We will be using latitude and longitude expressed in decimal degrees, and elevation (in metres). Each point can have attributes that are associated with that single point and stored in a data table.

A **line** is formed by connecting a series of points (Figure 13.3, middle). The line that connects the points can be straight line segments or interpolated curves. The attributes are associated with all locations along the line, not just the points. The term **polyline** is often used because the line does not necessarily have to be continuous (Figure 13.3, right). Data stored in the table of attributes can be in multiple formats: integers, real numbers, text, images, etc.

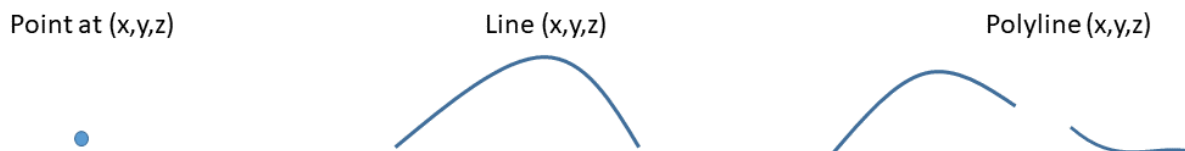


Figure 13.3. The three ways that GIS store spatial information: points, lines, and polylines. Source: C. Nichol, CC BY-NC-SA 4.0.

A **polygon** is a closed shape formed by connecting a series of points. A polygon can define a two-dimensional shape where the shape is defined in **x** and **y** coordinates only (Figure 13.4). If the world was flat, then the length and width in map view (looking down from above) would be the same as the length and width on the ground.

Map View: Looking vertically downwards.
 A. 2-D Polygon points at same elevation.

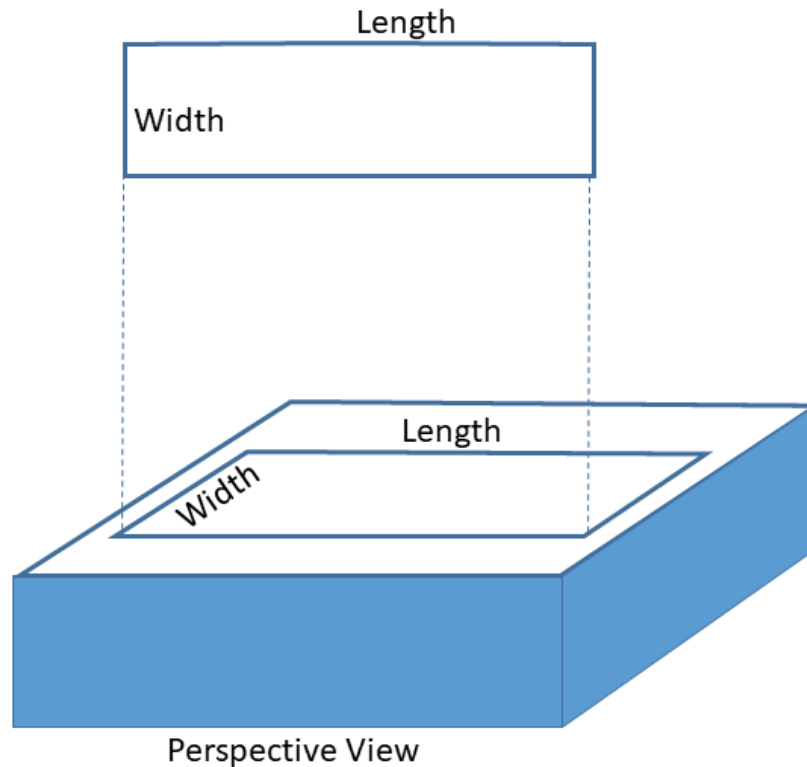


Figure 13.4. Two-dimensional polygon in map and perspective view. Source: C. Nichol, CC BY-NC-SA 4.0.

A **three-dimensional polygon** requires that **x (longitude)**, **y (latitude)**, and **z (elevation)** coordinates be entered for each point. One way to do this is to define coordinates in **x** and **y** only, and then let the geographic information system assign the elevation coordinate to be equal to the ground surface elevation that it has stored in some other way (Figure 13.5). This is a common way to make polygons in Google Earth. In the example shown, the size of the rectangular polygon is defined first in **x** and **y** only in a Map View, and it has a length and width in this example. The length and width on the ground (denoted **length'** (pronounced **length prime**) and **width'** (pronounced **width prime**)) will be different because the polygon has a **z** dimension to it. When you measure the area of the polygon, it is important to know which area you need: map-view 2D area, or on-the-ground 3D area.

Map View: Looking vertically downwards.

Polygon points at different elevations by fixing them to ground surface for their z elevation.

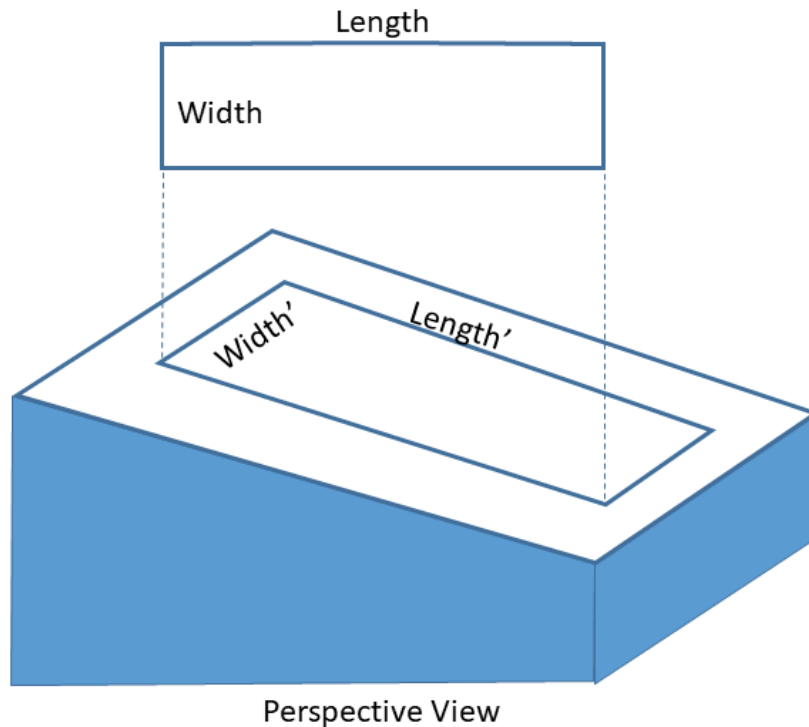


Figure 13.5. Three-dimensional polygon in map and perspective view, where elevation is set to be equal to ground surface. Source: C. Nichol, CC BY-NC-SA 4.0.

Three-dimensional polygons can also be created by assigning x , y , and z coordinates to the polygon right from the start (Figure 13.6). The GIS system starts with the full 3D data seen in the perspective view ($length'$, $width'$). It can project this onto the map view to determine what the polygon shape looks like if you are looking directly downwards. It is important to understand what area is being calculated when you request an area value: the area of the polygon in map view ($length$ multiplied by $width$), or the actual area defined on the ground ($length'$ multiplied by $width'$), which could be larger depending on topography.

Map View: Looking vertically downwards.

3-D Polygon points defined by x , y and z elevations.
e.g.: a top of buried underground geology layer

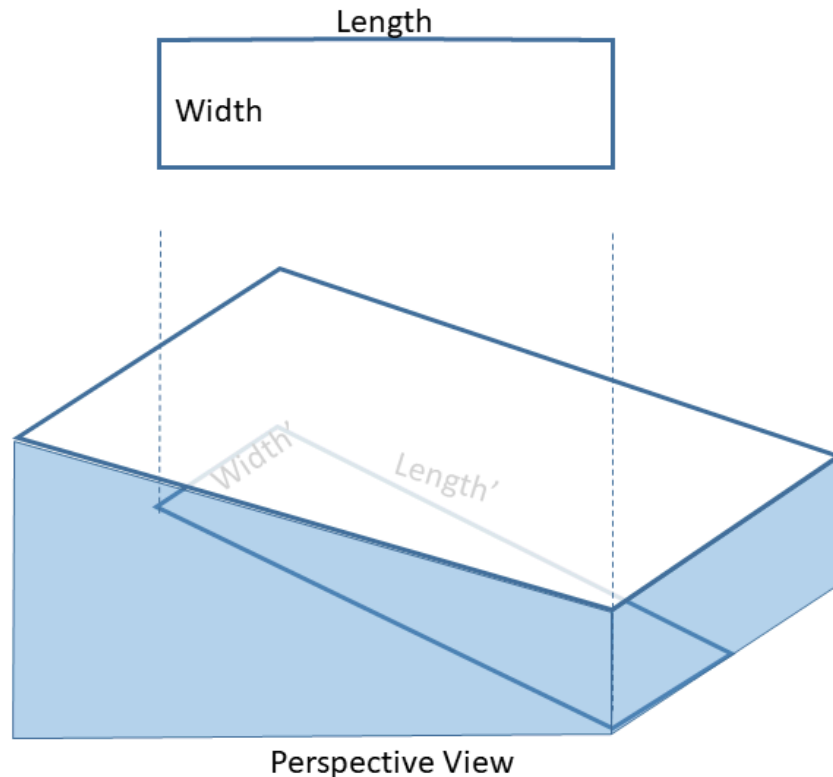


Figure 13.6. Three dimensional polygon with x , y , and z coordinates specified at each vertex (corner) of the polygon. Source: C. Nichol, CC BY-NC-SA 4.0.

Using Google Earth (Web)

Like Google Maps, Google Earth was created to be very user friendly. It does not require specialized knowledge, and basic mapping functions are fairly intuitive. However, both programs have very sophisticated GIS capabilities behind them that can be used in ways similar to QGIS or ARCGIS.

There is a traditional desktop version of the program that can be downloaded and installed on your computer, but we will be using the online version: Google Earth (Web) (<http://www.google.com/earth>). This does not require you to download anything; you simply need to have internet access on your computer. Although it is now possible to run the web version of Google Earth in most internet browsers, Google Chrome is the recommended browser.

Refer to Video 13.1 for a thorough, but slightly outdated, tutorial that covers all of the basic functions of Google Earth (Web).

Video 13.1. Basic functions of Google Earth (Web) (https://www.youtube.com/watch?v=hz_RfDbHwr8).



One or more interactive elements has been excluded from this version of the text. You can view them online here: <https://pressbooks.bccampus.ca/geoglabmanualv2/?p=236#oembed-1> (#oembed-1)

It is likely easiest to open Google Earth in Google Chrome on a computer, but then watch the video on your mobile device so you can follow along. Alternatively, a large monitor or dual monitors may allow you to split the screen and have both the video and a Google Earth window open at the same time.

Make sure you are familiar with:

- Zooming in and out using the mouse wheel or the on-screen sliders.
- Panning using either **grab and move** with the mouse, or the on-screen pan tool.
- Tilting the view using the on-screen view.
- Determining the coordinates of the point your mouse is pointing to. To do this, look along the bottom of the screen.
- Measuring the elevation of the ground.
- Determining the elevation of your **eye height**.
- Turning on and off items in the places or layers menus to the left.

The lab exercises will require you to enter point coordinates as pins, add a path, and import and attach photographs to the pins.

Lab Exercises

In this lab, you will be producing a local photograph tour of a subject of interest to you. This will involve going outside near where you live (or elsewhere) and taking photographs and GPS coordinates of a number of spots that demonstrate your subject of interest. Then, you will upload the coordinates and photographs as points in Google Earth (Web). Lastly, you will add a path between points to reproduce the route for your tour. The lab should take 2-3 hours to complete, including approximately 1 hour outside.

The lab requires a smartphone (Android, iOS, Windows) with a data plan and Google Maps installed. If you do not have a smartphone and/or you do not have an active data plan, contact your instructor to arrange for an appropriate modification to the lab exercises based on what technology you do have access to.

EX1: Field Collection of Coordinates and Photographs

Safety note: do NOT complete this exercise until receiving a safety briefing and filing the proper paperwork (if applicable). Your first responsibility when arriving at a site is to ascertain whether or not the terrain is safe to traverse. If not, find a new location.

Step 1: Choose a subject of interest.

This lab is an opportunity to show off a subject that interests you. The restrictions are that the subject has to be found outside, within walking distance of where you live (or within a reasonable travelling distance, if you are willing to travel), and there must be 5-10 points that can be taken at different spots as part of your subject of interest. The points cannot be too close (you cannot use 7 trees in a row) but must be close enough that you can reasonably walk between them.

The following lists some suggestions for points of interest. The suggestions are intended to help you come up with your own ideas, but they can be used if you cannot think of anything else.

- Parks and green spaces that are within walking distance (5+)
- Your favourite walking/hiking trail and points of attractions
- Good nature and/or bird watching sites in your local area
- Bus stops, coffee shops, or bookstores (5+ stops, a better option in cities)
- Different tree and/or plant species that can be found nearby
- Best places to eat that are in your local area (better option in cities)

Step 2: Do some online research (optional).

If you pick a subject of interest that you know little about, spend a bit of time researching it online before heading outside. After you have researched the subject a bit, open Google Maps on your computer or smartphone before wandering outside, and look for your address and potential stop points.

If you have chosen something you are already familiar with (i.e., you are looking at birds in your community and you bird watch daily), this step can be skipped.

Step 3: Prepare your field notes.

Open the Field Notes Template in Worksheets. The provided template includes a table for recording your stop descriptions and point coordinates, and a space for a field sketch of your route. This page can either be printed out, or reproduced on paper you have on hand. Make sure you have this ready to go **before** going outside.

Step 4: Locate and go to your first stop. Collect coordinates, notes, and a photograph.

Once you are at your first stop, open Google Maps on your mobile device. (Make sure the data option is enabled if you don't have this set as the default). You should see the location that you are at. As a reminder, mark a point at your current location:

1. Zoom in to the location where you wish to mark a point. Do this by pinching two fingers in to zoom out, and apart to zoom in.
2. Place your finger on the location you wish to mark, and hold it until a **Pin** is dropped on that location.

3. The latitude and longitude of the location in decimal degrees will be displayed in the top menu bar. Write this down on your field notes.
4. The point can be shared with yourself by clicking on the share icon. You can email, or text the point in order to keep it.
5. Click on **Label** and choose a name for the point, and then save it to your device.

Record a description of your point and the latitude and longitude on your field notes. Then take a photograph of the subject of interest at this stop in **landscape orientation**. It is recommended that you take multiple photographs so you can select the best one later.

Step 5: Repeat Step 3 for the remainder of your stops.

Go to the second stop and collect coordinates and a photograph, then go the third stop and collect coordinates and a photograph, and so on. You need to have a minimum of 5 stops (a maximum of 10), and they need to be within a reasonable walking distance of each other, but not too close. If you can throw a ball between stops, they are too close.

Step 6: At your final stop, produce your field sketch.

Produce a field sketch of your route, including all of the stops. Since you have **pinned** your stops on Google Maps, you can zoom out and see them all at once. This will help with the general shape of your route, and relative distances between each stop. Your field sketch should also include a point of reference. A good point of reference is something that would show up on Google Maps or Google Earth if searched for, like a named school, library, or park. Your field sketch must be completed outside, and you are **not** permitted to reproduce it once inside. An example of a field sketch is provided in Lab 01 Figure 1.3.

Before leaving the field, take the following two photos:

1. A close-up of your field sketch.
2. A selfie of you and your field sketch in front of your final stop of interest.

Step 7: Return home.

Upload the photos of your stops and your field sketch to your computer and save to a known location. Submit the field sketch according to instructions provided by your instructor.

EX2: Producing Your Virtual Field Trip in Google Earth

Step 1: Set up Google Earth (Web).

Even if you are familiar with Google Earth – do NOT skip this step.

Open Google Earth (Web) (<https://www.google.com/earth/>) in your internet browser (Google Chrome is recommended) and click **Launch Earth** in the top right corner.

Click the three horizontal lines on the top of the left hand menu to open the primary Google Earth menu. Click **Settings** to open the settings menu. Scroll down and make sure **Units of measurement** is set to **Meters and kilometers**. Change to this setting if it is not. Then, change **Latitude/Longitude formatting** to **Decimal**. Click **Save**.

We now have Google Earth (Web) set up the way we wish and are ready to enter data.

Step 2: Create your stops as points (placemarks) and upload photographs and descriptions.

If you have not done so yet, email yourself the photographs from your field walk-around and save them on your computer. Make sure to label the photographs so you can attach them to the correct stop numbers.

In Google Earth, the fifth button from the top on the left hand menu looks like a pin over top of a square. Click this icon and a dialog window will pop up to **Make a new project**. Click **Create** and then **Create KML file**. If prompted with a pop up asking if you allow Google to save to your computer, you need to allow it.

Click the pencil icon and enter **Lab 13 <your name>** as your project name, then enter a short description about what your subject of interest is and the general location where you completed the project. Click **Enter** or click outside of this window to save.

Click **New feature** and then click **Add placemark**. You can loosely point to your first stop, or you can randomly select a location for now. Title this place **Stop 1: <stop title>** and make sure you are adding it to your **Lab 13 <your name>** project. Then click **Edit place** and a window will pop up that will allow you input your photograph, a description, and the decimal degrees coordinates your recorded from Google Maps:

1. Click the icon that looks like a camera with a + on it. Drag the photograph for stop one in to the drop box (or click **Select a file from your device**). Your image should now appear in the edit place window. **Note:** you may need to sign in to a Google account in order to have this file upload option (without signing in, you may only see three options: Google Image Search, Video search, and URL). If you do not have, and do not want to create, a Google account, discuss with your instructor an alternate means of submitting these photographs.
2. In the info box (text box underneath Title), type **Coordinates determined from Google Maps using an <your device>** and a short description of why you chose this location. Leave the **Info box** as **Small info box** (the default setting once you have typed anything into the info box).
3. In **Placemark**, click **Show Advanced Options**. Replace **Latitude** and **Longitude** with the coordinates you obtained from Google Maps. Click outside of the window and your placemark should move to your entered coordinates.
4. Leave **Grounding** as **Clamp to Ground**.
5. Under **Set view manually**, click **Reset to defaults**. Click the back arrow at the top left of this window to return to your project.

Your placemark for **Stop 1: <stop title>** will now be listed in your project, and you can go back in to look at or edit anything by selecting it and clicking the pencil icon.

Repeat this with all remaining stops. Your number of placemarks should be equal to the number of stops you made along your route. Double-check this before proceeding.

Step 3: Add a path between your stops to show the route you took.

Zoom out and pan until you can see all of your pushpins.

1. In your project window, click **New feature** then **Draw line or shape**.
2. Single left click at the **tip** of your Stop #1 placemark. This will set the first point of your route path.
3. Then, place points **along the path you walked** until you reach Stop # 2. In other words, add enough points so that you have reasonably described the way you got to the field area. You will

need to use judgement as to how many points you put in around curves. Place a point at the **tip** of your Stop #2 placemark.

4. Continue placing points **along the path you walked** until you reach Stop #3. Place a point at the **tip** of your Stop #3 placemark. Continue doing this until you have reached and placed a point at the **tip** of your final pushpin.
5. Click the final point a second time or press enter. Enter **Route traversed** as the **Place title**, make sure it is being saved in your **Lab 13: <your name>** project folder, then click save. Your path will now be listed in your project.

Step 4: Export your Google Earth output as a KML file.

Click the 3-dot icon in the top right hand corner of your project window, then click **Export as KML file**. This will download your project as a KML file. Navigate to your downloads folder on your computer to find the file.

Submit the KML file according to instructions provided by your instructor.

Reflection Questions

1. Describe one thing you learned about your subject of interest by doing this lab in 2-3 sentences.
2. If you zoom into your map with the path, you will likely notice that your pins do not perfectly align with where you **know** you were standing when you were outside. They are likely off by a few metres or more. Based on the pre-readings, what are some likely explanations for this lack of proper alignment?
3. Knowing what you now know about Google Maps and Google Earth, what would you do differently if you were to do this lab again from the start? If you wouldn't change anything, why did your approach work, and what expert advice would you give to another student working on this lab to help them succeed? Write 2-3 sentences.
4. You have a friend coming to where you live for the first time, but you just came down with cold-like symptoms and need to self-isolate from them. You just finished this lab, so you decided to make them a Google Earth tour of the **must visit** spots where you live. Where would you suggest they go? And how would you produce it? Write a concise 3-5 sentence plan for making the tour.

Worksheets

Print this page out in advance of heading outside, or recreate it by hand on lined or blank paper that you have on hand. Once completed, these are your field notes and must be handed in. You must **not** rewrite these notes. You need to photograph or scan this page as it looked when you returned inside and include it in your submission for EX1.

- Lab 13 Field Notes Template [Word] (<https://pressbooks.bccampus.ca/geoglabmanualv2/wp->

content/uploads/sites/1340/2020/07/Lab-13-Field-Notes-Template.docx)

- Lab 13 Field Notes Template [ODT] (<https://pressbooks.bccampus.ca/geoglabmanualv2/wp-content/uploads/sites/1340/2020/07/Lab-13-Field-Notes-Template.odt>)
- Lab 13 Field Notes Template [PDF] (<https://pressbooks.bccampus.ca/geoglabmanualv2/wp-content/uploads/sites/1340/2020/07/Lab-13-Field-Notes-Template.pdf>)

Back to Lab Exercises

Media Attributions

- New ONLINE Google Earth: Web-Based Google Earth (https://www.youtube.com/watch?v=hz_RfDbHwr8) by Technology for Teachers and Students (<https://www.youtube.com/c/TechnologyforTeachersandStudents>) is licensed under a Standard YouTube License.

Image Descriptions

Figure 13.2. Schematic representation of the correction data provided to GPS receivers by GPS ground stations and servers.

A schematic example of how corrected GPS data is sent to GPS receivers by GPS ground stations and servers. GPS satellites orbiting the earth provide GPS signals to the ground. These are picked up by both handsets with GPS capability (GPS units, cellular phones, etc.), and stationary GPS receivers. The stationary GPS receiver communicates with a GPS server and base stations to correct the GPS data for real time local atmospheric conditions. The base station then communicates with the handheld GPS unit (if it has this capacity) to correct the GPS data that was provided directly from the GPS satellites. This can increase the accuracy of the GPS data from approximately one meter accuracy, to approximately one centimeter accuracy (sometime even more).

[Return to Figure 13.2]

Lab 14: Map Skills I - Defining Location

Ian Saunders; Chani Welch; and Stuart MacKinnon

Maps represent one of the most important tools that geographers use to communicate information about the **spatial associations** of the phenomena which they study. We can think of maps as being **models**, in the sense that they typically aim to reduce the complexity of the real world into something that can be studied more easily. There is a bewildering array of map types; common map types are **base maps**, which show the essential features of the landscape, and **thematic maps**, which show the spatial distributions of probably any geographic variable you care to think of. In Canada, base mapping at the federal government level is referred to as the **National Topographic System (NTS)**.

This lab is largely about how to use NTS maps, plus some Google Earth (Web) practice, to address fundamental questions that geographers ask: How can we specify where a place is? (Geographers know where it's at!) How far is it between two places?

Learning Objectives

After completion of this lab, you will be able to

- Use geographical coordinates and Universal Transverse Mercator (UTM) coordinates to specify locations.
- Convert between different units of geographical coordinates.
- Understand the applications of map scales.
- Derive distances and areas from a map.
- Use Google Earth (Web) to derive coordinates and distances.

Pre-Readings

Geographical Coordinates

The term **geographical coordinate** refers to the **latitude-longitude** system, which defines a location using angles measured from some prescribed baseline. **Latitude** is the angle measured north or south from the equatorial plane to your position. Lines of equal latitude form **parallels** that run west-east. The Equator is at latitude 0° . Latitude ranges from 90°S (South Pole) to 90°N (North Pole). When using latitude data in purely numerical form (i.e. the N or S isn't specified), northern hemisphere data are considered as positive and southern hemisphere data negative. Unless you're using purely numerical data, you **must** specify N or S to avoid ambiguity.

Since parallels must, by definition, be parallel (go figure!) each line of latitude must have a fixed north-south separation between them. On Earth's surface, one degree of latitude represents a distance of approximately 111 km. This is a useful thing to remember, because it enables you to estimate the north-south distance between two places if you know their latitudes. For example, the northern boundary of British Columbia is the 60°N parallel, and most of the southern boundary is at the **49th parallel** (i.e. 49°N); therefore, a very quick estimate of the distance between the two boundaries is:

$$(60 - 49) \times 111\text{km} = 1221 \text{ km.}$$

Longitude is the angle measured west or east from the **Prime Meridian** (or **Greenwich Meridian**, since it runs through the observatory at Greenwich, England) to your position. Lines of equal longitude form **meridians** that run north-south from the North Pole to the South Pole. This means they are not parallel: they are farthest apart at the Equator and converge towards the poles. The Prime Meridian is at longitude 0°. Longitude ranges from 180°W to 180°E. When using longitude data in purely numerical form (i.e. the W or E isn't specified), eastern hemisphere data are usually considered as positive and western hemisphere data negative (but beware – occasionally you may come across the reverse of this convention, for example when using online distance calculators; you need to stay sharp!). Unless you're using purely numerical data, you must specify W or E to avoid ambiguity. Note that the 180°W meridian is also exactly the same as the 180°E meridian, and is also the general location of the International Date Line.

The distance between individual meridians is approximately 111 km at the Equator (i.e. same distance as one degree of latitude) and decreases as you get closer to the poles; this means that estimating west-east distances from longitude data is a little trickier than it is with latitude. The simple solution is that the surface distance between two meridians, one degree of longitude apart, is: $111\text{km} \times \cos(\text{LAT})$, where LAT is your latitude. For example, the west-east distance for one degree of longitude in the central area of British Columbia (55°N assumed) is:

$$111\text{km} \times \cos(55) \approx 64 \text{ km.}$$

Geographical coordinates are based on angles, and there are two common ways to express these:

1. In **decimal degrees (DD)**. Here are three examples: (i) 50.6°N; (ii) 50.57°N; (iii) 50.56789°N. Obviously, the more decimal places we use, the greater the implied accuracy of the coordinate. Using coordinate (i) would be appropriate when defining the location of a town, for example, because this only requires an approximate value. But if we wanted to define the location of a particular building in that town, then greater precision is required, and the extra decimal places in coordinate (iii) would be needed.
2. Using a **sexagesimal** system, which divides one degree into sixty minutes and one minute into sixty seconds. Here are three examples, exactly the same as those in (a), above: (i) 50° 36' N; (ii) 50 34' 12" °N; (iii) 50 34' 04.404" °N. Notice here that if we want to specify very precise locations using the sexagesimal system, we have to add decimal places to the seconds. The units of this system are degrees, minutes and seconds, and hence the units of this system are commonly abbreviated to **DMS**.

Geographical Coordinates on Maps

Different mapping agencies use different ways to denote geographical coordinates on maps, but a common method is to show latitude and longitude markers around the margins. On Canadian 1:50,000 NTS maps (e.g., Figure 14.1), the alternating black and white bar lines along the margins represent minutes of latitude (vertical lines) and longitude (horizontal lines). The latitude increases as one moves northwards (up) away from the Equator and longitude increases as one moves westwards (left) away from the prime meridian. It might also be useful to note that the **neatlines** (i.e. the actual edge of the map) of NTS maps are defined by parallels and meridians (i.e. the top and bottom edges run exactly west-to-east, and the sides run exactly north-to-south).



(<https://pressbooks.bccampus.ca/geoglabs2020/wp-content/uploads/sites/1032/2020/07/figure-12.1-scaled.jpg>)

Figure 14.1. Part of NTS 1:50,000 map sheet 82E14 (Kelowna) 4th edition. Notice that in this example, the map's neatlines are tilted slightly, and are not parallel to the blue UTM grid. This area lies within UTM quadrilateral 11U. Source: Natural Resources Canada (https://ftp.maps.canada.ca/pub/nrcan_rncan/raster/topographic/50k/082/e/14/), Open Government License-Canada (<https://open.canada.ca/en/open-government-licence-canada>). [Click to view

image full size]

There are several items to note in Figure 14.1:

- The marginal information related to geographical coordinates is in black and white:
 - black and white bars up the side: there are seven of them, each representing one minute of latitude, and therefore the north-south extent of the map shown here is nearly 7 minutes of latitude. Every fifth minute has a label: notice the 55' marker in the lower-left edge of the map.
 - black and white bars along the top margin each represent one minute of longitude, and therefore the west-east extent of the map shown here is about 8½ minutes of longitude.
- The northwest corner of the map has coordinates of 50°00' and 119°30', but we are not told which hemispheres. The map-makers assume that we know that Canada is in the northern and western hemispheres.
- Values of latitude increase bottom-to-top, because we are moving farther away from the Equatorial plane. Values of longitude increase right-to-left, because we are moving farther away from the Prime Meridian.

For instructions on how to determine the geographical coordinates of a location when using a NTS map, refer to the Supporting Material.

UTM Coordinates and Grid References

The **Universal Transverse Mercator (UTM)** coordinate system is a type of **Cartesian system**, which means that a location is specified using a rectangular grid. You will be familiar with simple graphing using an x-axis and a y-axis, in which a point can be located by its x value and y value, as follows: (x,y). The UTM coordinate system is similar, but bigger, since it covers most of the Earth! UTM doesn't extend to the polar regions; there a separate system, the Universal Polar Stereographic (UPS) system, applies. Common mapping software (e.g., Google Earth) and GPS receivers often use full UTM coordinates, so it's important to understand how they work.

The UTM system divides the Earth into sixty identical north-south strips or **UTM zones**, each 6 degrees of longitude wide and identified by a number (Figure 14.2). Each zone has a **central meridian** down the middle. Zone 1 is 180°W-174°W, Zone 2 is 174°W-168°W, and so on. So, for example, we find that British Columbia falls into zones 7 to 11. Each zone has latitudinal divisions 8° latitude in extent, that have letter designations (with I and O being excluded) starting with C at 80-72°S. The Equator is the boundary between M and N (useful to remember because the letter indicates which hemisphere you're in: C to M are southern and N to X are northern).

So, with a simple number-letter combination we can easily specify any of the squares (or **UTM quadrilaterals** as they're more formally known) shown on Figure 14.2. This is useful information, of course, because it immediately gives us a good idea of where we are.

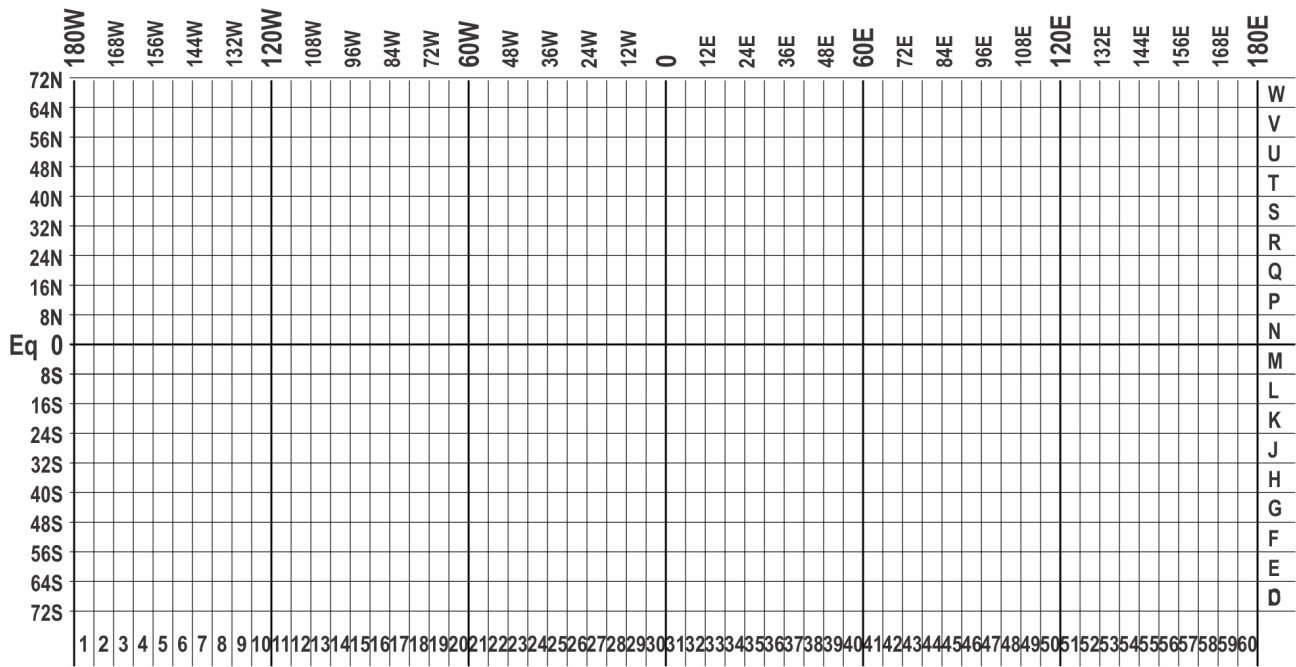


Figure 14.2. UTM quadrilaterals for Earth between 72°S and 72°N. Note: there are local minor deviations from this set pattern but nothing that we need to be concerned with in this lab. Source: I. Saunders, CC BY-NC-SA 4.0.

In each of the northern and southern hemispheres, the UTM zone is treated as a very large (x,y) grid. All zones have a **false origin** (0,0) from which the x value (the **eastings**) and the y value (the **northings**) are derived (Figure 14.3). This is placed 500,000 m west of the zone's central meridian, forcing all eastings to be positive (UTM has no negative numbers). In the northern hemisphere, the false origin is at the Equator; in the southern hemisphere it is set at 10,000,000 m south of the Equator (this ensures that all northings are positive numbers).

UTM coordinates give your position in the number of metres east and north of the false origin, so the numbers end up being large! For eastings, six digits are required, but for northings, seven. A full UTM coordinate contains: (zone number + letter), easting, northing.

Here's a simple example of how UTM works: take a look at Figure 14.3, which shows part of UTM zone 10. We will make a rough estimate of the UTM coordinate of location **x**. It is in UTM quadrilateral 10P. We can see that it is slightly to the east of the central meridian and therefore we know that the easting must be greater than 500,000m; let's say that **x** is 600,000 m east of the false origin. We can also see that **x** is at about 10°N, which means that we can make an educated estimate of how far north it is from the Equator: recall from above that each degree of latitude represents about 111 km of surface distance. Here, we have ten times 111 km, which is 1110 km, or 1,110,000 m. So, a rough estimate of the UTM coordinate of **x** is: 10P 600000mE 1110000mN. More usually the coordinate would be written as 10P6000001110000. Note that the principles outlined here apply to any zone.

Here's a more realistic example: your friend discovered gold and took a GPS measurement, which was: 11U4347825644518.

Let's break this down:

111U: we are in UTM zone 11, which is between 120°W and 114°W. The letter U indicates that we must be between 48°N and 56°N (Figure 14.2).

2434782: the first six digits represent the easting in metres. Note that the number is a bit less than

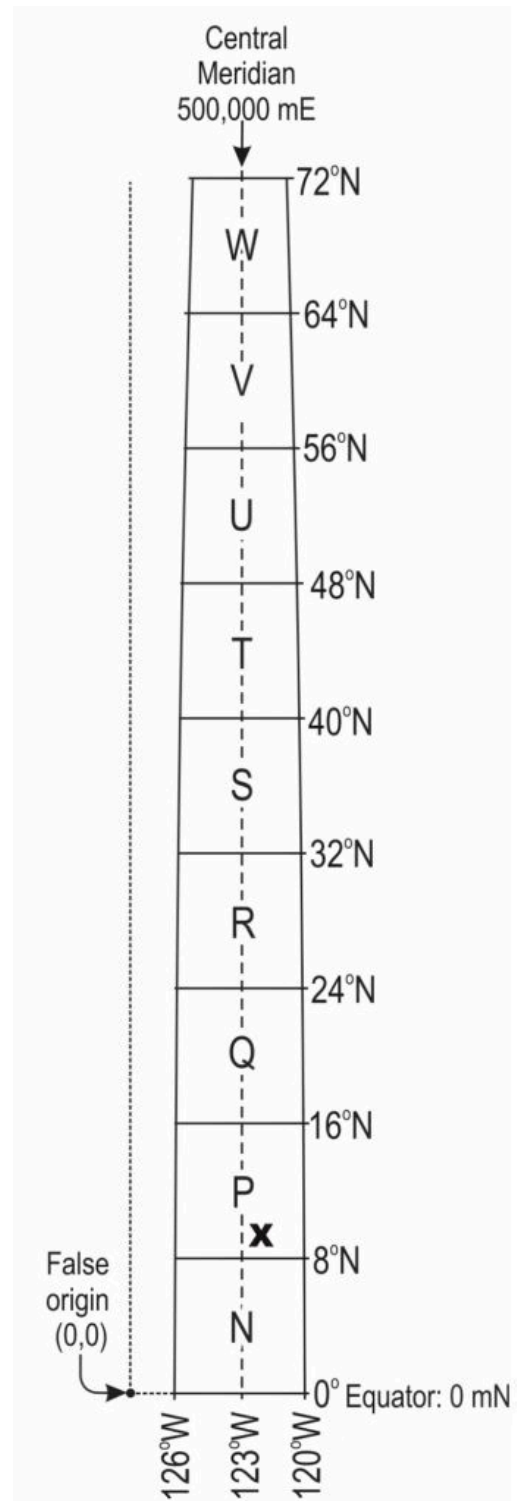


Figure 14.3. Part of UTM zone 10. The false origin is depicted 500,000 m to the west of the zone's central meridian. The UTM coordinate of location **x** is 10P 600000 1110000. Source: I. Saunders, CC BY-NC-SA 4.0.

500,000 m, so this tells us that we must be slightly west from the zone's central meridian (see Figure 14.3).

35644518: the last seven digits represent the northing in metres. So, we are 5,644.518 km north of the Equator, which puts us in Canada.

Although the UTM system may seem a little cumbersome at first, we have uniquely identified a point on the Earth's surface with one coordinate. No other place on the planet has this coordinate. (By the way, the bit about gold was made up, as was the coordinate! Sorry to get your hopes up.)

UTM Grid on NTS Maps

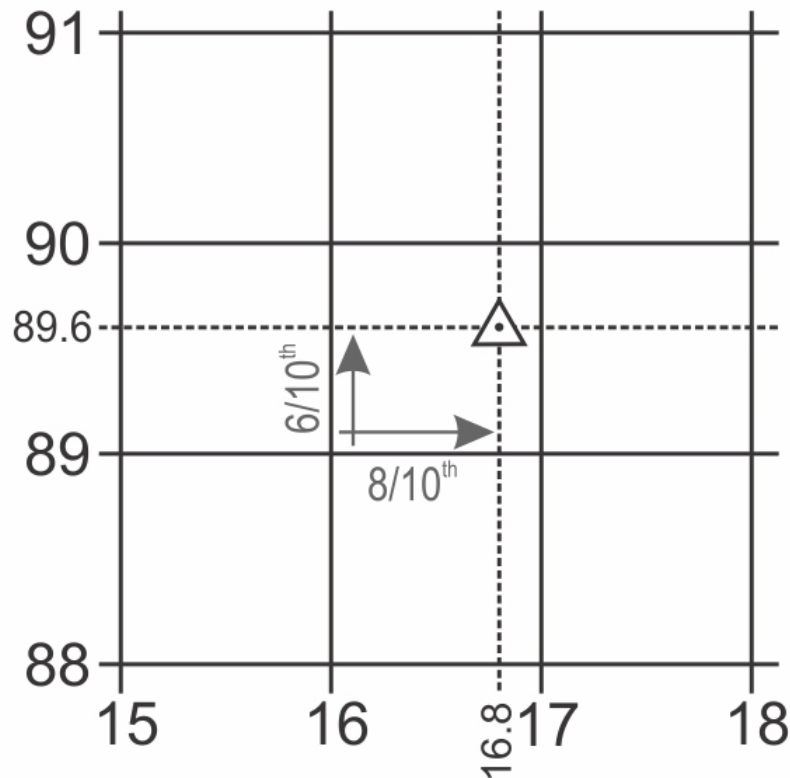
If you examine Canadian 1:50,000 NTS maps, you will see that they are crisscrossed by light blue grid lines (see Figure 14.1). This is the UTM grid, and any light blue text around the map's margins relates to UTM data. On these maps, the grid lines always form squares 20 mm x 20 mm in size, equivalent to 1 km x 1 km in the real-world. The blue grid will line up exactly with the map's margins when the location is at a UTM zone's central meridian, but will tilt slightly as we move away from it. The full easting and northings are shown only at the map's corners; for all other places on the map, you have to derive them yourself.

For instructions on how to determine the UTM coordinate of a location when using a NTS map or Google Earth, refer to the Supporting Material.

6-Figure Grid References

The full UTM coordinate is often unnecessary, especially if you are working in only a limited area, or using just one or a few contiguous map sheets. This is where the **grid reference**—a 6-figure abbreviation of the full UTM coordinate—comes in handy. The aim of the grid reference is to provide a 3-figure easting and a 3-figure northing. The precision of each is to the nearest 100 m. NTS maps usually provide instructions on how to derive a grid reference, but here's the gist of it:

Step 1: Easting. Work left-to-right. In the example shown in Figure 14.4, the easting is between 16 and 17 – in fact, about eight-tenths the way across the grid square. Think of this easting as being **16.8** – and then drop the decimal point to yield 168.



(<https://pressbooks.bccampus.ca/geoglabs2020/wp-content/uploads/sites/1032/2020/07/Estimating-UTM-coordinates.jpg>)

Figure 14.4. Example for determining a 6-figure grid reference. The location of interest is the point inside the triangle. The 6-figure grid reference of this location is 168896. Source: I. Saunders, CC BY-NC-SA 4.0.

Step 2: Northing. Work bottom-to-top. In the example shown above, the northing is between 89 and 90 – about six-tenths the way up. So, the northing is **89.6** which gets abbreviated to 896.

Step 3: Put it together. The grid reference **168896** (not 896168).

Finally, note that we can derive 6-figure grid references from a full UTM coordinate. Let's use the **gold** example one from above: 11U4347825644518. The **11U** part is not used in grid references, but we do need the remaining numerical information:

1. Easting: the full easting is 434782. Since grid references give estimates to the nearest hundred metres, we want to round off the full easting to the nearest decametre (1 dam = 100 m); in this case, it is 4347.82 dam, which rounds off to 4348 dam. We only want the last three digits, so we end up with a 3-figure easting of **348**. If this was on a NTS map, this would be between the blue grid lines of 34 and 35, and much closer to the 35 line.
2. Northing: the full northing is 5644518. Following the principles as for the easting, we can think of this as being a value of 56445.18 dam, which rounds off to 56445 dam. We only want the last three digits, so we end up with a 3-figure northing of **445**. If this was on a NTS map, this would be halfway between the blue grid lines of 44 and 45.

So, we end up with a grid reference of 348445 (but not 445348).

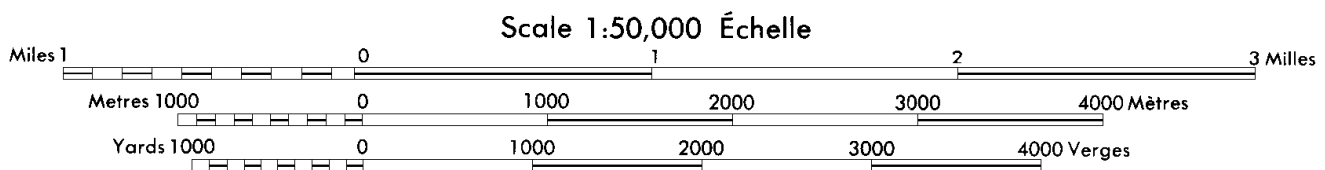
For an example of determining the 6-figure grid reference of a location when using a NTS map, refer to the Supporting Material.

Map Scales

The world is big. Maps are small. So, real-world sizes have to be reduced in order to fit the landscape onto a map, and the **map scale** tells us how much size reduction has taken place.

Map scale can be expressed in several different ways:

- **Graphic scale:** a simple line or bar on the map that states the real-world distance (Figure 14.5). It is simple and intuitive to use.
- **Ratio scale:** one unit of linear distance (e.g., millimetre, inch) on the map represents some number of the **same** units in the real-world. In the previous section, reference was made to 1:50,000 maps – this simply means that 1 mm on the map represents 50,000 mm in the real-world, or 1 inch represents 50,000 inches, and so on. The standard convention is to use the form **1:n**, where **n** can be any number.



(<https://pressbooks.bccampus.ca/geoglabs2020/wp-content/uploads/sites/1032/2020/07/>

Figure-12.4.jpg)

Figure 14.5. Examples of ratio and graphic scales. Source: Natural Resources Canada (http://ftp.geogratis.gc.ca/pub/nrcan_rncan/raster/topographic/50k/082/n/05/), Open Government License-Canada (<https://open.canada.ca/en/open-government-licence-canada>).

- **Verbal scale:** typically, a statement that relays the same information as a ratio-type scale. For example: **1 cm represents 1 km** is self-explanatory – it means that a distance of 1 cm on the map is equivalent to one kilometre in the real-world (so the ratio scale would be 1:100,000). Slightly more esoteric examples are: **5 cm to 1 km**, or **1 cm equals 20 km**, neither of which makes complete grammatical or logical sense, but the meaning should be fathomable for any geographer (the ratio scales are 1:20,000 and 1:2,000,000, respectively).

Being able to convert between different types of scale is a useful skill.

We sometimes hear the terms **small-scale map**, **medium-scale map** or **large-scale map**, and it can be confusing. Perhaps the simplest way to think about this is to realize that a large-scale map will show a given feature larger on the map than a small-scale map would. Think about fitting a map of Canada on this page – you have to shrink the country very small in order to do so, and British Columbia would occupy only a small part of the page. This is a small-scale map. Now envisage a map only of British Columbia on this page – obviously, we can make it larger, and so the scale has become larger, although it would still not be considered a large-scale map. An example of a large-scale map is a 1:50,000 map

sheet, where the map shows the landscape in fine detail. You may also think of this mathematically: convert the ratio to a fraction, and the smaller the fraction, the smaller the map-scale.

Test your understanding: Which map has the largest scale?

- a. Map A, 1:40,000
 - b. Map B, 1:4,000,000
-

Again (because it's important!), map scale always boils down to this basic ratio:

(the length of a feature on the map) : (the real-world length of the same feature)

...and the units must be identical either side.

As an example, on your map the straight-line distance between your house and the shopping mall is 120 mm. In the real-world, this distance is 2.4 km. So, your map's scale is $120 \text{ mm} : 2.4 \text{ km} = 120 \text{ mm} : 2,400,000 \text{ mm} = 1:20,000$.

Deriving Distances from a Map

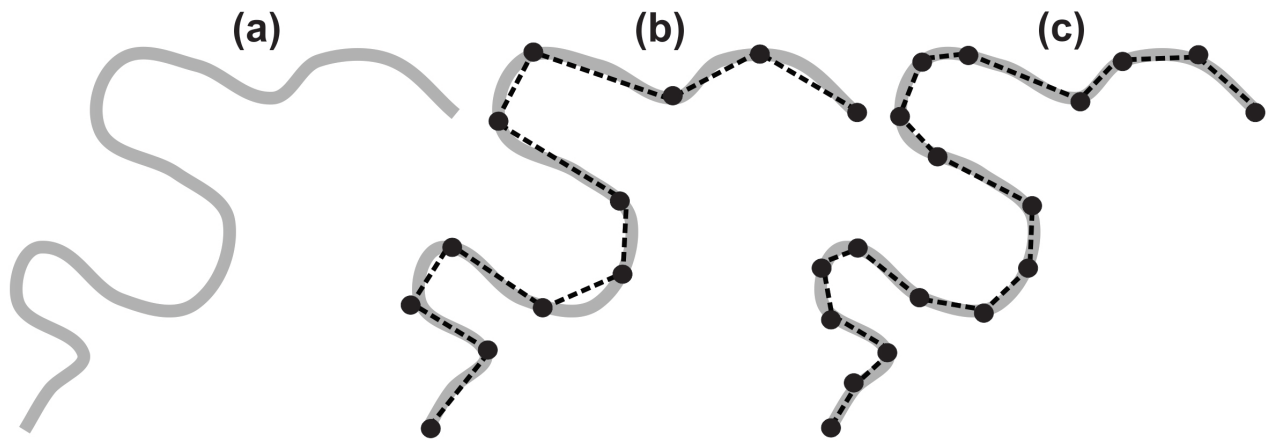
Conceptually, this is simple: measure the distance on the map and multiply it by the scale. For example, 45 mm on a 1:50,000 map represents:

$$45 \times 50,000 \text{ mm} = 2,250,000 \text{ mm}$$

in the real-world. Knowing that $1 \text{ m} = 1000 \text{ mm}$, we can convert this distance to 2250 m.

Measuring straight-line distances is easily achieved with a ruler, of course. Alternatively, you could use the edge of a piece of paper and find the map distance and then compare it to the graphic scale bar.

Measuring distances along curvilinear features such as roads and rivers is more complicated. It is possible to use a ruler and then treat the curved lines (Figure 14.6a) as a series of straight segments (Figure 14.6b). Although this method will tend to underestimate the distance, it will certainly give a rough estimate that's usable. Accuracy can be improved by using shorter straight segments (Figure 14.6c), but this comes at a cost of extra time and effort required.



(<https://pressbooks.bccampus.ca/geoglabs2020/wp-content/uploads/sites/1032/2020/07/Figure-12.5.jpg>)

Figure 14.6. Curved lines as straight-line segments. a. The curved line. b. A series of straight line segments that approximate the distance. c. Shorter, additional straight-line segments to more accurately measure the distance. Source: I. Saunders, CC BY-NC-SA 4.0.

If you are using a hard-copy map, an alternative method of measuring curved lines is to use an **opisometer** (also called a **map measurer**).

For instructions on how to derive distances in Google Earth (Web), refer to the Supporting Material.

Finally, there are also trigonometric methods to derive straight-line distances that use geographical or UTM coordinates but these are beyond the purview of this lab.

Deriving Areas from a Map

When calculating the area of objects on a map keep in mind that scales are linear and cannot be applied directly to area calculations. Therefore, although an area 10 cm wide and 20 cm long on a map is 200 cm² (10 cm × 20 cm = 200 cm²), you cannot take the 200 cm² and use the map scale to get the area in the real-world. Instead, you must multiply each length by the map scale to get real-world lengths (or lengths on the ground) before multiplying together to get the area.

For example, assume you have a map at a scale of 1:10,000, and you want to work out the area in the real-world for a map area that is 10 cm wide and 20 cm long. Follow these steps:

Step 1: Calculate real-world width: Real-world width = map width × map scale = 10 cm × 10,000 = 100,000 cm = 1 km

Step 2: Calculate real-world length: Real-world length = map length × map scale = 20 cm × 10,000 = 200,000 cm = 2 km

Step 3: Calculate the real-world area: Real-world area = Real-world width × Real-world length = 2 km²

Applying the map scale to the map area directly would give an area of $2,000,000 \text{ cm}^2 = 2,000 \text{ m}^2 = 0.002 \text{ km}^2$ which is far too small.

Remember: scales are linear and cannot be applied directly to area calculations.

Useful Unit Conversions for Mapping

Area Conversions

Sometimes it is necessary to convert areas expressed in square kilometres (km^2) to other units such as hectares (ha). The easiest way to do this is to convert to square metres (m^2).

First up, let us convert 1 km^2 to m^2 (Figure 14.7a). In other words, we have a square that has a length and width of 1 km.

Step 1: Convert the length and width of each side of the square from km to m. We know that there are 1,000 m in each 1 km, therefore: Length (= width) = $1 \text{ km} \times 1,000 = 1,000 \text{ m}$

Step 2: Calculate the area of the square in m^2 : Area (m^2) = Length(m) \times width(m) = $1,000 \text{ m} \times 1,000 \text{ m} = 1,000,000\text{m}^2$

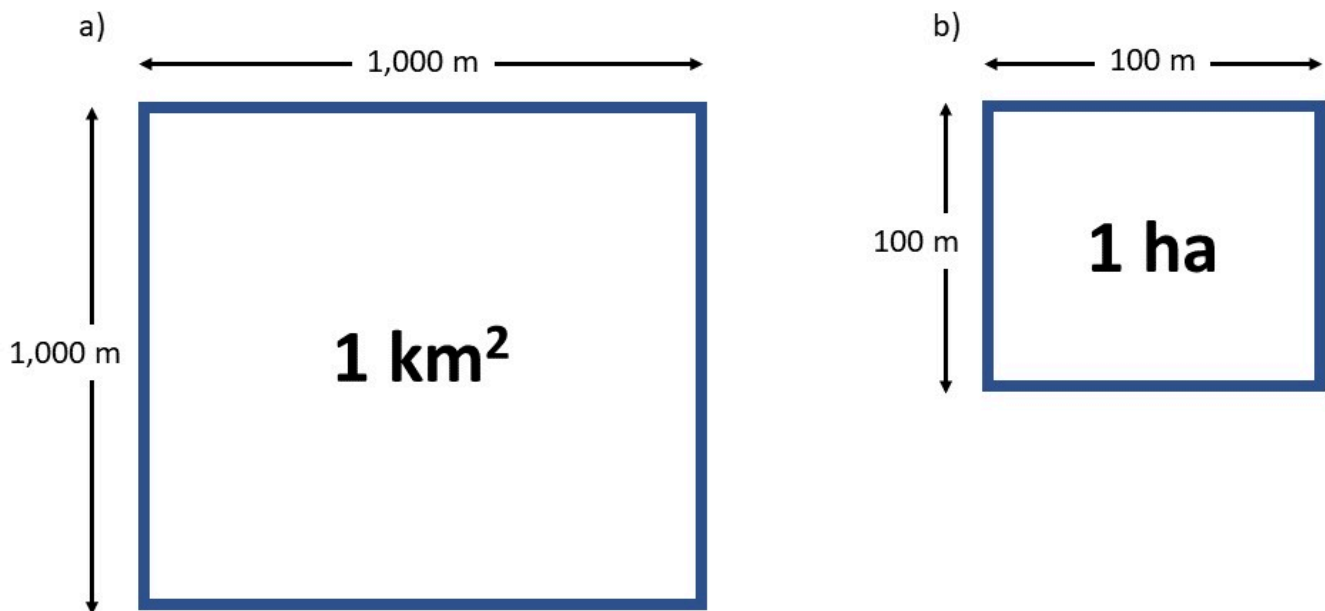


Figure 14.7. Depictions of areas to support conversion between units: a. square kilometres to square metres; b. hectares to square metres. Source: C. Welch, CC BY-NC-SA 4.0.

We can convert 1 ha to m^2 using the same process (Figure 14.7b). In this case, we have a square that has a length and width of 100 m, and so we can skip Step 1, where we converted the length/width to m. This simplifies to:

Calculate the area of the square in m^2 : Area (m^2) = Length (m) \times width (m) = $100 \text{ m} \times 100 \text{ m} = 10,000\text{m}^2$

In summary,

- $1 \text{ km}^2 = 1,000,000 \text{ m}^2$,
- $1 \text{ ha} = 10,000 \text{ m}^2$,
- and hence, $1 \text{ km}^2 = \frac{1,000,000}{10,000} = 100 \text{ ha}$.

Degree Conversions

Coordinates stated in **degrees, minutes and seconds (DMS)** can be converted to **decimal degrees (DD)**, and vice versa, using ratios of

- 60 seconds in a minute,
- 60 minutes in a degree, and
- 3600 seconds in a degree.

For example, coordinates for a location are given in DMS as **49°11'15"**. Convert to DD as follows:

$$= 49 + \frac{11}{60} + \frac{15}{3600}$$

$$= 49.1875^\circ$$

Converting from DD to DMS requires four steps. Coordinates for a location are given in DD as **49.8675°**. Use these four steps to convert to DMS:

Step 1: Obtain the degrees from the number in front of the decimal point = **49°**

Step 2: To obtain the minutes, multiply the decimal by 60 minutes.

$$= 0.8675 \times 60$$

$$= 52.05'$$

The number of minutes is the number in front of the decimal point (**52**).

Step 3: To obtain the seconds, multiply the decimal from Step 2 by 60 seconds.

$$= 0.05 \times 60$$

$$= 03''$$

Step 4: Put together the degrees, minutes and seconds obtained from steps 1-3. The coordinates in DMS are **49°52'03"**.

Lab Exercises

This lab consists of four exercises in which you will practice

- Deriving geographical coordinates, converting between units and using them to find locations on maps and in Google Earth (Web).
- Deriving UTM coordinates and using them to find locations on maps.
- Working with map scales.
- Calculating distances from maps.

You will need a calculator, plus an internet connection to download a map and access Google Earth (Web). Some of the exercises may be easier if you are able to print Figure 14.1. The exercises should take you 1½ to 3 hours to complete.

EX1: Geographical Coordinates

- Using only Figure 14.1, address the following questions:
 - Derive the latitude and longitude of the 669-metre summit about a kilometre NW of McKinley Reservoir. Express your final answer to the nearest 10" (i.e. round off to 00", 10", 20", etc.).
 - What feature is at 49° 55' 40" N, 119° 23' 30" W?
- Open Google Earth (Web) (<https://earth.google.com/web/>) and describe what feature is present at 43° 38' 33" N, 79° 23' 13" W.
- You are exploring BC's beautiful landscapes and are wondering if this is a safe place to pitch your tent. Your GPS receiver indicates that you are here: 54.1895° N, 131.6471° W.
 - Convert the coordinates to DMS. Show your work.
 - Type these coordinates into Google Earth. Where are you?
 - Do you want to camp here? Why or why not?
- Download the 1:50,000 NTS map sheet 01N10 (St. John's) 8th edition [PDF] (https://pressbooks.bccampus.ca/geoglabmanualv2/wp-content/uploads/sites/1340/2021/03/001n10_0800_canmatrix_prt.pdf). Use only this map for the following questions:
 - Derive the latitude and longitude of the steel mill by Octagon Pond, Paradise (lower-left part of map). Express your final answer to the nearest 10".
 - What feature is at 47° 34' 13" N, 52° 40' 55" W? PS: Do you happen to know why this place is famous?
 - Convert these coordinates to decimal degrees (DD) correct to 4 decimal places.

EX2: UTM Coordinates

5. Using only Figure 14.1, address the following questions:
 - a. Derive the full UTM coordinate of the 669-metre summit a kilometre NW of McKinley Reservoir. Express your final answer to the nearest 50 m (i.e. round off to ...00m or ...50m; this is equivalent to the nearest whole millimetre of measurement on the original map).
 - b. Convert your answer for (a) to a 6-figure grid reference.
 - c. What do you find at 11 U 328600 5533850?
 - d. If you worked at the feature at 207306, what are you most likely doing?

6. Use the 1:50,000 NTS map sheet 01N10 (St. John's) 8th edition [PDF] (https://pressbooks.bccampus.ca/geoglabmanualv2/wp-content/uploads/sites/1340/2021/03/001n10_0800_canmatrix_prt.pdf)(same map you used in Q4).
 - a. Derive the full UTM coordinate of the South Head navigation light at the entrance to St. John's Harbour (see the map's legend for the symbol for a navigation light; you will also have to search the map for the UTM zone information). Express your final answer to the nearest 50 m.
 - b. Convert your answer for (a) to a 6-figure grid reference.
 - c. What feature has a UTM coordinate of 22 T 354100 5278750?

7. Using either Figure 14.1 or the 1:50,000 NTS map sheet 01N10 (St. John's) 8th edition [PDF] (https://pressbooks.bccampus.ca/geoglabmanualv2/wp-content/uploads/sites/1340/2021/03/001n10_0800_canmatrix_prt.pdf), identify a location where you would like to eat lunch.
 - a. Derive the full UTM coordinate for the location.
 - b. Explain why it is a good place to eat lunch and how you know this. **Hint:** consider the colour, map legend, what you may be able to view from the location...

EX3: Map Scales

8. Address all of the following to get some practice using map scales:
 - a. On a 1:50,000 map, what does a length of 50 mm represent?
 - b. On a 1:250,000 map, what does a length of 50 mm represent?
 - c. The straight-line distance from point A to Point B is 14 km. What length would this be on a 1:20,000 map?
 - d. Convert the verbal scale **One centimetre equals four kilometres** to a ratio scale.

9. Assume that you need to use a part of a standard 1:50,000 NTS map in your next term paper, but you had to shrink the map in order to fit it on the page. On your new map, the length of ten grid squares is 137 mm.
 - a. Is your map a smaller scale or larger scale than 1:50,000? Explain.
 - b. Calculate the scale of your map.

EX4: Distance

10. Use Figure 14.1 to determine the following distances:
 - a. How long is the runway at Kelowna airport (in metres)?
 - b. What is the straight-line distance (in metres) between the 636-metre summit of Mount Dilworth and the 595-metre summit at 262346?
 - c. What is the shortest distance (in kilometres) by road between the two junctions at 254343 and 286323?
11. Open Google Earth (Web). (<https://earth.google.com/web/>)
 - a. Use Google Earth (Web) to check your answers to Question 10. Refer to Google Earth procedures in Supporting Material.
 - b. Explain why your answers calculated in Q10 and measure in Q11a are not identical.
12. In previous exercises we assumed that the cutting, pasting and uploading and/or printing of the map section on Figure 14.1 did not change the map scale. It is now time to check this, so that you can calculate the area of **Knox Mountain Park** accurately. If you have not printed Figure 14.1, you can measure the distances on your screen, just remember that you must not change the magnification of your screen between measurements in this exercise.
 - a. Unfortunately, this map section does not contain the graphic scale. However, you know that the blue UTM grid represents squares that are 1000 m wide and 1000 m tall. Using your ruler, measure the width of one grid square (in mm) and use this distance to calculate the scale of the map as printed/appears on your screen. Express it as a ratio. Show your work.
 - b. Use the map scale calculated in (a) to calculate the area of Knox Mountain Park in m^2 , km^2 and ha. Show your work.

Reflection Questions

1. One of the most fundamental issues in geography is location – Where am I? Where is this place? Where is that place in relation to the other place? Think about the different ways in which location can be defined and specified. Explain how you would tell someone exactly where you are right now, the square metre of Earth’s surface that you are currently occupying! How would your description be different if you simply wanted to give the general location of the town that you are in?
2. You have arranged a hiking trip for yourself and some inexperienced friends. You have printed out some UTM topographic maps and brought along a couple of GPS units (you knew your friends wouldn’t). Unfortunately, none of them know how to read a map or use GPS! How would you describe to your friends how to locate themselves on the map using the UTM coordinates obtained from the GPS unit?
3. Google Maps has crashed, but Google Earth (Web) is fine (somehow) and you need to figure out how to get from Kelowna, BC to Fort St John, BC. You know that you can look up both Kelowna and Fort St John and pin them in Google Earth, and that enabling the **Roads** layer will give you all major roads in BC. How could you figure out the distances of different path options and choose the quickest route?

Supporting Material

Instructions for Using and Accessing Maps

Contents

How to Derive Geographical Coordinates from a 1:50,000 NTS Map

How to Derive UTM Coordinates from a 1:50,000 NTS Map

How to Derive a 6-Figure Grid Reference from a 1:50,000 NTS Map

How to Measure Distance in Google Earth (Web)

How to Download NTS Topographic Maps

How to Derive Geographical Coordinates From a 1:50,000 NTS Map

First, take another look at Figure 14.1. We are going to get the coordinates of Wilson Landing. Wilson Landing is located in the top-left of the map. A schematic of the location of Wilson Landing is shown on Figure 14.8.

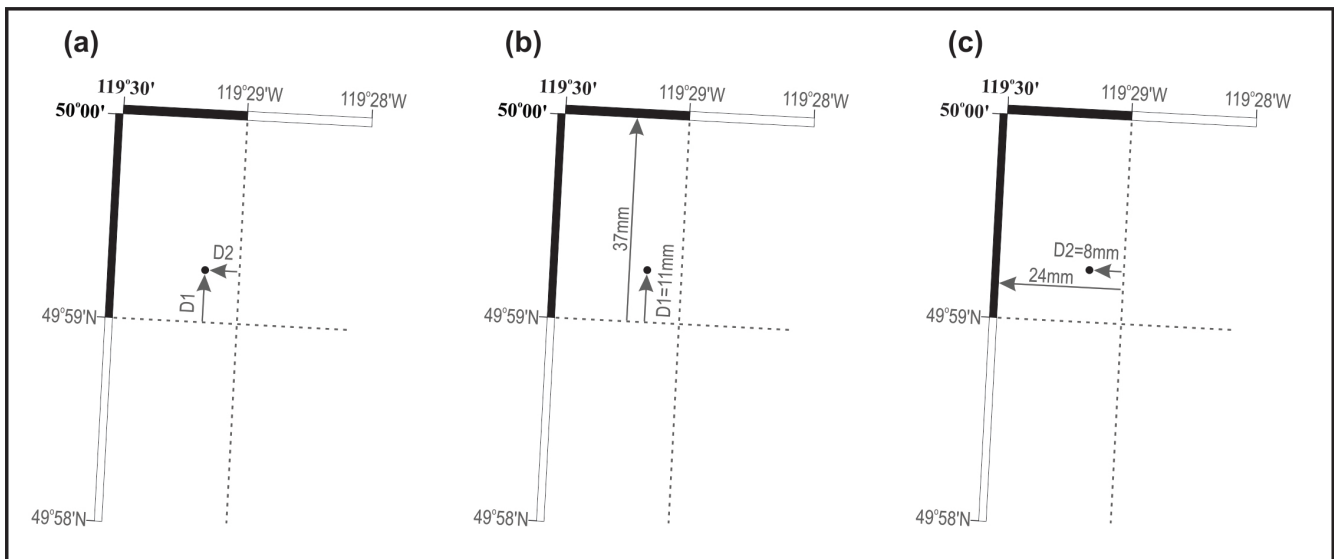


Figure 14.8. Steps to determining geographical coordinates from a 1:50,000 NTS map. Source: I. Saunders, CC BY-NC-SA 4.0.

Step 1: Find the approximate location. Using Figure 14.8a, we can estimate the latitude and longitude: the location is slightly north of $49^{\circ} 59' N$ and slightly west of $119^{\circ} 29' W$. Estimating by eye, the arrows indicate that we will add about one-quarter to one-third of one minute of arc to this estimate. To get an answer better than a simple by-eye estimate, we will make measurements on the map. **Note** that the grey arrows depicting measurements are parallel to the map's neatlines and not the blue grid squares.

Step 2: Derive latitude (Figure 14.8b). We are looking to derive the proportion of one minute of arc that is between the $49^{\circ} 59' N$ parallel and Wilson Landing: distance D1. On the original map used in here, the proportion is 11mm:37mm. Therefore, distance D1 must be $11/37^{\text{th}}$ of one minute of arc:

$$= \frac{11}{37} \times 60 \text{ seconds} = 18 \text{ seconds.}$$

Step 3: Derive longitude (Figure 14.8c). We are looking to derive the proportion of one minute of arc that is between the $119^{\circ} 29' W$ meridian and Wilson Landing: distance D2. On the original map used in here, the proportion is 8mm:24mm. So, distance D2 is $8/24^{\text{th}}$ of one minute of arc

$$= \frac{8}{24} \times 60 \text{ seconds} = 20 \text{ seconds.}$$

Step 4: Compile. The geographical coordinates of Wilson Landing are $49^{\circ} 59' 18'' N$, $119^{\circ} 29' 20'' W$.

[Back to Supporting Material contents](#)

How to Derive UTM Coordinates From a 1:50,000 NTS Map

Again, we'll use Wilson Landing in Figure 14.1 as our working example.

Step 1: Find the UTM quadrilateral. This information isn't shown on Figure 14.1, but it would be found on the original map sheet; in this case, it happens to be **11U** (see Figure 14.9).

Step 2: Derive the Easting. At the top corner of the map sheet we can see the true easting given for one of the blue grid lines: 322000 mE. The grid line to the left is 1000 m away and so must have an easting value of 321000 mE. Wilson Landing lies between the two. To get the best estimate of the easting, we should measure how far it is from the 321000m grid line to our location: in this case, on the original map, it is 13 mm, to the nearest whole millimetre (it's not usually valid to use a finer precision than this). At a scale of 1:50,000, 13 mm represents 650 m in the real-world, and so this distance is added to the 321000m to get our full easting: 321650 mE.

Step 3: Derive the Northing. The top-most horizontal blue grid line has a full northing of 5541000 mN (see the blue number in the upper-left part of Figure 1), and so the next grid line to the south must have a value of 5,540,000 m. Making a measurement on the map, we find that Wilson Landing is about 300 m north of the latter grid line and therefore the full northing is 5540300 mN.

Step 4: Compile. Put it all together to get a UTM coordinate in the format of UTM quadrilateral **Easting** **Northing**: 11U**321650**5540300.

Back to Supporting Material contents

How to Derive a 6-Figure Grid Reference From a 1:50,000 NTS Map

The 6-figure grid reference, again, for Wilson Landing, is derived from the blue UTM grid and numbers in Figure 14.1.

Step 1: Derive the Easting. Work left to right: Wilson Landing is between grid lines 21 and 22 (interpolated from the blue numbers along the top of map). Moving right from the 21 grid line, Wilson Landing is about six-tenths the distance to the 22 grid line, therefore the easting part of the grid reference is 216 (you can think of it as 21.6, but without the decimal point).

Step 2: Derive the Northing. Working bottom to top, we can see that Wilson Landing is between horizontal grid lines 40 and 41, and about three-tenths the distance between them: so, the northing part of the grid reference is 403.

Step 3: Compile. Put the easting and northing together (**Easting** **Northing**) to get a grid reference of **216403**.

Can you see, by inspection, how you can also derive a 6-figure grid reference from the full UTM coordinate?

Back to Supporting Material contents



Figure 14.9. Grid zone designation from NTS 1:50,000 map sheet 82E14 (Kelowna) 4th Edition: 11U. Source: Natural Resources Canada (https://ftp.maps.canada.ca/pub/nrcan_rncan/raster/topographic/50k/082/e/14/), Open Government License-Canada. (<https://open.canada.ca/en/open-government-licence-canada>)

How to Measure Distance in Google Earth (Web)

To derive a straight-line distance: The bottom icon on the left-hand menu is a ruler. Click this. Mouse-click once to start a line, then double-click at a second point to end the line. Change the units using the dropdown menu adjacent to the distance in the box that pops up in the top right of the screen.

To derive a curved-line distance: The bottom icon on the left-hand menu is a ruler. Click this. Mouse-click once to start a line, single-click at a point to put your second point, single-click at a point to put your third point, and so-on. Double-click at your final point to end the line.

Back to Supporting Material contents

How to Download NTS Topographic Maps

Option 1: If you don't know the map sheet's number: access the Geogratis Topographic Information website (<http://www.geogratis.gc.ca>) and select the **Geospatial Product Index – HTML**. You can then zoom in or out of the map and the map codes will appear. For example, zoom in on Vancouver: you will first see **92** appear, then a grid with letter codes, and then number-letter-number codes which are the 1:50,000 map IDs; downtown Vancouver is map sheet **92G06**. You may get access to the maps directly from here, but if not, record the map sheet number and go to Option 2.

Option 2: If you know the map sheet's number: access Geogratis's ftp site for 1:50,000 map sheets. (http://ftp.geogratis.gc.ca/pub/nrcan_rncan/raster/topographic/50k/) You will find *.tif and *.pdf files available; these are scanned versions of the original NTS map sheets.

Back to Supporting Material contents

Lab 15: Map Skills II - Understanding Direction and Topography

Ian Saunders; Chani Welch; and Stuart MacKinnon

This lab addresses the fundamentals of how to specify direction and then focuses on the three-dimensional nature of the landscape as expressed in **topographic maps** – maps which show the three-dimensional landscape by means of **contour lines**. It builds on the material that was covered in Lab 14, such as deriving locations and distances from a map, so be sure that you are familiar with that material before starting this lab.

Nearly every land surface on Earth is composed of **slopes** (even if, at first glance, they appear to be flat). The direction in which a slope faces is known as its **aspect** (in other words, it's the direction down the slope). It is the infinite number of combinations of slopes and aspects that make up the physical landscape.

This lab is about how to use topographic maps to gain an appreciation of the three-dimensional landscape from a two-dimensional map. We will seek answers to such questions as: In which direction are we looking/going? How high is the land here? How steep is that slope? What profile shape is that hillside? How do we interpret topographic profiles?

Learning Objectives

After completion of this lab, you will be able to

- Specify directions using the three principal types of azimuth.
- Understand how to use contours to determine elevation and slope.
- Draw and interpret topographic profiles.
- Draw contour intervals from spot heights.

Pre-Readings

Directions

We are all familiar with the points of the compass (Figure 15.1a), also known as **cardinal directions**. These allow us to specify general directions, but are insufficient to define specific values. For this we use an **azimuth**, which is the angle measured clockwise from north (Figure 15.1b). The term **bearing** is often used synonymously with azimuth, although there are also some other uses of the term, so azimuth

will primarily be used here. Therefore, north has an azimuth of 0° , northeast is 45° , east is 90° , and so on. The range of azimuth values is 0° to 359° .

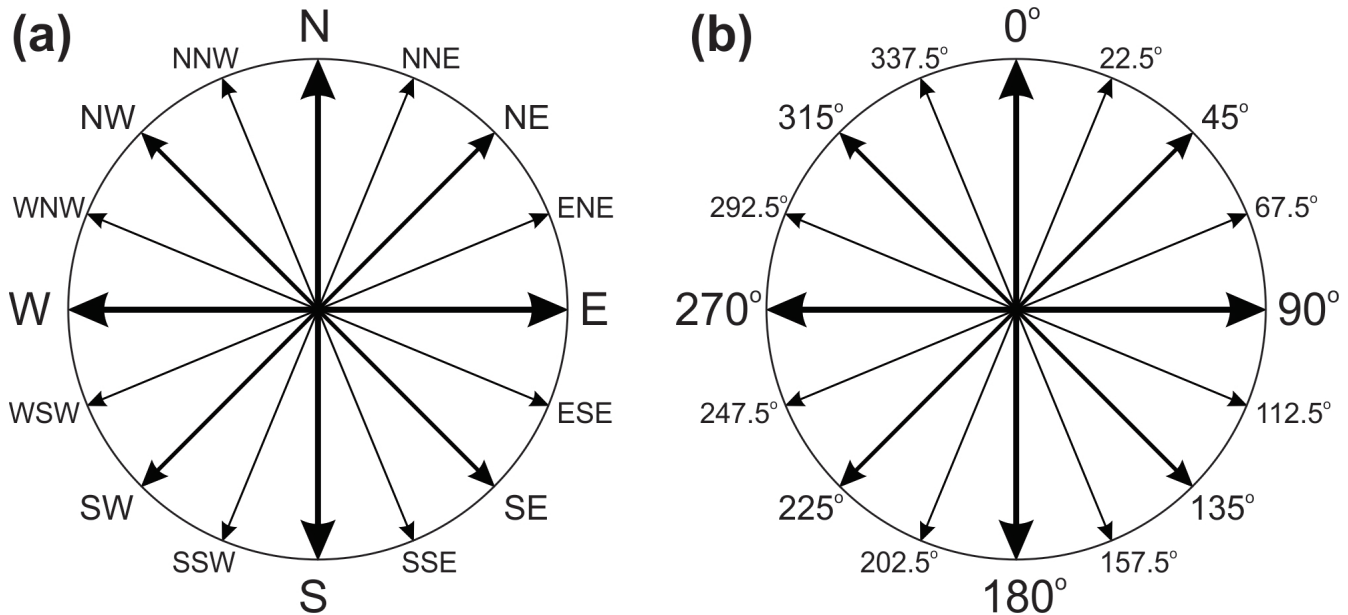


Figure 15.1. a. Compass points. b. Equivalent azimuths. Source: I. Saunders, CC BY-NC-SA 4.0.

Although conceptually simple, defining an azimuth is made a little more problematic because there are three different north arrows to choose from! These are:

1. **True North:** this is the straight-line direction to the Geographic North Pole (GNP). This is also equivalent to following a meridian. An azimuth referenced from True North is called a **True Azimuth**. Since the GNP is a fixed point on Earth, a True Azimuth for any particular location will never vary.
2. **Grid North:** this is the straight-line direction that runs northwards parallel to the Universal Transverse Mercator (UTM) grid on a NTS map. An azimuth referenced from Grid North is a **Grid Azimuth**. At most locations, the UTM grid will vary slightly from the latitude-longitude grid, and therefore there is usually a small difference between True North and Grid North.
3. **Magnetic North:** this is the direction towards the North Magnetic Pole (NMP), and is the same direction that a magnetic compass needle points towards. An azimuth referenced from Magnetic North is a **Magnetic Azimuth**. The Earth's magnetic field is dynamic and always changing its position, and therefore the location of the NMP is always moving. This means that a magnetic azimuth that is correct this year will be slightly incorrect next year. The difference between True North and Magnetic North varies widely.

In reality, the Grid North arrow may be to the west or to the east of the True North arrow and, likewise, the Magnetic North arrow may be to the west or to the east of the True North arrow. All combinations are possible, and are location-dependent.

When converting between different types of azimuth, we need to have information about where the three North arrows are —this is typically provided by a **declination diagram** (although some mapping agencies provide the information verbally). An example is shown on Figure 15.2, using made-up values of True North and Magnetic North:

- The difference between True North and Magnetic North is known as the **magnetic declination**. In the example shown in Figure 15.2, this is 14° W. We must specify **West** or **East** to avoid ambiguity; in this case, it is **West** because the Magnetic North arrow lies to the west of True North.
- The difference between Grid North and Magnetic North is known as the **grid declination**. In Figure 15.2, this is 17° W. Again, we must specify **West** or **East** to avoid ambiguity; in this case, it is **West** because the Magnetic North arrow lies to the west of Grid North. Grid declination is necessary when converting between magnetic compass bearings and grid azimuths, which is a very useful field skill.
- The difference between Grid North and True North is known as the **grid convergence angle**. In Figure 15.2, this is 3° E.

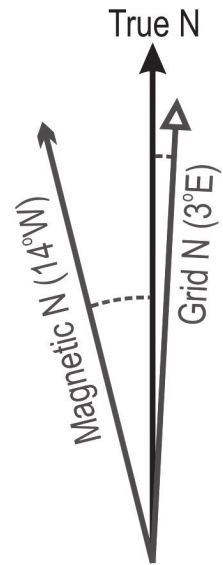


Figure 15.2. A declination diagram. In this case, Magnetic N is 14° west of True N, and Grid N is 3° east of True N. Source: I. Saunders, CC BY-NC-SA 4.0.

How do we apply this knowledge? Let's apply the grid declination diagram of Figure 15.2 to calculate the azimuths for the direction A-B in Figure 15.3. Assume that the direction from A to B is 75° True. Portraying things visually help us see how the different azimuths can be derived.

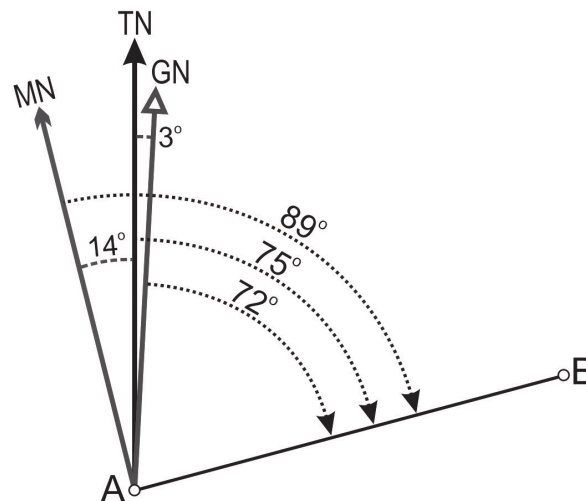


Figure 15.3. Deriving azimuths for the direction A-B. MN is Magnetic North, TN is True North, and GN is Grid North. Source: I. Saunders, CC BY-NC-SA 4.0.

- By inspecting Figure 15.3 we can see that the angle between Grid North and the A-B direction is slightly smaller than that between True North and A-B – in fact, it is 3° smaller and therefore: $\text{Grid Azimuth} = 75^\circ - 3^\circ = 72^\circ$.
- Similarly, we can see that the angle between Magnetic North and the A-B direction is 14° larger than that between True North and A-B, so: $\text{Magnetic Azimuth} = 75^\circ + 14^\circ = 89^\circ$.
- So, the direction from A to B can be specified as any or all of: 75° True, 72° Grid, or 89° Magnetic.

When using azimuths in a real-world situation, we need the actual declination diagrams from the study

area (preferably the latest edition). Figure 15.4 and Figure 15.5 show additional examples from Canadian 1:50,000 NTS maps. These diagrams have been simplified for clarity.

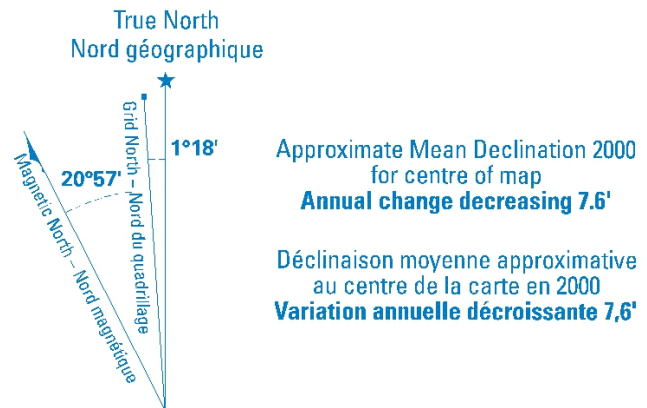


Figure 15.4b. Declination diagram for St. John's, NL. Declination diagram for Victoria, BC. Magnetic declination is 22°15' W. Grid declination is 20°57' W. Grid convergence angle is 1°18' W. The grid declination is decreasing 7.6' annually. Source: Natural Resources Canada (http://ftp.geogratis.gc.ca/pub/nrcan_rncan/raster/topographic/50k/001/n/10/), Open Government License-Canada (<https://open.canada.ca/en/open-government-licence-canada>).

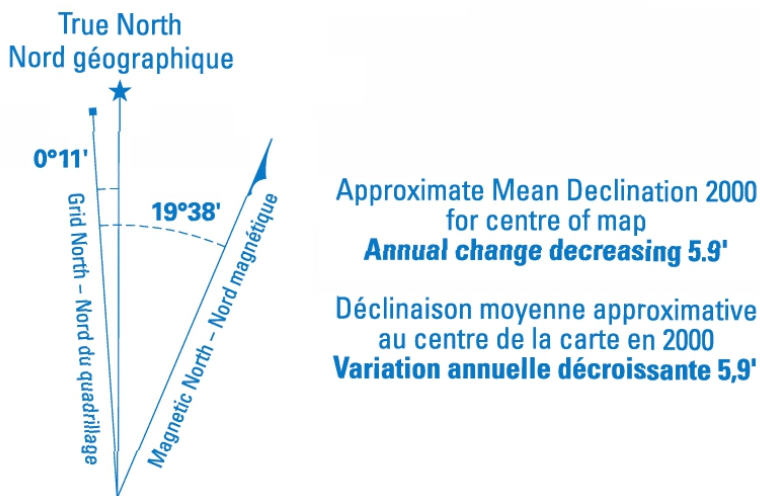


Figure 15.4a. Declination diagram for Victoria, BC. Magnetic declination is 11' W. Grid declination is 19°38' W. Grid convergence angle is 19°27' E. The grid declination is decreasing 5.9' annually. Source: Natural Resources Canada (http://ftp.geogratis.gc.ca/pub/nrcan_rncan/raster/topographic/50k/092/b/06/), Open Government License-Canada (<https://open.canada.ca/en/open-government-licence-canada>).

Notice that the date of the magnetic information is given, and the rate of change in it. This allows us to calculate the grid declination for the current year. For example, we can see that the grid declination in Victoria, BC, was 19° 38' E in 2000 (Figure 15.4a), and it was decreasing by 5.9' annually. So, in 2020 the value is 19° 38' E minus the accumulated changes in the intervening years. The accumulated changes to the grid declination are the number of years multiplied by the annual change in the grid declination: $(2020 - 2000) \times 5.9' = 118'$.

Recall that there are 60 minutes in a degree. Therefore, the 2020 value of the grid declination at Victoria is: (Value in 2020 – Accumulated changes = $19^{\circ} 38' \text{ E} - 118' = 17^{\circ} 40' \text{ E}$.)

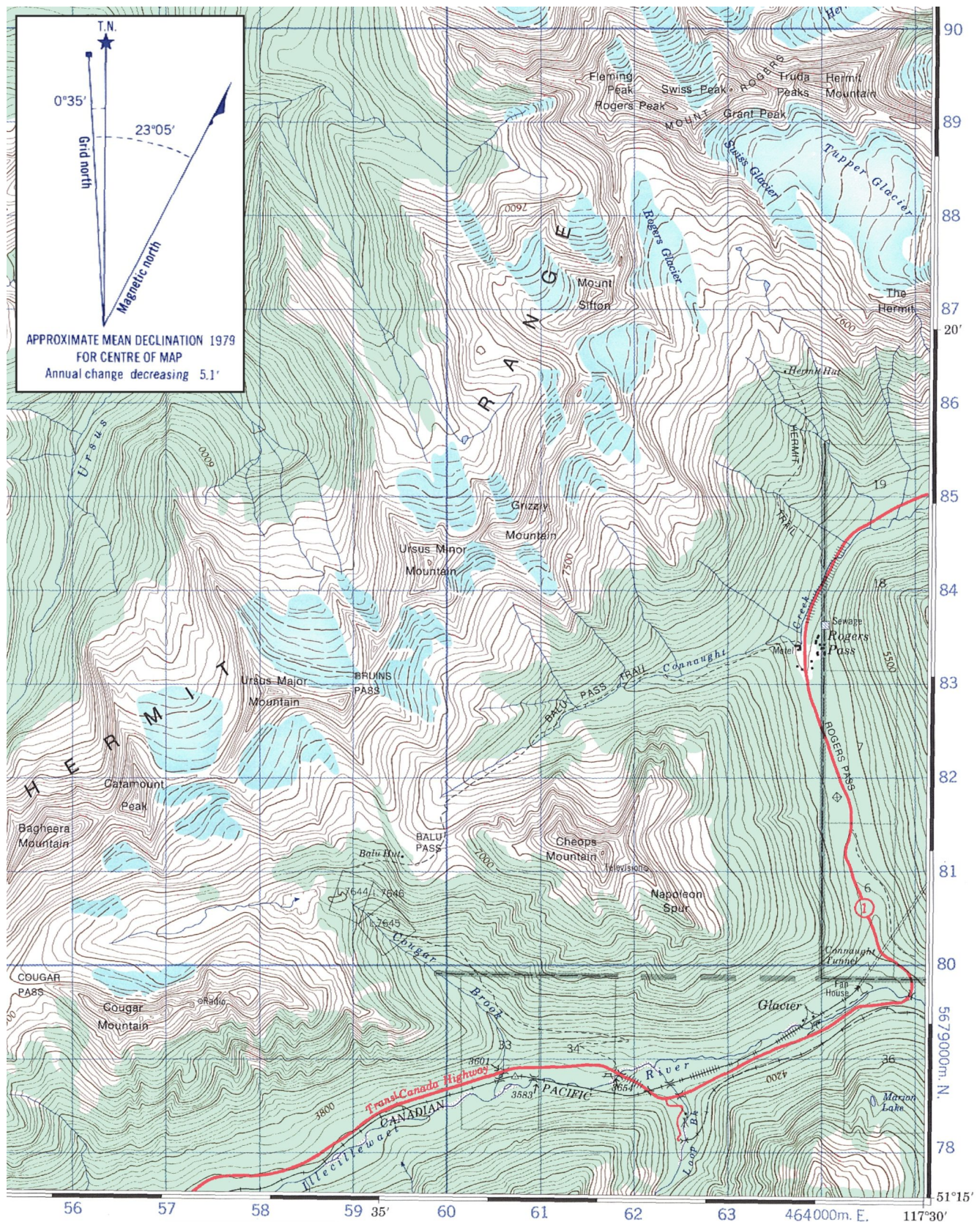


Figure 15.5. Part of NTS 1:50,000 map sheet 82N05 (Glacier) 3rd edition. Elevation units are in feet. Magnetic declination is 22°30' E. Grid declination is 23°05' E. Grid convergence angle is 35' W. The grid declination is decreasing 5.1' annually. Source: Natural Resources Canada (http://ftp.geogratis.gc.ca/pub/nrcan_rncan/raster/)

topographic/50k/082/n/05/), Open Government License-Canada. (<https://open.canada.ca/en/open-government-licence-canada>)

Height Datums and Units

When talking about how high a land surface is, we need a reference level, sometimes referred to as the **height datum** (not to be confused with a geodetic datum, which is an issue that we don't need to discuss here). Hereafter, we will use the term **elevation** to define the height above (or, sometimes, below) a height datum. A standard convention in topographic maps is to define elevation relative to the mean sea level (metres above sea level, m a.s.l.).

In all cases where elevation is involved, be careful to check what units are being used. The units of elevation are typically feet or metres. See the map's legend to find out. Note that older editions of a particular map sheet might use feet, but later editions of the same map sheet might use metres. Always check!

Spot Heights and Benchmarks

One of the simplest ways to indicate the elevation of land on a map is to use a **spot height**, which is simply the elevation of a particular point (e.g. the summit of a hill or mountain). Many spot heights are determined from aerial photographs, rather than being surveyed on the ground. Occasionally, you may also see a **benchmark** shown on a map. These are points that have been surveyed, perhaps as part of construction projects such as highways or rail lines. Locations that have been surveyed for the purposes of map making or town planning (for example) are known as **horizontal control points**. Many horizontal control points will have a small metal marker affixed to the ground. Figure 15.6a provides examples of a spot height (elevation = 1377, indicated by the brown dot in the centre of a closed contour) and a benchmark (elevation = 1256, indicated by a black arrow). Figure 15.6b shows an example of a horizontal control point (elevation = 8622, indicated by a triangle with a dot in the centre).

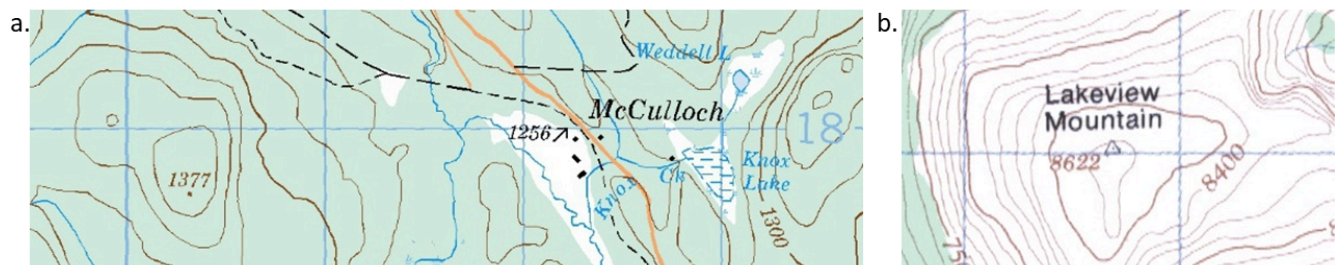


Figure 15.6. a. Example of a spot height (elevation = 1377) and a benchmark (elevation = 1256). b. Example of a horizontal control point (elevation = 8622). Note: Elevation units may be feet or metres – you need to check the map. Sources: a. NTS 1:50,000 map sheet 82E14 (http://ftp.geogratis.gc.ca/pub/nrcan_rncan/raster/topographic/50k/082/e/14/) (Kelowna) 4th edition. b. NTS 1:50,000 map sheet 92H01 (http://ftp.geogratis.gc.ca/pub/nrcan_rncan/raster/topographic/50k/092/h/01/) (Ashnola River) 2nd edition. Natural Resources Canada, Open Government License-Canada (<https://open.canada.ca/en/open-government-licence-canada>).

Contour Lines

Contour lines (or simply **contours**) on a topographic map are the most common way of showing the three-dimensional landscape. With practice, a geographer can easily visualize the landscape from a two-dimensional map sheet—a valuable skill.

Contours are lines that connect points of equal elevation. One way of envisaging this is to imagine a valley filled with water. If you drew a line along the shoreline, it would be a contour line. If you dropped the lake level by, say, ten metres and again drew a line along the shoreline you would have a second contour line. Repeating this exercise again and again would leave you with a landscape covered in horizontal lines all ten vertical metres apart (known as the **contour interval**). You have just made a topographic map! In practice, contours are typically derived by a combination of ground surveys and analyses of aerial photographs.

If we follow the hypothetical procedure for deriving 10-metre contours outlined above, it will be obvious that in very flat areas, a contour interval of ten metres will probably not allow you to pick up the subtleties of the landscape. On the other hand, in a mountainous region a contour interval much greater than ten metres would be advisable, otherwise there would be so many contours that nothing else could be mapped! So, always check the contour interval of the topographic map you're using. It will normally be found in the map's legend. You will also normally find that contour interval increases as map scale decreases.

A map's contours allow us to derive some fundamental pieces of information: how high we are (our **elevation**), the steepness (or **gradient**) of the slope, the slope's profile shape, and the overall **relief** of the landscape. The usual use of the term relief is to qualitatively describe the range of elevations found in a given area (known as **relative relief**). A **high-relief landscape** is one in which there is a great difference between the low and high elevations, such as in mountain ranges. Conversely, a **low-relief landscape** such as a plateau has little elevation range. Don't confuse **relief** with **elevation**. We might have a **high-elevation low-relief landscape** just as easily as a **low-elevation low-relief landscape**.

Types of Contours

There are several different types of contours that are good to know about:

1. **Index contours.** Typically, every fifth contour is a bolder line than the regular contour. This is especially useful in high-relief terrain because it allows us to find elevations from the map without having to count every single contour: we can go up/down the mountainside by jumping from one index contour to the next.
2. **Approximate contours.** These are similar to regular and index contours but are drawn using a short-dashed line. This indicates that the exact elevation of the surface was difficult to determine and/or may vary in time.
3. **Auxiliary contours.** If a map shows low-relief terrain adjacent to high-relief terrain, extra contours with a smaller contour interval are sometimes used in the low-relief area to provide more topographic detail. On NTS maps, these are depicted as long-dashed brown lines.
4. **Depression contours.** (Figure 15.7a) These indicate where the land inside a closed-loop contour is lower (i.e., a depression – or hollow – in the surface). The contour line has small

hachure marks that face downhill, into the depression.

5. **Cliff symbol.** (Figure 15.7b) Okay, so this is not an actual contour line, but it is worth adding to our list. When slopes get very steep and become cliffs, it may be difficult or impossible to use contours, so a symbol is used instead. The tightly-spaced hachure marks indicate the way the cliff faces.

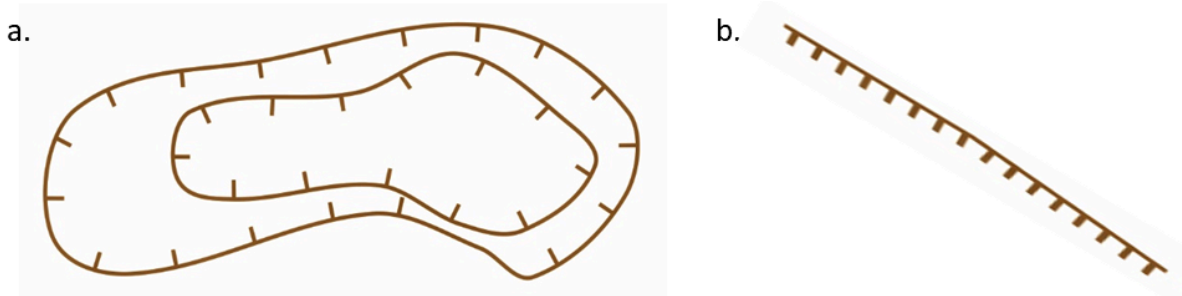


Figure 15.7. a. Depression contours indicate that terrain within the contour is a depression. b. Cliff symbols indicate a cliff face. Source: I. Saunders, CC BY-NC-SA 4.0.

Interpreting Contour Lines

When interpreting contour lines, there are several key points to remember:

1. A contour always separates land that is higher from land that is lower.
2. All contours are single, continuous lines. They do not split or cross over each other.
3. A closed-loop contour always indicates that there's higher ground inside the loop, unless it is a depression contour.
4. On Canadian NTS maps, the convention is that contour labels are oriented to indicate which is uphill. Look carefully at Figure 15.5, for example: along the Illecillewaet River valley at the bottom of the figure, you can see two contour labels on either side of the valley, **3800** and **4200**. Uphill is the direction above the top of the number if you were reading it normally.
5. If you see contours form a **V** pattern along a watercourse, the **V** always points upstream. If you're at a sharp ridge, such as a glacial arete or a large lateral moraine for example, the **V** pattern in the contours points downhill. Figure 15.5 has several good examples: note the contours along Cougar Brook (at the bottom SW of the figure) where the **V** pattern points uphill, toward the creek's headwaters. Just to the east of there, examine the contours at Napoleon Spur – the **V** pattern points down the ridge crest.

Deriving Slope Gradients from Maps

There are several different ways of expressing slope gradient, and all of the most common ones are based on the ratio of horizontal and vertical distances between two points (the classic **rise over run** situation). To find the slope we need two values: the horizontal distance between points A and B, and the elevation difference between them (Figure 15.8). The horizontal distance (Δx) is found by measuring it on the map and using the map's scale to convert to real-world distance (i.e. exactly what

you were doing in Lab 14). The vertical distance between A and B (Δz) is the elevation difference between them, which can be found by interpolating from contours and/or spot heights.

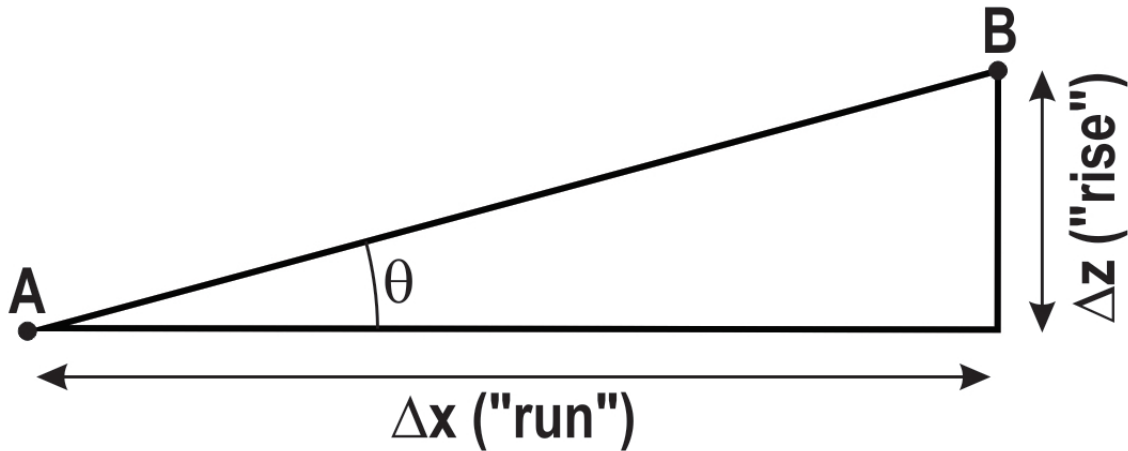


Figure 15.8. Fundamental elements of a slope. Source: I. Saunders, CC BY-NC-SA 4.0. [Image description]

Once we have this information, the slope gradient can be calculated and expressed in three ways:

1. As a percent (%): the fraction (rise \div run) expressed as a percentage (Equation 15.1):

Equation 15.1

$$\text{Gradient}(\%) = \frac{\text{Rise, } \Delta z(m)}{\text{Run, } \Delta x(m)} \times 100\%$$

2. As an angle, θ (degrees) (Equation 15.2):

Equation 15.2

$$\text{Gradient}(\text{°}) = \text{Tan}^{-1} \left(\frac{\text{Rise, } \Delta z(m)}{\text{Run, } \Delta x(m)} \right)$$

3. In elevation change per slope distance (m/km): the gradient expressed with different units used for **rise** and **run**, but with the **run** always reduced to one unit, commonly 1 km (Equation 15.3):

Equation 15.3

$$\text{Gradient}(m/km) = \frac{\text{Rise, } \Delta z(m)}{\text{Run, } \Delta x(km)}$$

For example, let us assume that the elevation difference we interpolated between points A and B from contour intervals is 70 m, and the distance measured between A and B is 560m after converting with the map scale. Using the equations presented above, we can express our slope gradient as

1. As a percent (%) (Equation 15.1):

$$\text{Gradient}(\%) = \frac{\text{Rise, } \Delta z(m)}{\text{Run, } \Delta x(m)} \times 100\% = \frac{70m}{560m} \times 100\% = 12.5\%$$

2. As an angle, θ (degrees) (Equation 15.2):

$$\text{Gradient}(\circ) = \text{Tan}^{-1} \left(\frac{\text{Rise, } \Delta z(m)}{\text{Run, } \Delta x(m)} \right) = \text{Tan}^{-1} \left(\frac{70m}{560m} \right) = 7.1^\circ$$

3. In elevation change per slope distance (m/km) (Equation 15.3):

$$\text{Gradient}(m/km) = \frac{\text{Rise, } \Delta z(m)}{\text{Run, } \Delta x(km)} = \frac{70 \text{ m}}{\left(\frac{560 \text{ m}}{1000 \text{ m per km}} \right)} = 125 \text{ m/km}$$

If you don't have a calculator with trigonometric functions, you can use an online Arctan Calculator (https://www.rapidtables.com/calc/math/Arctan_Calculator.html) to find the inverse tangent. You will need to divide the rise by the run ($70 \div 560$) as an input for this particular calculator.

Notice that in Figure 15.8 the horizontal distance separating A and B (i.e. Δx) is not the actual ground distance. The true distance from A to B is along the hypotenuse of the triangle in Figure 15.8. For small slope gradients the difference between A-B distance and Δx is negligible, but in steep terrain the A-B distance will be significantly longer than Δx .

Finally, when deriving slope steepness from a map you must measure Δx along a line that is perpendicular to the contours. This gives the **true slope**, equivalent to the fall line – think of the direction that water would run down a slope: it would move down the steepest, most direct path, and not deviate along lower-angled routes. In Figure 15.9, true slopes are shown with red arrows. Notice how the red arrows cut across contours at a 90° angle. All other lines crossing the contours represent a **false slope** (blue arrows), which will always be **less** than the true slope. On simple slopes, you may be able to measure Δx along a straight line, but realise that the line of true slope will often be curved, as in Figure 15.9.

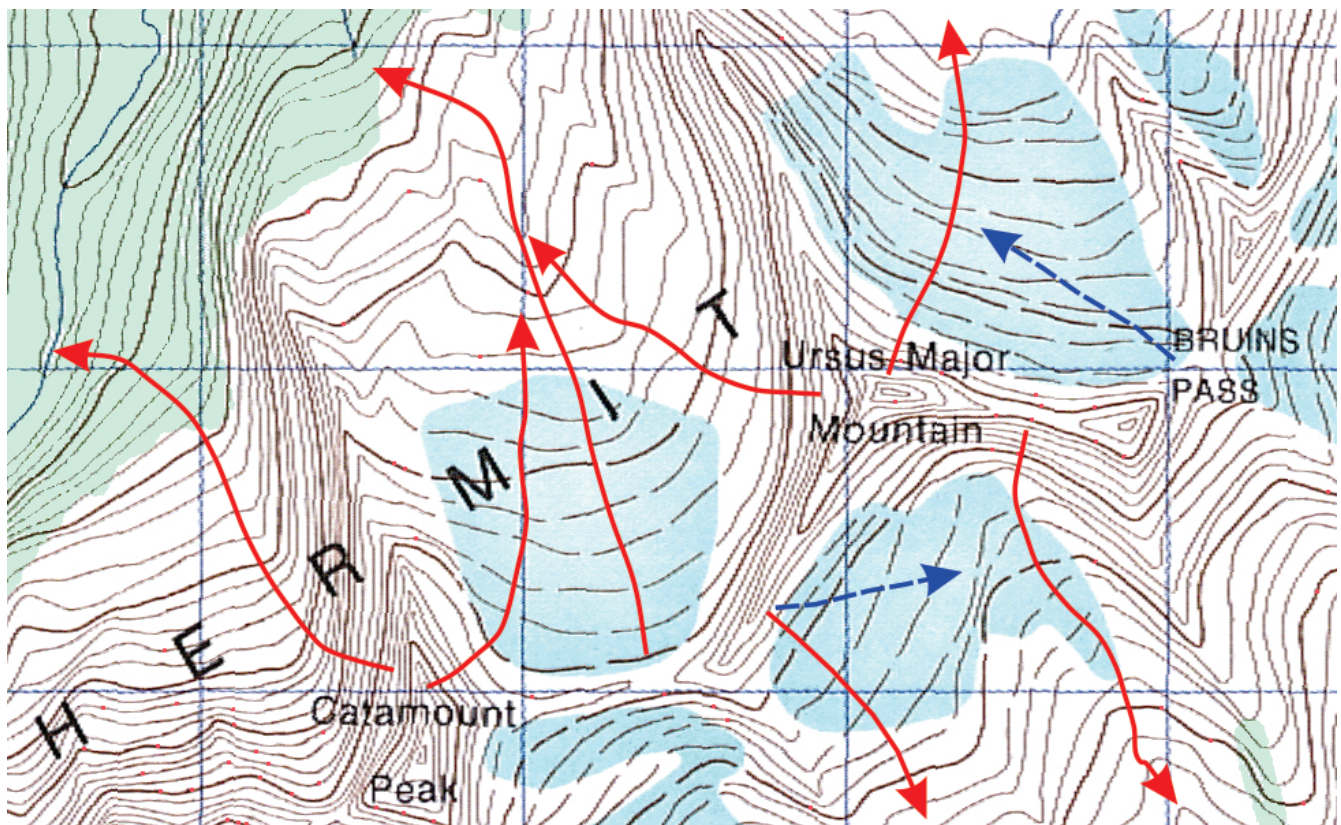


Figure 15.9. Examples of true (red solid arrows) and false (blue dashed arrows) slopes. This figure is a segment of Figure 15.5. Arrows point downhill. Source: I. Saunders, CC BY-NC-SA 4.0. Base map: Natural Resources Canada (http://ftp.geogratis.gc.ca/pub/nrcan_rncan/raster/topographic/50k/082/n/05/), Open Government License-Canada (<https://open.canada.ca/en/open-government-licence-canada>).

Topographic Profiles

A **topographic profile** (Figure 15.10) is a cross-sectional diagram through the landscape, which helps us envisage the nature of the terrain. A profile line might be a simple straight line (which generates a **simple profile**), or a series of straight lines connected at angles to each other (which generates a **compound profile**), or more or less any other continuous line, straight or curved. If we used a profile line that cross all of the contours at right-angles, we would have a **transverse profile**. The longitudinal profile of a river is a transverse profile familiar to geomorphologists and hydrologists.

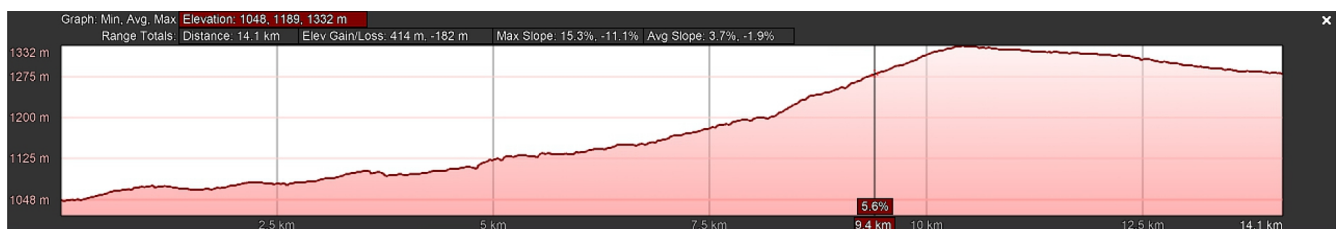


Figure 15.10. Topographic profile of the length of the Trans Canada Highway shown in Figure 15.5. Source: Google Earth, used in accordance with Google Earth Guidelines (<https://www.google.com/permissions/geoguidelines/>).

Topographic profiles are commonly employed to simply show the ups and downs along a particular line (often used in depicting the slopes along a hiking trail). They may also be a bit more complicated

like a cross section and show the subsurface geology, such as the way rock strata tilt and/or fold beneath Earth's surface.

It is common to find that topographic profiles are vertically exaggerated (stretched in the vertical direction) to better depict the subtleties of the terrain. Vertical exaggerations of up to about 3x are common; anything more than this tends to make every little bump in the landscape look like hills and mountains!

Vertical exaggeration (VE) is determined as (Equation 15.4):

Equation 15.4

$$VE = \frac{\text{vertical scale}}{\text{horizontal scale}}$$

Vertical Exaggeration Sample Calculation (Try It!)

- A topographic profile is derived directly from a profile line on a 1:50,000 map. What is the horizontal scale?
 - **Answer: The horizontal scale is 1:50,000.**
 - The horizontal scale is the same as the map scale.
 - The vertical axis of the topographic profile is 5 cm high and represents an elevation range of 1000 m. What's the vertical scale?
 - This can be written as 5 cm : 1000 m. Now convert m to cm so the units are the same on either side: There are 100 cm in 1 m, so $1000 \times 100 = 100,000$ cm. This gives the ratio 5 cm : 100,000 cm. The units are the same on both sides, so they can be dropped, giving 5:100,000. Finally, simplify the fraction by dividing both sides by 5, to give 1:20,000
 - **Answer: The vertical scale is 1:20,000**
 - Using the horizontal and vertical scales, what is the vertical exaggeration?
 - Vertical exaggeration = Vertical Scale / Horizontal Scale
 - $1/20,000 / 1/50,000 = 2.5$
 - This means the relative relief seen in the topographic profile is 2.5 times greater than it actually is in reality. The greater the vertical exaggeration, the steeper any given slope appears to be on the profile.
-

Interpreting the Landscape

The value of topographic maps in allowing us to see the three-dimensional landscape on a two-dimensional map sheet cannot be underestimated. It is a valuable skill, but one that for most people does not come easily. Practice, practice, practice!

Lab Exercises

In this lab you will practice

- Defining direction.
- Interpreting elevation from contour lines.
- Calculating slope gradient.
- Drawing and interpreting topographic profiles.

You will need a calculator, plus an internet connection to download a map and access Google Earth. Some of the exercises may be easier if you are able to print the relevant portion of the map. It is assumed that you have successfully completed Lab 14. It is also assumed that you can convert between metres and feet. The exercises should take you 1½ to 3 hours to complete.

EX1: Directions

1. Use Figure 15.5.
 - a. Derive the grid declination for the current year using the declination diagram shown in the inset of Figure 15.5.
 - b. Assume that you travel through the Connaught Tunnel, from the SW end to the NE end. On the map, the tunnel is at angle 34° from the UTM grid. Derive all three azimuths. When calculating the magnetic azimuth, use the current year's grid declination that you found in 1(a). Round off all final answers to integers.
 - i. Grid azimuth
 - ii. True azimuth
 - iii. Magnetic azimuth
 - c. Assume that you are at the motel at Rogers Pass and see an interesting-looking mountain peak but don't know which one it is. You take a compass bearing of 282° . Use this information and your grid declination from 1(a) to determine which mountain peak you are looking at.

EX2: Elevation & Contours

All questions in EX2 refer to Figure 15.5.

2. Study Figure 15.5 and determine (use the correct units):
 - a. The contour interval.
 - b. The interval between the index contours.
3. Noting that 1 m = 3.281 feet, estimate:
 - a. The elevation (in metres) of Ursus Major Mountain.
 - b. The elevation (in metres) of Rogers Pass.
 - c. Which of the two estimates, Q3a or Q3b, is probably the least accurate? Why?
4. Find the Tupper Glacier. The long-dashed lines across the glacier are approximate contours. Why has the cartographer chosen to depict the surface topography of the glacier using this type of contour?
5. Find the creek at 585807. It appears to simply stop! No, this is not a cartographic error. What happens to it? **Hint: interpret the nearby contour lines.**

EX3: Slope Gradients

6. Find the average gradient between the historic site at Rogers Pass (the diamond symbol at 642818) and the summit of Mount Cheops at 616812 using Figure 15.5. You can assume that a straight line between these two points is the true slope. Express the slope steepness as:
 - a. A percentage.
 - b. An angle in degrees.
 - c. Elevation change per slope distance.
7. The Connaught Tunnel, which carries a rail line beneath Rogers Pass, is about 8080 metres in length. Its northeast portal is at an elevation of 3600 feet (not shown on the map). The southwestern portal is at approximately 644797 on Figure 15.5. What is the average slope of the tunnel? Express it as an angle in degrees correct to two decimal places.

EX4: Topographic Profiles

8. Figure 15.11 is a topographic profile of a short hiking trail in the Okanagan region of BC. It is posted at the trailhead so that hikers can see what's in store for them.

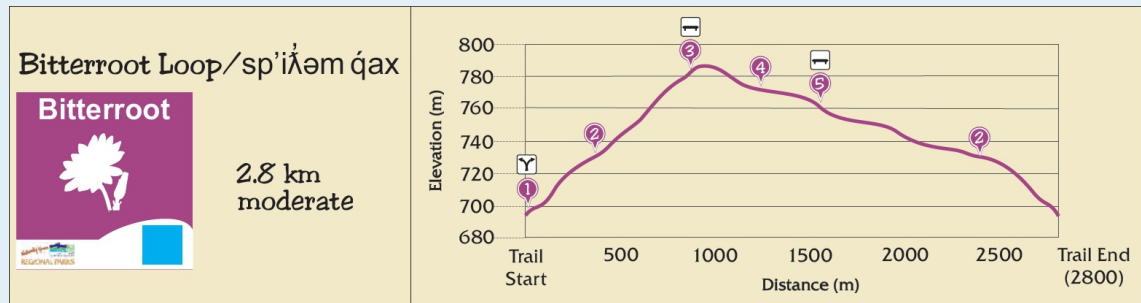


Figure 15.11. Topographic profile of the Bitterroot Loop trail. Source: Rose Valley Regional Park (<https://www.regionaldistrict.com/your-services/parks-services/parks-and-trails/12-rose-valley-regional-park.aspx>) kiosk information, used here with permission from the Regional District of Central Okanagan. [Image description]

- a. The trail looks very steep in places, but this might be due to the vertical exaggeration (VE). Determine the VE to find out. **Hint:** you can measure the lengths of each axis from the screen and apply the generic scale formula from Lab 14 Map Scales to find the scales of the vertical and horizontal axes.
 - b. Determine the average gradient between point 1 (**Trail Start**) and point 3 (highest point). Express the slope steepness as
 - i. A percentage
 - ii. An angle in degrees
 - iii. Elevation change per slope distance
 - c. Now that you have done these calculations, do you think the trail is very steep? Why/why not?
9. You have decided to walk across the Illecillewaet River valley shown on Figure 15.5. Your route will take you from Napoleon Spur at 625806 to Marion Lake at 645786 to experience topography first-hand. Although you are prepared for the hike, your friends are concerned that it will be too steep for them.
- a. Draw a topographic profile on graph paper to convince them they can do it. You will need to print out Figure 15.5, and if you do not have any on hand, **graph paper**, found in Worksheets. If you require further guidance, please watch these step-by-step video instructions on obtaining data from topographic maps (<http://www.youtube.com/watch?v=VgqdTBmoSCQ>) and constructing a topographic profile on graph paper (<http://www.youtube.com/watch?v=hGUbGF9k3gM>).
 - b. If you were not limited by paper size, how would you alter your cross-section to make it easier to convince your friends to join you?
 - c. What is one advantage of taking a paper map with you on the hike compared to an electronic one?

EX5: Creating Topographic Maps

10. Create your own topographic map. As outlined in Contour Lines, contour lines are lines of equal elevation that are interpreted from ground surveys and analyses of satellite images. You have been tasked with creating a topographic map of Acme Creek. Download and print out **Map of Spot Heights at Acme Creek** found in Worksheets. This document contains spot heights and a graphical scale, and the solid lines already on the map are streams. For further guidance on creating a topographic map from spot heights, please watch this step-by-step video instruction [Drawing Contour Lines on a Topographic Map](https://www.youtube.com/watch?v=CCPmculoLkpU) (<https://www.youtube.com/watch?v=CCPmculoLkpU>).
- Draw and label contour lines on the map at 25 m intervals between 350 m and 475 m.
 - Calculate the scale of the map.

Upload a scan of your complete map as your answer to this question.

Reflection Questions

- Many people rely on their GPS receiver to provide locational and directional information. But GPS receivers can go wrong, or get broken or lost. In 3 – 5 sentences, explain how you would use a map and compass to find your way when the high-tech equipment is no longer an option.
- You want to hike to the top of a mountain but it looks steep and you want to find the easiest (least-steep) route. You open up Google Earth (Web) and know that you can get elevation values for the top of the mountain and a number of points along the base of the mountain. Using the **Measure** tool for horizontal distances, explain how you could determine the slope of the route options and find the best route?
- A topographic profile is a useful tool for looking at topography of interest. How could you see yourself using this tool outside of this course?

Worksheets

Figure 15.5

- Figure 15.5 [PDF] (<https://pressbooks.bccampus.ca/geoglabmanualv2/wp-content/uploads/sites/1340/2020/09/Lab-15-Figure-15.5.pdf>)
- Figure 15.5 [WORD] (<https://pressbooks.bccampus.ca/geoglabmanualv2/wp-content/uploads/sites/1340/2020/09/Lab-15-Figure-15.5.docx>)
- Figure 15.5 [ODT] (<https://pressbooks.bccampus.ca/geoglabmanualv2/wp-content/uploads/>)

sites/1340/2020/09/Lab-15-Figure-15.5.odt)

Graph paper

- Lab 15 Graph paper [PDF] (<https://pressbooks.bccampus.ca/geoglabmanualv2/wp-content/uploads/sites/1340/2020/09/Lab-15-Graph-paper-to-print.pdf>)

Map of Spot Heights at Acme Creek

- Map of Spot Heights at Acme Creek [(<https://pressbooks.bccampus.ca/geoglabmanualv2/wp-content/uploads/sites/1340/2020/09/Lab-15-Map-of-Spot-Heights-at-Acme-Creek.pdf>)PDF] (<https://pressbooks.bccampus.ca/geoglabmanualv2/wp-content/uploads/sites/1340/2020/09/Lab-15-Map-of-Spot-Heights-at-Acme-Creek.pdf>)
- Map of Spot Heights at Acme Creek [WORD] (<https://pressbooks.bccampus.ca/geoglabmanualv2/wp-content/uploads/sites/1340/2020/09/Lab-15-Map-of-Spot-Heights-at-Acme-Creek.docx>)
- Map of Spot Heights at Acme Creek [ODT] (<https://pressbooks.bccampus.ca/geoglabmanualv2/wp-content/uploads/sites/1340/2020/09/Lab-15-Map-of-Spot-Heights-at-Acme-Creek.odt>)

Supporting Material

How to Find True Slope Along Topographic Profiles

Unless the vertical exaggeration of the profile is 1.0 (i.e. horizontal and vertical scales are the same), slope gradients will not be realistic. They will have to be derived by finding the rise and run of a tangent as shown by the example of a hiking trail in BC on Figure 15.12.

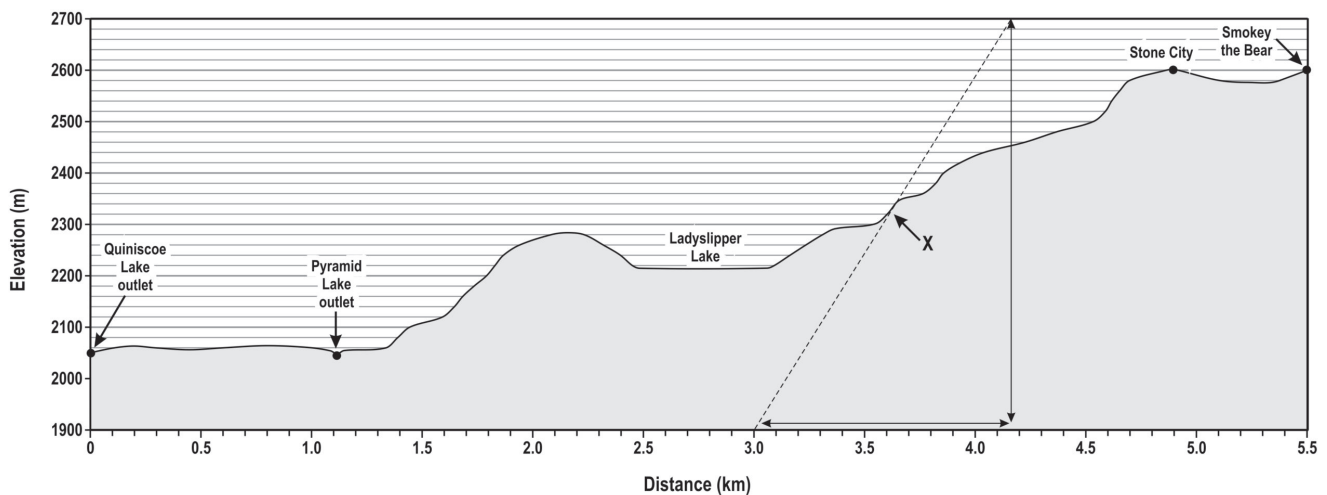


Figure 15.12. Vertically exaggerated topographic profile of a hiking trail in BC. The dashed line indicates the true slope at point X. Source: I. Saunders, CC BY-NC-SA 4.0.

Assume that we want to find the true slope gradient at point X.

Step 1. Draw a tangent through the topographic profile (the sloping dashed line).

Step 2. Find the rise (Δz) and run (Δx) of the line. Here $\Delta z = 800$ m and $\Delta x = 1150$ m.

Step 3. True slope gradient:

$$\text{Gradient}(\text{°}) = \text{Tan}^{-1} \left(\frac{\text{Rise, } \Delta z(m)}{\text{Run, } \Delta x(m)} \right) = \text{Tan}^{-1} \left(\frac{800m}{1150m} \right) = 35.0^\circ$$

Note how the slope of the dashed-line tangent is much steeper in Figure 15.12 than 35° because of the vertical exaggeration of the profile.

Downloading NTS Topographic Maps

Option 1: If you don't know the map sheet's number. Access the GeoGratis Topographic Information website (<http://www.geogratis.gc.ca>) and select the **Geospatial Product Index – HTML**. You can then zoom in or out of the map and the map codes will appear. For example, zoom in on Vancouver. You will first see **92** appear, then a grid with letter codes, and then number-letter-number codes which are the 1:50,000 map IDs; downtown Vancouver is map sheet **92G06**. You may get access to the maps directly from here, but if not, record the map sheet number and go to Option 2.

Option 2: If you know the map sheet's number. Use GeoGratis's ftp site for 1:50,000 map sheets (http://ftp.geogratis.gc.ca/pub/nrcan_rncan/raster/topographic/50k/). You will probably find that the **canmatrix_geotiff** versions are the easiest to use. Alternatively, *.tif and *.pdf files are also available. These are all scanned versions of the original NTS map sheets.

Image Description

Figure 15.8. Fundamental elements of a slope.

A schematic diagram that represents a hillslope with a right-angle triangle. The components necessary to calculate the slope gradient between the lowest point, Point A, and the highest point, Point B are also identified. The line from Point A to Point B is the hypotenuse of the triangle. This is the line for which the slope gradient is to be calculated. The slope gradient is calculated by measuring the horizontal distance between Point A and Point B (delta x), which is also known as the “run”, and the vertical difference between Point A and Point B, or elevation change (delta z) which is also known as the “rise”. The right-angle of the triangle is formed where lines drawn horizontally from Point A and vertically from Point B connect. The slope gradient can also be expressed as an angle, theta, the angle between the horizontal line and the slope of interest.

[Return to Figure 15.8]

Figure 15.11. Topographic profile of the Bitterroot Loop trail.

An example of a trail map that may be found at a trailhead. The left panel of the image is the name of the trail in English and nsylxcen, and the distance and difficulty of the trail. The Bitterroot Loop is 2.8 kilometres long and of moderate difficulty. The right panel is a topographic map that depicts the change in elevation along the length of the trail. Elevation in metres is on the y axis and distance along the trail

in metres is on the x axis. The trail starts and finishes approximately 695 m in elevation and rises to 785 m elevation over a total distance of 2800 m.

[Return to Figure 15.11]

Lab 16: Measuring and Analyzing Slope

Katie Burles and Crystal Huscroft

In this lab you will be doing a combination of field and office-based analyses of topographical slope. In the field, your technique will simulate a quick low-cost method of approximating slope, and your office-based analysis is typical of preliminary office-based investigations.

Slope is a measure of change in elevation over a known horizontal distance. Often it is used to describe the steepness of a landform surface. One might argue that slope is one of the most significant landscape metrics for geographers to evaluate.

Much of Earth's surface is sloping, not flat, and as a consequence there are a range of hydrological and geotechnical processes that are activated by the difference in **potential energy** between one location and another. Potential energy is the energy available to for doing work. For example, an object that is lifted above Earth's surface to height H can be moved downward a distance H by gravity. Slope processes bridge several scientific fields such as geomorphology, soil science, hydrology, and engineering.

In this lab you will gather your own field measurements at a location of your choosing, and learn the basics of taking high quality field notes to support your field measurements. Then you will input your field measurements into Google Earth (Web) to help calculate the slope you observed in the field. Finally, using a Geographic Information System (GIS), you will measure the gradient of a ski run at a resort of your choosing, plot the vertical profile and produce a short report summarizing your findings.

Learning Objectives

After completion of this lab, you will be able to

- Plan and execute independent field work.
- Record complete, well-formatted and well-organized field notes.
- Perform a basic surveying measurement in the field.
- Measure elevation and distance using online GIS platforms.
- Calculate slope gradient using a spreadsheet program.
- Generate slope profiles using a spreadsheet program.
- Relate field observations of gradient to calculated values of gradient.

Pre-Readings

Why Is Slope Analysis Important to Geographers?

Important applications for slope analysis include describing landforms, watershed modelling, characterization of wildlife habitat, assessing slope stability and mass wasting hazards, classifying soil development, modelling wildfire risk, and assessing potential for land use development.

Recording Field Notes: General Guidance

In the field you must be very neat and organized in recording information. In professional settings, notebooks are used as evidence that you used proper procedures and conducted yourself professionally by collecting all the relevant information. Occasionally, field notes are entered into legal proceedings as evidence in support of proper professional processes. It is important to start early in one's career with taking well formatted, complete, and proper notes. Field notes will be the only recorded evidence of what you saw and did in the field. There is a saying, **“if it is not in your field notes, it never happened”**. Moreover, human memories are surprisingly unreliable, and it will take only a matter of a few days before you have completely forgotten the details of what you did in the field. Field notes are invaluable in this regard.

In professional settings, erasing mistakes is regarded as tampering with field notes. As such, you may not erase mistakes or cover them with white-out. Instead, neatly cross out any incorrect measurements. You never know if or how your observations and measurements will be useful later.

Surrounding Information

In the field, you will be recording GPS position, vertical distance measurements, and photographic images. However, before you take these measurements, there are other important pieces of information to be recorded. Surrounding information is always included so that the measurements become meaningful to other colleagues, employees, or researchers that read your values. This surrounding information includes:

- Location (coordinates and verbal description of relative position to major landmarks nearby);
- Date & time;
- Participants (include who is in the field and their roles);
- Weather (as the weather will influence the quality of your observations, measurements, and notes); and
- A description of your overall goal for this field stop.

Photographs

You will be taking photographs for this assignment and they will need to be recorded (remember that professionally, if a record of taking a photo is not in your field notes, the picture was never taken). If you take a photo, the following details should be included:

1. File number (time of the photo is fine if you are using a cell phone).
2. Approximate compass direction the camera was pointing.
3. If there is an object for scale so that the viewer of the photograph can tell how large items are in the photo.
4. The subject of the photograph and any other information that is important for understanding why you took the picture.

Field Measurements of Elevation Change (Vertical Distance) Using Levelling

As previously mentioned, slope is a measure of change in elevation over a known horizontal distance. A **sighting level** is a device that allows a user to be able to aim their view along a true horizontal line. Using a sighting level and a known eye height to measure the change in vertical elevation between two points is an ancient technique that early civilizations used to design aqueduct and irrigation systems. It is also a modern technique used in professional settings, except that much more sophisticated digital surveying equipment is used.

We will be using GPS readings of horizontal position built into a smartphone to determine the change in horizontal position. So, you might wonder, why not use the GPS to determine the change in vertical distance too? Although handheld GPS-based measurements of horizontal position are typically accurate to within roughly 10 m, errors in vertical position are typically 2-3 times greater. Therefore, using a level to determine vertical distance can improve approximate measurements of slope over using handheld GPS measurements alone.

As seen in Figure 16.1, if a level is used to sight a series of target locations on the ground (Point x_1 through to Point A'), and the level's elevation above the ground (z) is known, the vertical distance (Δz) from A to A' can be measured. The vertical distance (Δz) is also known as the **rise** of the slope from A to A' .

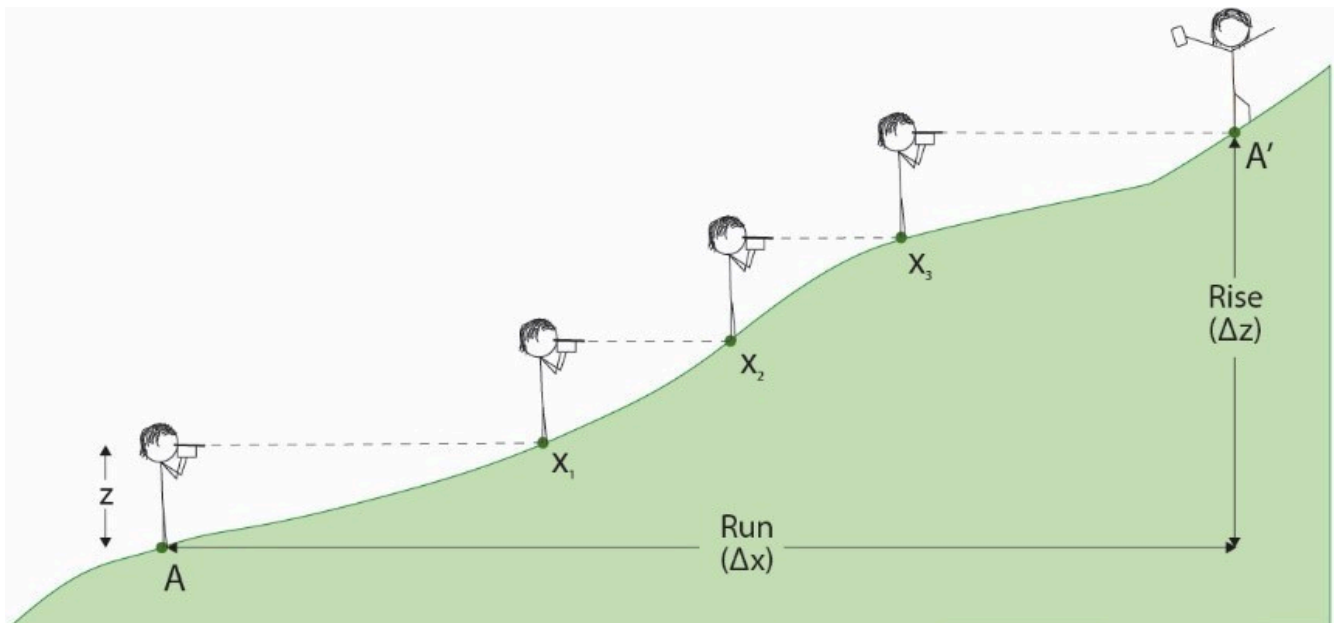


Figure 16.1. Sketch profile of the levelling methodology. The surveyor, with a sighting height of z , progresses up slope from A to A' with intermediate stations x_1 , x_2 , and x_3 . The vertical distance is the sum of the number of sighting heights (z). Source: C. Huscroft, CC BY-NC-SA 4.0.

No matter the type of level that you use, there are several steps that are common to all levelling measurements of elevation change:

1. Measure the height between the ground and your instrument (z).
2. Start downhill and work your way uphill.
3. At the starting point A , sight along the edge of your level, as though you are aiming an arrow with precision toward the slope in order to locate your next sighting position (x_1). If you have a field partner, they can landmark the position of your target (x_1 , x_2 , etc.) for you.

Using a GPS to Record Horizontal Position

The Global Positioning System (GPS) uses the relative distance of a ground-based receiver to a constellation of satellites to triangulate and locate the receiver's position on the Earth's surface. Almost all cell phones are equipped with GPS-receiving technologies and they can be used in a fashion similar to a hand-held GPS receiver that is designed for terrestrial or marine navigation. Handheld systems are convenient to carry, give rapid readings with reasonable accuracy, and allow the user to record digital information about way points and paths.

As mentioned previously, handheld GPS-based measurements of horizontal position are typically accurate to within roughly 10 m under ideal conditions. However, errors in vertical position are typically 2-3 times greater. Ideal conditions include an open view of the sky without blockage due to buildings, bridges and trees so that the receiver can obtain signals from as many satellites as possible. A more in-depth description of GPS is described in the pre-readings to Lab 13 of this manual.

Calculating Slope Gradient

Your fieldwork and ski hill analyses will involve collecting data in order to analyze slope. In the first part of this lab you will obtain measurements of rise and run using a combination of levelling and GPS measurements. In the second part of the lab, you will extract this data from maps. After recording your field measurements, it is time to crunch some numbers. The **gradient** of a ground surface is calculated by the difference in elevation between two points on a slope (rise, Δz) divided by the horizontal distance between the two points (run, Δx). These two points are labelled as A and A' on Figure 16.2, just as they are on Figure 16.1.

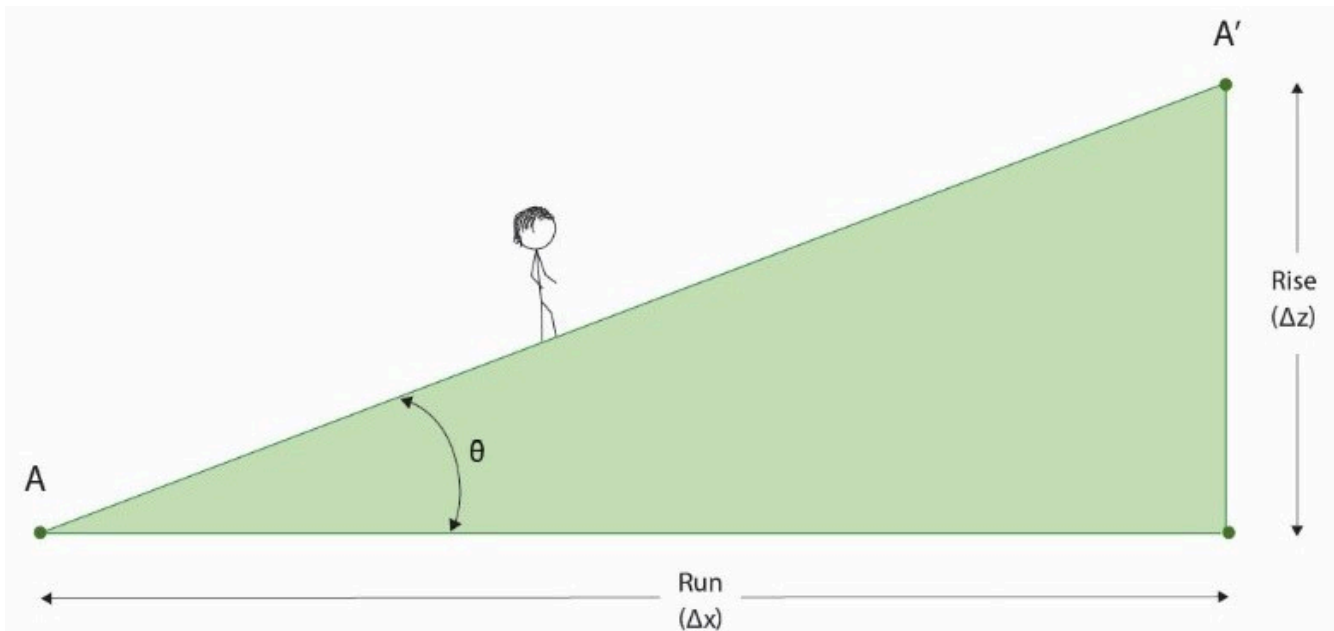


Figure 16.2. Fundamental elements of a slope. The run (Δx) represents the horizontal distance that is visible in map view between points A and A'. The rise (Δz) represents the vertical distance between points A and A'. Source: C. Huscroft, CC BY-NC-SA 4.0.

After obtaining the vertical elevation change (rise, Δz) and the horizontal distance (run, Δx) between two points, slope gradient can be calculated and expressed in three ways:

1. As a percent (%): the fraction (rise \div run) expressed as a percentage (Equation 16.1):

Equation 16.1

$$\text{Gradient}(\%) = \frac{\text{Rise, } \Delta z(m)}{\text{Run, } \Delta x(m)} \times 100\%$$

2. As an angle, θ (degrees) (Equation 16.2):

Equation 16.2

$$\text{Gradient}(\circ) = \text{Tan}^{-1} \left(\frac{\text{Rise, } \Delta z(m)}{\text{Run, } \Delta x(m)} \right)$$

3. In elevation change per slope distance (m/km): the gradient expressed with different units used for **rise** and **run**, but with the **run** always reduced to one unit, commonly 1 km (Equation 16.3).

Equation 16.3

$$\text{Gradient}(m/km) = \frac{\text{Rise, } \Delta z(m)}{\text{Run, } \Delta x(km)}$$

For example, let us assume that the elevation change we measured levelling between points A and A' added up to 5 m, and the horizontal distance we measured between our GPS points using Google Earth is 200 m (Figure 16.3).

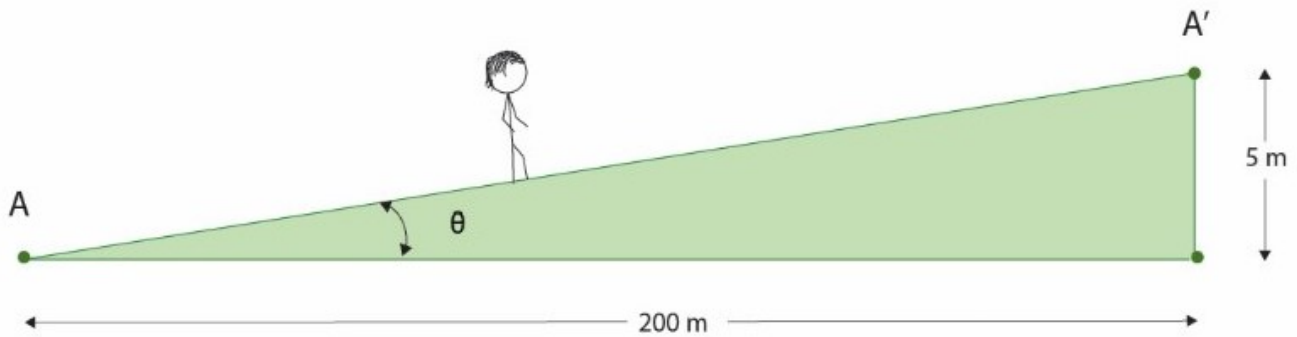


Figure 16.3. Sample values for the fundamental elements of a slope. In this example, the run (Δx) has a value of 200 m and the rise (Δz) has a value of 5 m between points A and A'. Source: C. Huscroft, CC BY-NC-SA 4.0.

Using the equations presented above, we can express our slope gradient

1. As a percent (%) (Equation 16.1 (#eqn16.1)):

$$\text{Gradient}(\%) = \frac{\text{Rise, } \Delta z(m)}{\text{Run, } \Delta x(m)} \times 100\%$$

$$\text{Gradient}(\%) = \frac{5 \text{ m}}{200 \text{ m}} \times 100\% = 2.5\%$$

2. As an angle, θ (degrees) (Equation 16.2 (#eqn16.2)):

$$\text{Gradient}(\circ) = \text{Tan}^{-1} \left(\frac{\text{Rise, } \Delta z(m)}{\text{Run, } \Delta x(m)} \right)$$

$$\text{Gradient}(\circ) = \text{Tan}^{-1} \left(\frac{5 \text{ m}}{200 \text{ m}} \right) = 1.4^\circ$$

3. In elevation change per slope distance (m/km) (Equation 16.3):

$$\text{Gradient}(m/km) = \frac{\text{Rise, } \Delta z(m)}{\text{Run, } \Delta x(km)}$$

$$\text{Gradient}(m/km) = \frac{5 \text{ m}}{\left(\frac{200 \text{ m}}{1000 \text{ m per km}}\right)} = 25 \text{ m/km}$$

Low gradient slopes are almost flat and have very little slope, whereas **high gradient** slopes have steep slopes.

Lab Exercises

This lab includes two exercises that result in creating an assignment to be handed in as a report in PDF format. The submitted report will include a series of required figures with captions.

Exercise 1 is partially field-based and will take approximately 3 hours to complete once you have found an appropriate field location (including report preparation but excluding travel time).

Exercise 2 is office-based. This exercise will take approximately 3 hours to complete. The length of time allocated to this exercise will depend on familiarity using Google My Maps, iMapBC, and Microsoft Excel.

Required materials:

- Tape measure or ruler.
- GPS equipped cell phone. Refer to your cell phone's user guide. Almost all new phones are equipped with GPS capabilities. You may wish to choose an app set to record locations in decimal degrees.
- Material to construct a sighting level (see Appendix A).
- Pencil and field book or paper and a hard surface (clip board) to write on.
- Camera (cell phone is fine).

Required software:

- Google Earth (Web) – not mobile version.
- Spreadsheet software (Excel, Numbers, or Google Sheets).
- GPS App on your phone that preferably allows confirmation of communication with enough satellites. iPhones may use the compass tool if location services in your privacy settings is enabled. GPS Diagnostic (<https://apps.apple.com/us/app/gps-diagnostic-satellite-test/id1020967894>) is recommended and used by professionals, but costs a few dollars. Google Play offers GPS Satellites Viewer (https://play.google.com/store/apps/details?id=com.stgrdev.gpssatellitesviewer&hl=en_US&gl=US) for free.

- Mobile levelling app for a phone/tablet or a level constructed from craft supplies (see Appendix A).
- iMap BC website (no user name required).

EX1: Determining Slope in the Field and Using Google Earth (Web)

Safety: Do not complete this exercise until receiving a safety briefing and completing the proper paperwork (if applicable) from your lab instructor. In addition, your first goal when you arrive at a site is to ascertain whether the terrain is safe.

At Home Preparations

Step 1: Choose an Easily Accessible Slope.

Choose a slope that you can easily visit. This slope needs to be

- relatively steep with an elevation change at least twice your height,
- open (no obstructions to your view from the top to the bottom of the slope), and
- at least 100 m long.

Safe sidewalks and pedestrian overpasses with no intersections are appropriate, grassy hillsides as well as open and straight sections of trail are also good.

Step 2: Construct Your Level

Using the instructions in Appendix A, build your sighting level.

Step 3: Measure Your Eye Height

Wearing the shoes that you will likely wear during fieldwork, measure the elevation of your eyes above the ground when looking level. If you do not have someone that can help you, or if you do not have a tape measure, stand beside a door frame and lightly mark the position of your eye height with a pencil by using your level to sight on the door frame. Use a ruler or tape measure to measure the elevation of your eyes.

Step 4: Print or Copy Down the Field Notes Template

If you have access to a printer, print out the Field Notes Template in Worksheets to bring to the field. If you do not have access to a printer, copy the necessary information into your field notebook. This will be your Field Notes Worksheet.

Field Work

Step 1: Travel to the Field Site and Start Field Notes

After choosing a slope to measure, walk to the base of your slope. You will call this location **Point A**.

Record the surrounding information on your Field Notes Worksheet (participants, date, time, goal of fieldwork).

Step 2: Plan and Document Your Transect (Figure EX1.1)

Plan where you will start and approximately where you will end your slope measurement (location of **Point**

A and **Point A'**). If you are using an open slope, it is best to travel directly up-slope (i.e., along the steepest trajectory) and not across the slope.

Document this plan by taking a photograph with your downhill start point (**A**) in the foreground and your approximate end point (**A'**) in the background. This will be Figure EX1.1 in your lab report (see the example in Figure 16.4). Record all pertinent photograph information (time or file number, direction of view, subject, verbal location description) about the photograph on your Field Notes Worksheet.

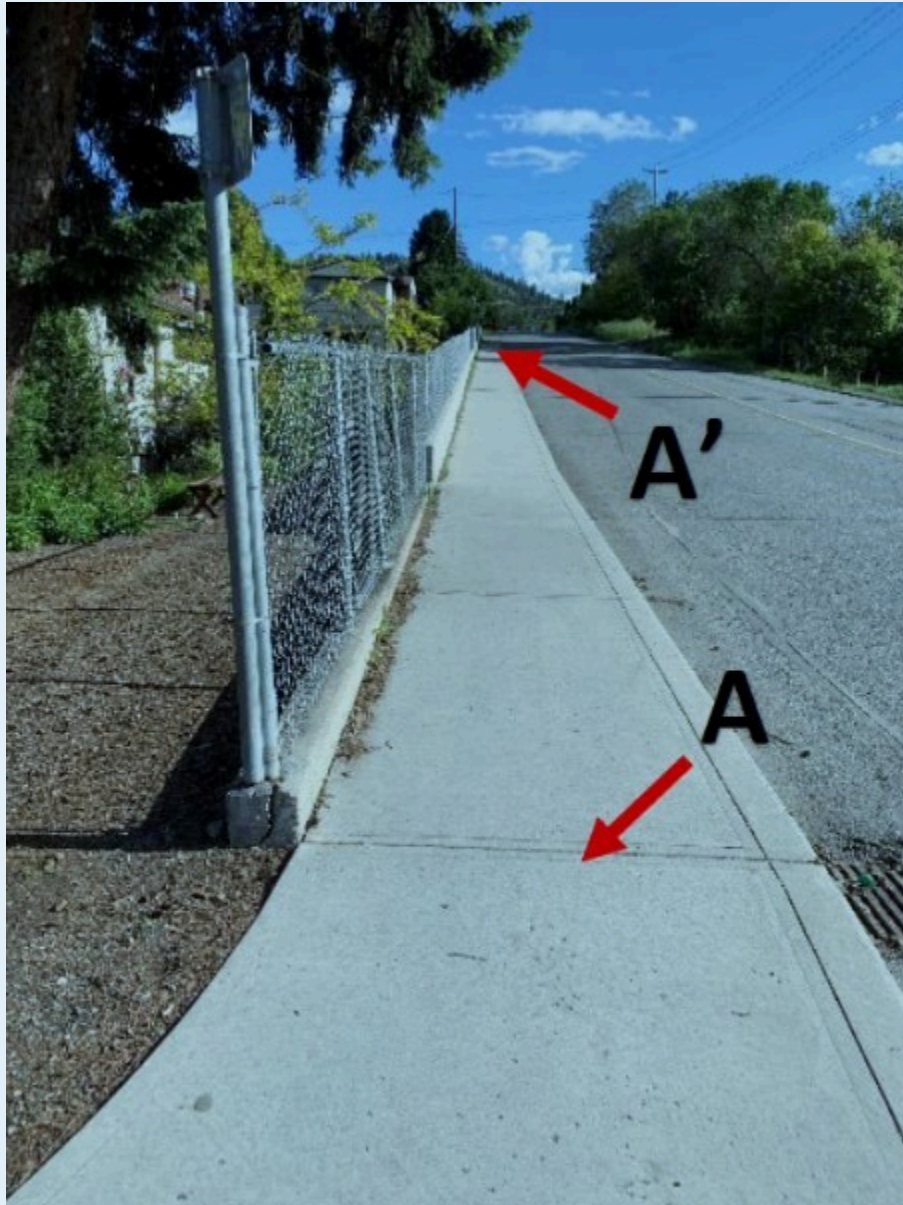


Figure 16.4. Example Figure EX1.1. Photograph of entire slope used in Exercise 1. This is a photograph looking southward up slope from **Point A** to **Point A'** along 6th Avenue in Kamloops BC between Dominion Street and Pine Street. Source: C. Huscroft, CC BY-NC-SA 4.0.

Step 3: Document Point A (Figure EX1.2)

While standing at **Point A**, record an accurate GPS reading (preferably in decimal degrees) by ensuring that you have at least 4 satellites. This may take a few minutes.

Include a verbal description of where **Point A** is located so that you will be able to tell if your location maps incorrectly into Google Earth.

Use a compass application on your phone to indicate the azimuth of your surveying. Azimuth refers to the compass direction expressed in degrees as a number between 0 and 360. Directions expressed as an azimuth do not include cardinal directions (north, south, east, west and their derivatives). For example, northwest has an azimuth of 305° .

Take an informative photograph of **Point A**. This photograph will be Figure EX1.2 of your report (see the example in Figure 16.5). **Include the information you collect in this step in the figure caption.** It may be helpful to annotate the photograph with the exact location of Point A with an arrow and label, although this can be done after the field with really good descriptions of where exactly you are placing the starting point (**Point A**). Don't forget all the essential photograph information (time or file number, direction of view, subject, verbal location description).



Figure 16.5. Example Figure EX1.2. Photograph of **Point A** (indicated by tip of arrow) looking northward on the southeast corner of 6th Avenue and Dominion Street Kamloops, BC. Source: C. Huscroft, CC BY-NC-SA 4.0.

Step 4: Level Up Towards Point A'

Standing at **Point A** (the base of your slope), use your level to landmark the position on the slope that is perfectly horizontal to your eye height (x_1 in Figure 16.1). Walk to your landmark (x_1) and repeat sighting to the next landmark position on the slope that is perfectly horizontal to your eye height (x_2).

Repeat and record the number of intermediate landmarks required to level up until your next sighting landmark is above your desired endpoint (i.e., where you would overshoot your desired endpoint if you continued). This last position at or above your desired endpoint will be your actual endpoint (**Point A'**).

Step 5: Document and Describe Point A' (Figure EX1.3)

While still standing at **Point A'**, record an accurate GPS reading by ensuring that you have at least 4 satellites. This may take a few moments.

Include in your notes a verbal description of where **Point A'** is located so that you will be able to tell if your measured location maps incorrectly into Google Earth.

Take an informative photograph of your actual endpoint **Point A'**. This photograph will be Figure EX1.3 of your report (see the example Figure 16.6). **Include the information you collect in this step in the figure caption.**

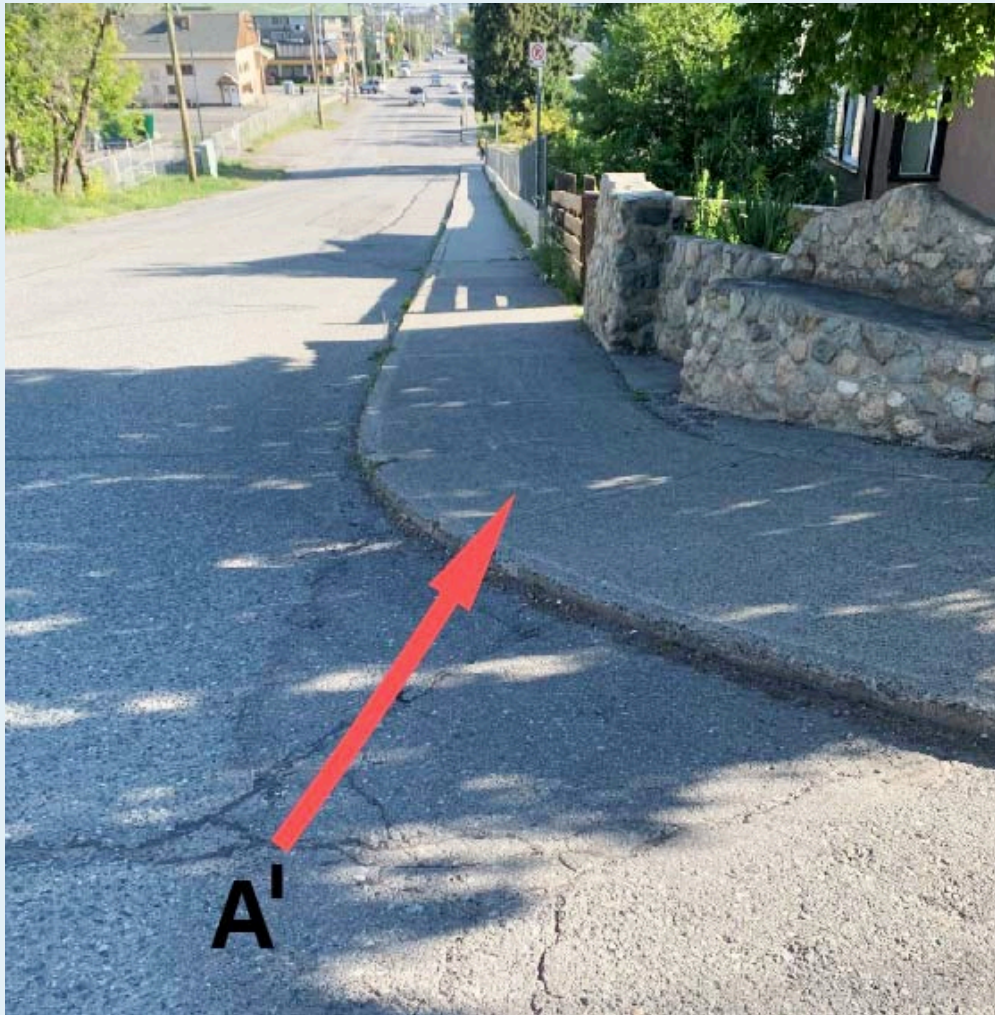


Figure 16.6. Example Figure EX1.3. Location of **Point A'**. Photograph of **Point A'** (indicated by tip of arrow) looking northward. Source: C. Huscroft, CC BY-NC-SA 4.0.

Step 6: Photograph Your Field Notes (Figure EX1.4)

Once you are done your field work, and before you leave the field, take a picture of your field notes in order to create a backup and include them in your report as Figure EX1.4 (see example Figure 16.7). Double-check by zooming into your photograph that your notes are clearly legible. Remember, you must not re-type or change your field notes in any way after you leave the field.

Slope Measurement Field Notes

By Crystal Huscroft

Date: June 17th, 2020 5pm

Weather: Warm sunny evening

Participants: just me

Goal: Measuring the slope on the sidewalk (east side) on 6th Avenue between Dominion and Pine Street Kamloops B.C for Geog 1000 Lab 5

Location	Latitude (DDD.DDDD)	Longitude (DDD.DDDD)	Accuracy value (If applicable)
Start point (A)	50.670587489	-120.327109	± 5m (says app)
End point (A')	50.669701	-120.327055	± 5m " "

≥ 4 satellites
" "

Eye Height (m)	1.60m
Number of eye height measurements to reach A' from A	### 1
Azimuth	170°

Equipment: Using GPS diagnostic App on iPhone XR
Datum: WGS 84

- (PIC) 5:41pm - Iphone - photo of Site A (start point @ base of slope) center of sidewalk in line with bottom post of fence + retaining wall looking north. Not much for scale.
- (PIC) 5:43pm - Iphone - photo of Site A to A', looking south upslope
- (PIC) 6:00pm - Iphone - looking north at Point A'. Point A is in center of sidewalk in front of bench.
- (PIC) 6:05pm - close up of these notes.
- (PIC) 6:08pm - close up of these notes with transect in background looking north.

Rough Sketch map

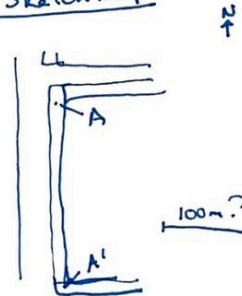
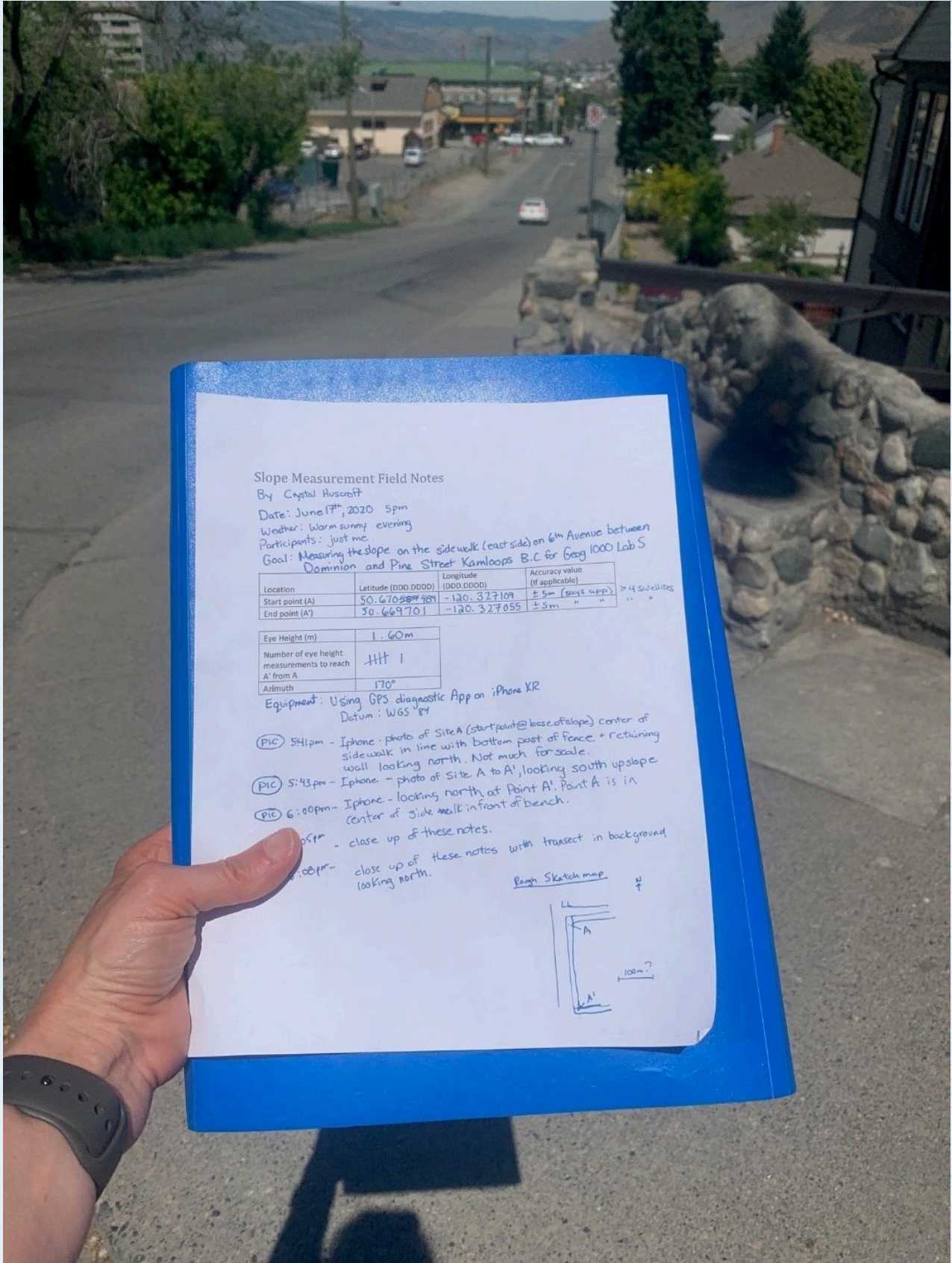


Figure 16.7. Example Figure EX1.4. Field notes. Photograph of field notes taken on June 17th, 2020. Source: C. Huscroft, CC BY-NC-SA 4.0.

Step 7: Re-Photograph Your Field Notes with Transect in Background (Figure EX1.5) and Final Check

Retake a picture of your field notes with the location of your transect in the background as evidence of your work (see example Figure 16.8). Include in your lab report as Figure EX1.5. Before leaving the field, ensure that you are not missing any details in your notes and that you have taken all five of the required photographs.



Slope Measurement Field Notes

By Crystal Huscroft

Date: June 17th, 2020 5pm

Weather: Warm sunny evening

Participants: just me

Goal: Measuring the slope on the sidewalk (east side) on 6th Avenue between Dominion and Pine Street Kamloops B.C for Geog 1000 Lab 5

Location	Latitude (DDD.DDDDD)	Longitude (DDD.DDDDD)	Accuracy value (if applicable)
Start point (A)	50.670587489	-120.327109	± 5m (says app) > 4 satellites
End point (A')	50.669701	-120.327055	± 5m " "

Eye Height (m)	1.60m
Number of eye height measurements to reach A' from A	HHH 1
Azimuth	170°

Equipment: Using GPS diagnostic App on iPhone XR
Datum: WGS 84

- (PIC) 5:41pm - iPhone - photo of Site A (start point @ base of slope) center of sidewalk in line with bottom post of fence + retaining wall looking north. Not much for scale.
- (PIC) 5:43pm - iPhone - photo of site A to A', looking south upslope.
- (PIC) 6:00pm - iPhone - looking north at Point A'. Point A' is in center of sidewalk in front of bench.
- 6:05pm - close up of these notes.
- 6:08pm - close up of these notes with transect in background looking north.

Rough Sketch map

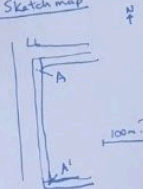


Figure 16.8. Example Figure EX1.5. Field notes with transect in the background. Source: C. Huscroft, CC BY-NC-SA 4.0.

Office Work

Step 1: Determine Horizontal Distance Using Google Earth (Figure EX1.6)

Once back from the field, open Google Earth (Web) (<https://earth.google.com/web/>). Click on the **Projects** menu icon (fifth icon from top in the menu on the left of the screen). Then click **New project** and then **Create KML file**. Name your project <Lastname Firstname Student Number L16 EX1> by entering this into the box containing the text **Untitled Project** next to the pencil icon. Press the blue **New Feature** dropdown menu and choose **Search to add place**.

Input the recorded latitude and longitude of **Point A** and click the **Add to project** button once a placemark has been created.

Repeat the same steps to plot the recorded position of **Point A'**.

Once both **Point A** and **A'** have been plotted, use the **Measure** tool (ruler icon at bottom of menu on left of screen) to determine the horizontal distance between **Point A** and **Point A'**. Create a screen capture of your horizontal measurement that includes the Google icon, camera, coordinates and elevation (see example Figure 16.9). This image will be Figure EX1.6 in your report.

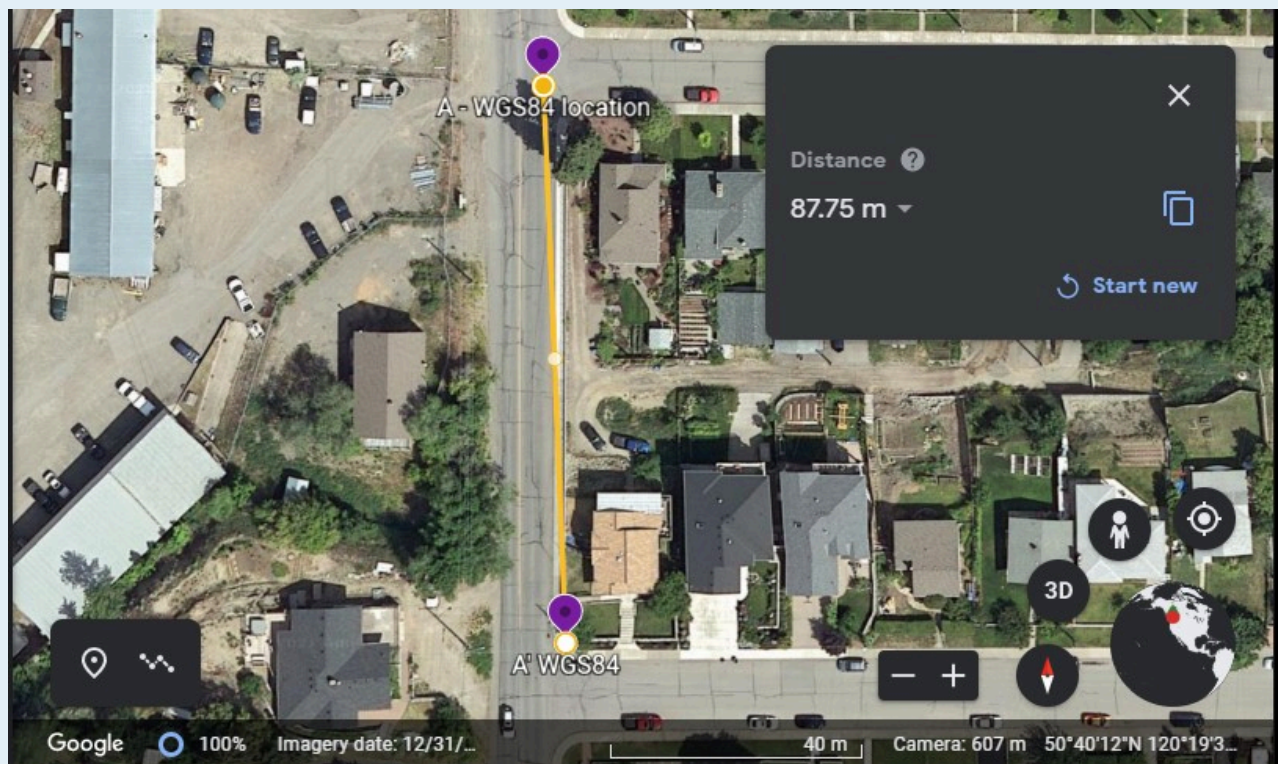


Figure 16.9. Example Figure EX1.6. Google Earth horizontal distance measurement. Screen capture of the measurement of horizontal distance based on field GPS measurements of the locations of **Point A** and **A'**. GPS measurements were made using the datum WGS84. Google Earth imagery uses GWS84 Web Mercator. Source: Google Earth. Used in accordance with Google Earth terms and conditions.

Step 2: Calculate the Gradient

Calculate the vertical distance from **Point A** to **Point A'** by multiplying your eye height by the number of

sightings that you made in order to reach A'. Type out your answer and show your work in a clear table (see example Table 16.1). This will be Table EX1.1 in your report.

Calculate the gradient and express as a percentage, an angle, and as elevation change per km.

$$= \frac{\text{Rise, } \Delta z(m)}{\text{Run, } \Delta x(m)} \times 100\%$$

Table 16.1. Example of Table EX1.1. Gradient Calculations

Calculation	Work (Including Intermediate Steps)	Calculation
Elevation change (field measured)	$= \text{number of eye height measurements} \times \text{eye height}$ $= 6 \times 1.60 \text{ m}$ $= 9.6 \text{ m}$	9.6 m
Gradient (%)	$= \frac{9.6 \text{ m}}{92.15 \text{ m}} \times 100\%$ $= 10.42\%$	10.42%
Gradient (°)	$= \text{Tan}^{-1} \left(\frac{\text{Rise, } \Delta z(m)}{\text{Run, } \Delta x(m)} \right)$ $= \text{Tan}^{-1} \left(\frac{9.6 \text{ m}}{92.15 \text{ m}} \right)$ $= \text{Tan}^{-1} (0.104)$ $= 5.9^\circ$	5.9°
Gradient (m/km)	$= \frac{\text{Rise, } \Delta z(m)}{\text{Run, } \Delta x(km)}$ $= \frac{9.6 \text{ m}}{\left(\frac{92.15 \text{ m}}{1000 \text{ m per km}} \right)}$ $= \frac{9.6 \text{ m}}{0.09215 \text{ km}}$ $= 104 \text{ m/km}$	104 m/km

Step 3: Assemble the EX1 Component of Your Lab Report

Use the list of figures and tables summarized in Table 16.2 to compile the first part of your report. Please ensure that your figures are large enough that they take up at least 75% of the area of a page. Do not forget to include descriptive captions for your figures, and to annotate the photos you use to create figures EX1.1 – EX1.3. Use your field notes to write the site descriptions.

Table 16.2. List of Figures and Tables from Exercise 1 to Include in Your Lab Report. Figure descriptions and example figures included. Use this table as a checklist to make sure you have all of the necessary elements in your report.

Item	Description	Caption (Attribution)
Figure EX1.1	Photograph of entire slope used in Exercise 1, include direction and locations of A and A'	See example Figure 16.4 (Photograph Attribution)
Figure EX1.2	Photograph of Point A location	See example Figure 16.5 (Photograph Attribution)
Figure EX1.3	Photograph of Point A'	See example Figure 16.6 (Photograph Attribution)
Figure EX1.4	Field notes	See example Figure 16.7 (Photograph Attribution)
Figure EX1.5	Field notes with transect in background	See example Figure 16.8 (Photograph Attribution)
Figure EX1.6	Google Earth horizontal distance measurement	See example Figure 16.9 (Image Source – Screen capture must include Google logo and third-party data providers)
Table EX1.1	Include elevation change (field measurement) and gradient calculations in %, degrees, and m/km.	See example Table 16.1

EX2: Create a Slope Profile of a Ski Run at a Ski Hill in British Columbia

Step 1: Choose a Ski Run

Open Google My Maps (<https://www.google.com/maps/d/u/0/>). Click **Create a new map**. Using the search function on the left of your screen, visit a ski hill (resort) in British Columbia. The BC Ski Map (<https://www.hellobc.com/things-to-do/ski-snowboard/bc-ski-map/>) contains more information about BC ski resorts. Zoom into the ski hill until all the lifts and runs are visible on the map. Select one ski run to use in this exercise.

It is recommended that you select a ski run below treeline which is easily traceable on satellite imagery. Ski runs should be longer in length, as short ski runs have few slope breaks. The ski runs at some smaller ski resorts may not be available on Google My Maps.

Step 2: Outline the Ski Run Using Google My Maps (Figure EX2.1)

Select **Add layer** and draw a thick yellow line over the ski run selected (see example Figure 16.10). **Include a screen capture of the run with the name visible in this exercise.** **Add marker** adjacent to the bottom of the ski run and record the latitude and longitude of this location in decimal degrees. **Share the Layer** and copy the link to include in the Figure EX2.1 caption. Your caption should also include a description including the ski hill name and coordinates.

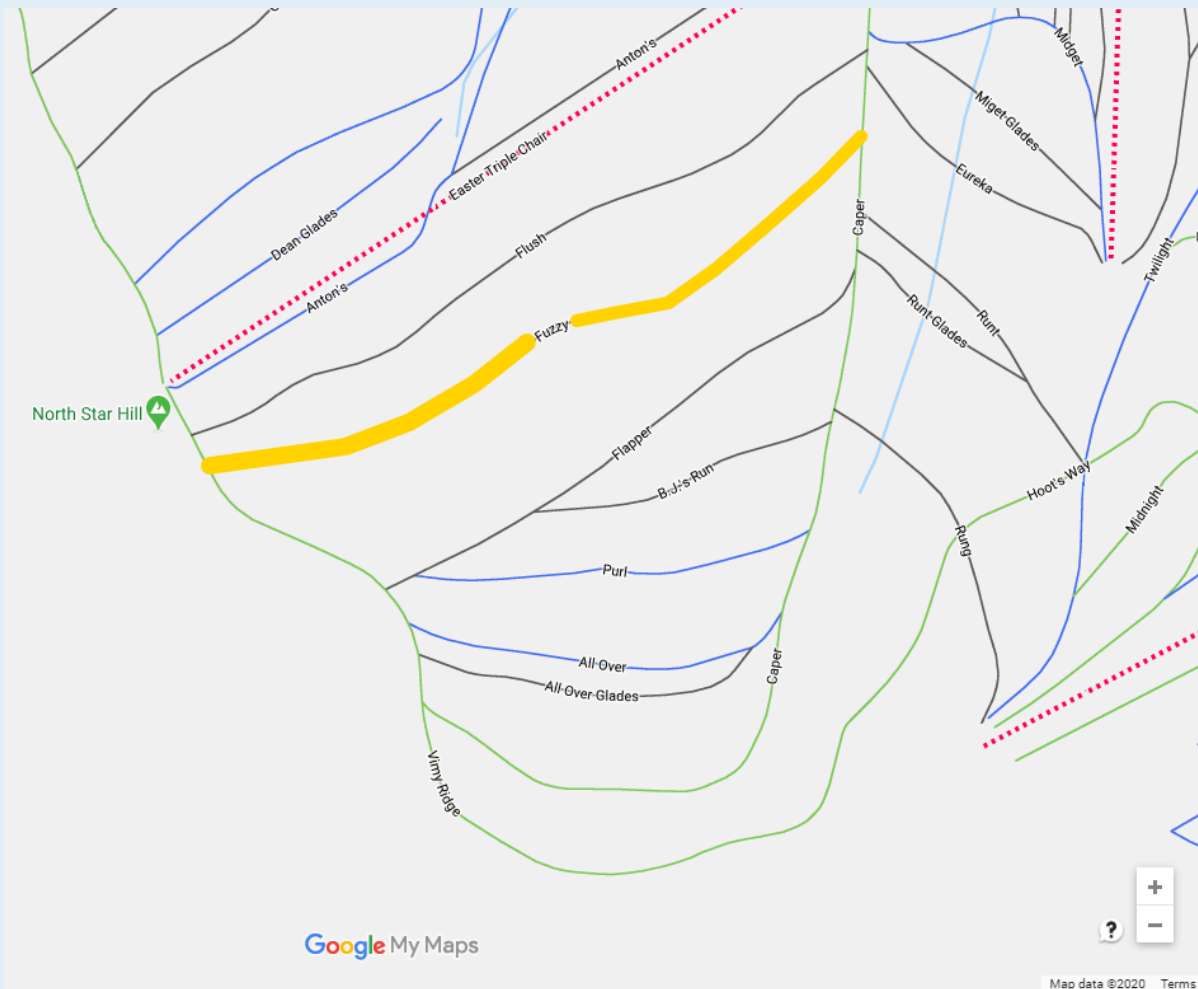


Figure 16.10. Example Figure EX2.1. Google My Maps screenshot of black diamond ski run named Fuzzy located at 49.68 N, 116.04 W at the Kimberley Alpine Resort (<include shareable link here>). The ski run is indicated by a thick yellow line. Source: K. Burles, adapted from Google My Maps (accessed June 22nd, 2020). Used in accordance with Google My Maps terms and conditions.

Step 3: Draw and Describe the Profile of the Ski Run Using iMapBC (Figure EX2.2)

Open iMapBC (<https://www2.gov.bc.ca/gov/content/data/geographic-data-services/web-based-mapping/imapbc>) and launch application (**Launch iMapBC**). Select the option that does not require a username. Change the base map from **Roads** to **Imagery**. The icon is located in the bottom-left of the screen. The ski hill lifts and runs are not drawn in iMapBC, but they are visible as clear-cut areas in the imagery.

Find your ski run. Using the **Lat/Long** function in the tool bar, zoom to the run. To input Lat/Long, convert the units from decimal degrees to degrees, minutes, and seconds. Use the National Geodetic Survey Coordinate Conversion and Transformation Tool (<https://www.ngs.noaa.gov/NCAT/>) to convert, or consult the pre-reading Lab 14 Degree Conversions for instructions on how to do this by hand. Input the Lat/Long in degrees, minutes, and seconds to zoom into the ski run in iMapBC.

Add Provincial Layers on the **Go to Data Sources** tab. Search layer catalog for **Contours – (1:20,000) (Base Maps – Contours – Contours – (1:20,000))**.

Create Figure EX2.2 for your report by drawing the ski run using the tools on the **Sketch** tab. Using the **Edit** tool, change the **Styles** of the line to change the colour and pattern of the line. Using the **Identify** tool on the **Home** tab, find the maximum and minimum elevation of the ski run. Using the **Distance** tool on the **Sketch**

tab, measure the length of the ski run. Add **Text** to the map on the **Sketch** tab, including the name of the run, the run length (e.g., Run = 832.3 m), and the maximum and minimum elevation (see example Figure 16.11). Take a screenshot of the image.



Figure 16.11. Example Figure EX2.2. iMapBC screen capture of ski run named Fuzzy at Kimberley Alpine Resort. The ski run is approximately 832.3 m in length and drops 300 m in elevation. The top and bottom of the ski run are located at 1900 m and 1600 m, respectively. Source: K. Burles, adapted from iMapBC (accessed June 22, 2020). iMapBC content: Copyright Province of British Columbia. All rights reserved. Reproduced with permission of the Province of British Columbia.

Step 4: Describe the Natural Breaks in Slope for the Ski Run (Figure EX2.3 and Table EX2.1)

By inspecting changes in the spacing of contour lines along the path of the run, divide the ski run into 4 segments at natural breaks in slope. Breaks in slope indicate a change in physical continuity in the slope profile. Segments of your ski run may be steeper (more linear distance between contour lines closer together) than other sections.

Position your breaks in slope where your path (the ski run) crosses a contour line. Measure the horizontal distance between each slope break segment and record the elevation. This will be Figure EX2.3 in your report. Figure 16.12 is an example outlining four slope break segments selected for the Fuzzy ski run.

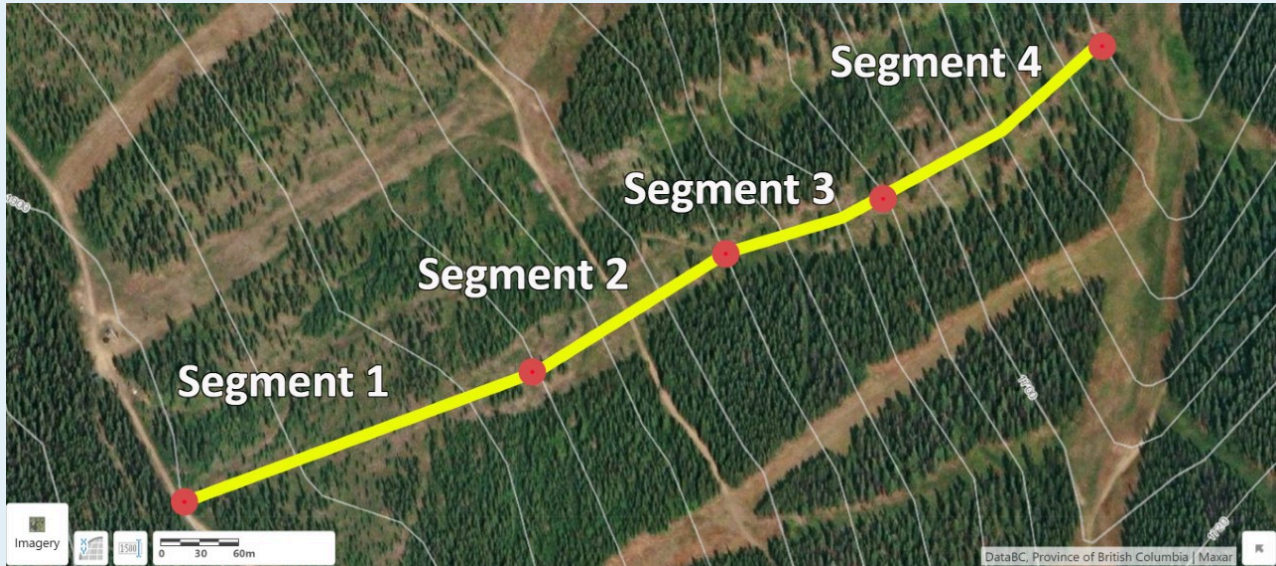


Figure 16.12. Example Figure EX2.3. Four natural slope break segments along the ski run Fuzzy at Kimberley Alpine Resort. The circles indicate the locations of the breaks in slope. Source: K. Burles, adapted from iMapBC (accessed June 22, 2020). iMapBC content: Copyright Province of British Columbia. All rights reserved. Reproduced with permission of the Province of British Columbia.

Create Table EX2.1 in your report to include the measurements you collected. An example is provided as Table 16.3.

Table 16.3. Example of Table EX2.1. Data Collected for Four Natural Slope Breaks Along the Ski Run Fuzzy at Kimberley Alpine Resort

Break in Slope Segments	Ski Run Distance for each break in slope segment (m)	Cumulative Ski Run Length (m)	Elevation Change for each break in slope segment (m)	Elevation at each break in slope (m)
Top of Ski Run (Segment 1)	–	0	–	1900
Bottom of segment 1	242.5	242.5	40	1860
Bottom of segment 2	237.2	479.7	80	1780
Bottom of segment 3	139.3	619	60	1720
Bottom of segment 4	213.3	832.3	120	1600
Total	832.3	–	300	–

Step 5: Create a Profile in Microsoft Excel (Figure EX2.4)

Open Microsoft Excel and enter the data in columns similar to Table EX2.1 (Table 16.3). Figure EX2.4 in your report will be a profile of the slope using a Scatter (x,y) Chart (see example Figure 16.13, Example

Figure 16.13 [Excel] (<https://pressbooks.bccampus.ca/geoglabmanualv2/wp-content/uploads/sites/1340/2021/03/EX2.4.-Profile-of-the-ski-run-Fuzzy-at-Kimberley-Alpine-Resort.xlsx>).

Adjust the maximum and minimum values displayed on the ski run elevation axis (y) to optimize the range of elevation in the profile. For example, the y axis in Figure 16.13 ranges from 1550 m to 1950 m. Microsoft Excel will default the axis to start at 0 m.

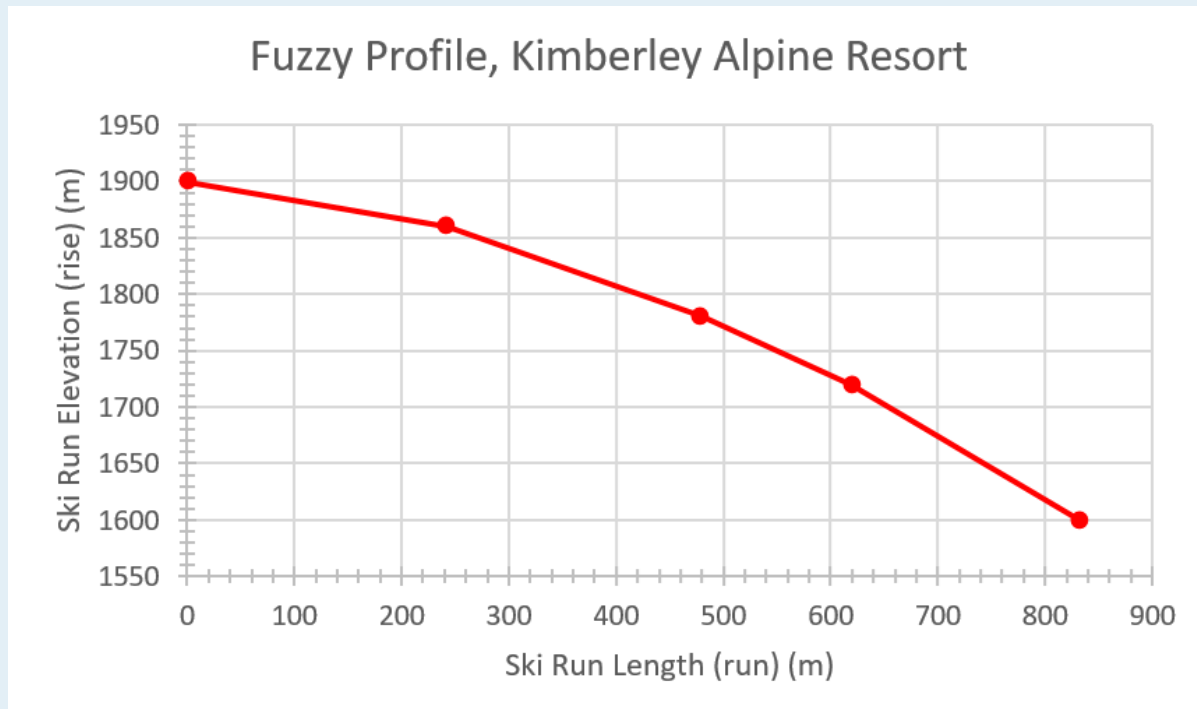


Figure 16.13. Example Figure EX 2.4 Profile of the ski run Fuzzy at Kimberley Alpine Resort. The elevation of the ski run decreases from 1900 m at the top to 1600 m at the bottom. Source: K. Burles, CC BY-NC-SA 4.0.

Step 6: Calculate Gradient Using Microsoft Excel

Calculate the slope gradient in Excel using the three calculations provided in Calculating Slope Gradient. Calculating gradient in degrees in Excel requires the use of the =ATAN function. The complete Excel expression is =(ATAN(rise/run)*(180/PI())). ATAN is an abbreviation for arctan, which is denoted \tan^{-1} . PI() is the notation for π in Excel.

Calculate the **average** gradient for each segment and include in Table EX2.2. An example is provided as Table 16.4.

Table 16.4. Example Table EX2.2. Gradient Calculations for the Ski Run Fuzzy at Kimberley Alpine Resort

Slope Segment	Gradient (%)	Gradient (°)	Gradient (m/km)
1	16.5	9.4	165.0
2	33.7	18.6	337.3
3	43.1	23.3	430.7
4	56.3	29.4	562.6
Average	37.4	20.2	373.9

Step 7: Assemble EX2 Component of Your Lab Report

Open the Word document created in EX1. Add EX2 and include Figures EX2.1 to EX2.4 and Tables EX2.1 and EX2.2 with detailed captions for each. Table 16.5 provides a checklist.

Table 16.5. List of Figures and Tables from EX2 to Include in Your Lab Report. Figure descriptions and example figures included. Use this table as a checklist to make sure you have all of the necessary elements in your report.

Item	Description	Caption (Attribution)
Figure EX2.1	Google My Maps screen capture of the ski run.	See example Figure 16.10 (Image Source – Google My Maps Attribution).
Figure EX2.2	iMapBC screen capture of the ski run including the name of the run, 20 m contour lines, maximum and minimum elevations, and run length.	See example Figure 16.11 (Image Source – iMapBC Attribution).
Figure EX2.3	iMapBC screen capture of the 4 natural slope breaks you used for your profile.	See example Figure 16.12 (Image Source – iMapBC Attribution).
Table EX2.1	Data collected for the 4 natural slope breaks you used for your profile.	See example Table 16.3.
Figure EX2.4	Profile of your ski run created in Microsoft Excel.	See example Figure 16.13.
Table EX2.2	Gradient calculations completed in Microsoft Excel for your ski run, including average slope.	See example Table 16.4.

Reflection Questions

Please take 15 minutes to answer the following questions using the experiences gained in completing this lab and from this course in general. Limit your answers to a maximum of 150 words.

EX1

1. If you were to do this assignment again, what would you do differently? Why? How would this improve your result? Breakdown your reflection into three short paragraphs, including preparing for the field, methods in the field, and your office work after the field.
2. Approximately, how precise would you estimate your vertical distance measurements to be, and how could you test their precision? Please give your estimates in terms of numerical values over a distance of 25 m, for example, ± 4 cm over 25 m.

EX2

3. How did your gradient measurement in the field from Exercise 1 compare to your ski run measurement? Would your gradient measurement from the field be steep enough to be an interesting ski run? Explain your answer.

Create a new part of your lab assignment titled **Reflection Questions** and type in your answers.

Report Submission

Once all exercises are complete, save the assignment as a PDF and submit as directed by your instructor. The PDF submission should be saved in **Layout – Orientation – Landscape** with images taking up at least 75% of the area of the page.

Worksheets

Back to Lab Exercises

Field Notes Template

- Lab 16 Field Notes Template [Word] (<https://pressbooks.bccampus.ca/geoglabmanualv2/wp-content/uploads/sites/1340/2020/07/Lab-16-Field-Notes-Template.docx>)
- Lab 16 Field Notes Template [ODT] (<https://pressbooks.bccampus.ca/geoglabmanualv2/wp-content/uploads/sites/1340/2020/07/Lab-16-Field-Notes-Template.odt>)
- Lab 16 Field Notes Template [PDF] (<https://pressbooks.bccampus.ca/geoglabmanualv2/wp-content/uploads/sites/1340/2020/07/Lab-16-Field-Notes-Template.pdf>)

Supporting Material

Appendix A: How to Build a Level

Back to Lab Exercises

This appendix describes two options for building a level. Choose the one that works for you:

1. Using an app on your cell phone;
2. Using a protractor template and craft supplies.

Option 1: Building a level using an app on your cell phone

Materials:

- Smart phone (recent model with accelerometer)
- Levelling app

- iOS devices can use the Measure app installed by default on your phone. Just press **level** (bottom of screen).
- Android phone users may want to try AR Measure (https://play.google.com/store/apps/details?id=com.peace.ArMeasure&hl=en_CA&gl=US).
- An 8.5”x11” piece of scrap paper rolled into a tube approximately the diameter of a straw
- Tape

Instructions:

Tape the paper tube along the long edge of your smartphone, while making sure that buttons do not get in the way of the tube being absolutely parallel with the long edge of your phone.

Using your paper tube, sight along the long edge of your phone as in Figure 16.14.



Figure 16.14. Photograph of rolled paper being used as a sighting tube by affixing it with tape to a cell phone. Note that the screen indicates that a reading of 0 degrees has been reached. Source: C. Huscroft, CC BY-NC-SA 4.0.

Option 2: Constructing your own level

Materials:

- Cardboard
- Protractor template (see Appendix B)
- 50 cm of thin string or sewing thread
- Stapler or tape
- A weight (such as a bag of coins)
- Scissors
- Paper glue
- Tape
- An 8.5”x11” piece of scrap paper rolled to the diameter of a straw and taped

Instructions:

1. Print out and glue the protractor template (see Appendix B) to a piece of cardboard.
2. Cut along out the template while glued to the cardboard.
3. Attach the weight to the end of the string.
4. Knot the other end of the string.
5. Staple or tape (must be strong) the knotted end of the string to the centre of the protractor.
6. Tape the rolled piece of paper along the straight edge of the protractor.
7. Level by sighting through the paper tube until the weighted string aligns with the 90° line as in Figure 16.15.



Figure 16.15. Photograph of a level constructed with the protractor template in Appendix B, cardboard, a string with a weight, and rolled paper being used as a sighting tube. Source: C. Huscroft, CC BY-NC-SA 4.0.

Appendix B. Protractor Template

Click the Figure 16.16 below to download.

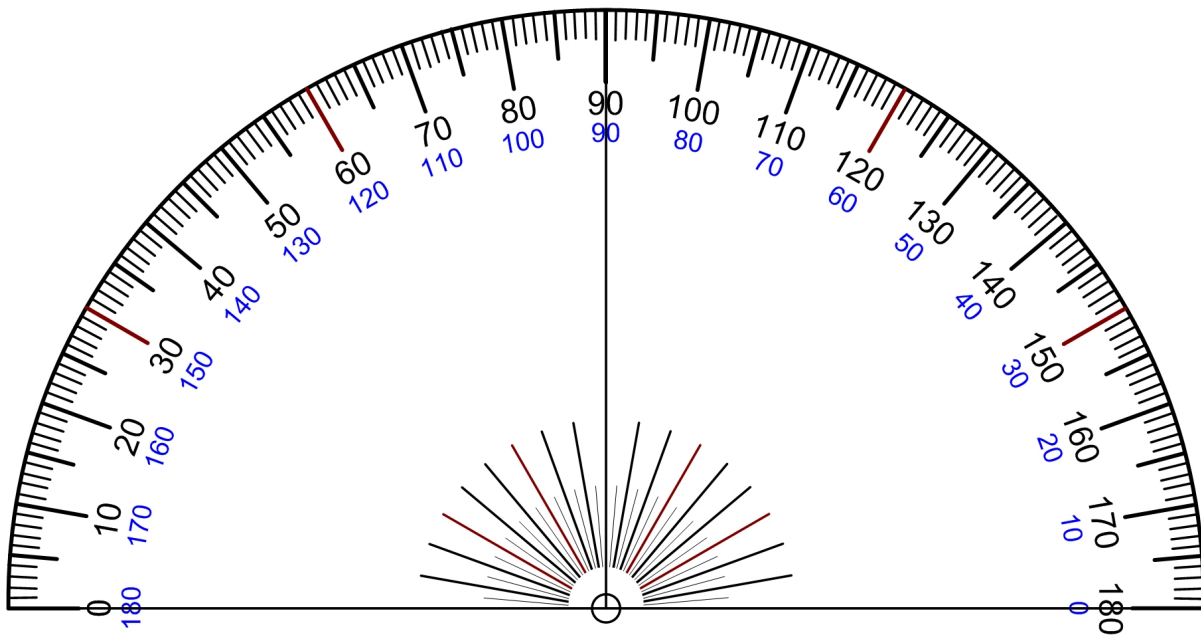


Figure 16.16. Printable protractor. Source: Scientif38 (2010) [JPG]. (https://en.wikipedia.org/wiki/File:Protractor_Rapporteur_Degree_V1.jpg) Public Domain.

References

Mulu, Y. & Derib, S.(2019).Positional accuracy evaluation of Google Earth in Addis Ababa, Ethiopia. *Artificial Satellites*, 54(2), 43-56. <https://doi.org/10.2478/arsa-2019-0005>

Lab 17: BC's Geology and Geologic Structures

Stuart MacKinnon; Fes de Scally; and Todd Redding

Geomorphology is the scientific study of the characteristics and origins of landforms. Landforms arise through the interplay between **endogenic** processes fueled by Earth's internal energy and **exogenic** processes ultimately fueled by the Sun. Endogenic processes tend to be responsible for the rock types and geological structures found in any particular area. Where geological structure dominates the surface landforms, they are called **structural landforms** and are the main focus of this lab.

This lab will provide experience in identifying and analyzing rock samples, identifying tectonic plate boundaries, interpreting geologic maps and cross-sections, and interpreting British Columbia's (BCs) geologic history and rocks from the various geologic belts that span the province.

Learning Objectives

After completion of this lab, you will be able to

- Distinguish between the three major classes of rocks.
- Understand the basic terminology relating to geological structures.
- Identify different types of tectonic plate boundaries.
- Interpret geological maps and cross sections.
- Analyze rocks from across the province of British Columbia, and predict which geologic belt the rock samples were obtained from.

Pre-Readings

Classification of Rocks: Igneous, Sedimentary and Metamorphic

Rocks can be classified into three main categories: igneous, sedimentary, and metamorphic.

Igneous Rocks

Igneous rocks form from the cooling and crystallization of **magma**. Igneous rocks are divided depending on the environment in which the magma cooled:

- **Intrusive igneous** or **plutonic** (named after Pluto, the god of the underworld in Roman mythology) rocks form from magma that cooled deep underground. Because the magma in

this case cools very slowly, intrusive igneous rocks usually contain relatively large mineral crystals. Common examples include granite, granodiorite, diorite and gabbro.

- **Extrusive igneous** or **volcanic** rocks form from magma in volcanic eruptions. Magma is called **lava** once it reaches Earth's surface. Because in this case the magma cools quickly on Earth's surface, the mineral crystals in the rock are either very small or non-existent. In situations where the lava cools very quickly, a volcanic glass called obsidian is produced. Common examples of extrusive igneous rock include basalt, dacite, andesite and rhyolite.

The precise type of intrusive or extrusive rock that is produced from cooling magma is determined by the magma's chemical composition, especially the abundance of **silica** (SiO_2). The silica content plays an important role in the physical characteristics of an igneous rock, including its resistance to weathering and erosion. It also plays an important role in the explosiveness of volcanic eruptions, because magma with a higher silica content is **stickier** and therefore more likely to produce an explosive eruption.

Sedimentary Rocks

Sedimentary rocks are formed by the **lithification** (compaction, cementation and hardening) of weathering and erosion products which have accumulated in a fluvial, marine or lacustrine environment over long periods of time. These products can be of two basic types, which provides us with a sub-classification of sedimentary rocks:

- **Clastic** sedimentary rocks are made from ground-down rock as well as other surviving minerals. Common examples include sandstone, conglomerate, siltstone or mudstone, and shale. Clastic sedimentary rocks exhibit a huge variation in their resistance to weathering and erosion depending on the degree of lithification of the clastic sediments they are composed of.
- **Carbonate** or **chemical** sedimentary rocks are made from the precipitation of minerals, primarily calcium carbonate, dissolved in water. Common examples are limestone (CaCO_3) and dolomite ($\text{CaMg}(\text{CO}_3)_2$).

Metamorphic Rocks

Metamorphic rocks are formed by the alteration or partial melting of a sedimentary, igneous or pre-existing metamorphic rock by heat and pressure beneath Earth's surface. Common examples include gneiss, marble, slate, schist and quartzite.

The specific type of metamorphic rock in question is largely a function of the original (or **parent** rock). For example, shale (a sedimentary rock) typically metamorphoses into slate, and granite (an intrusive igneous rock) typically metamorphoses into gneiss.

The type of metamorphic rock also depends on the degree of cooking that has occurred during the process of metamorphism. **Foliated rocks** result when the constituent minerals in the parent rock have been realigned into planar surfaces during metamorphism. **Non-foliated rocks** do not develop these planar fabrics.

Some metamorphic rocks can be more compact compared to their parent rock. Quartzite, for example,

is much more resistant to weathering and erosion than its parent rock sandstone. In other cases, metamorphism creates planes of weakness within the rock, such as the foliation in gneiss.

Tectonic Plate Boundaries

The theory of plate tectonics provides the model that underlies our understanding of modern geology and the interactions between oceans and continents. Plate tectonics explains why the highest and lowest points on Earth occur where they do. Plate tectonics also explains why and where we can observe highly deformed rocks at or near the surface. The deformation is seen in the form of geologic features such as **folds** and **faults**.

The type of plate boundary determines the types of deformation that may occur. **Transform**, or **strike-slip** plate boundaries occur when two plates move along each other in a predominately horizontal motion (scenario *a* in Figure 17.1). **Divergent** plate boundaries occur when two plates move away from each other (scenario *b*). **Convergent** plate boundaries occur when two plates move toward each other, or collide together (scenarios *c* and *d*).

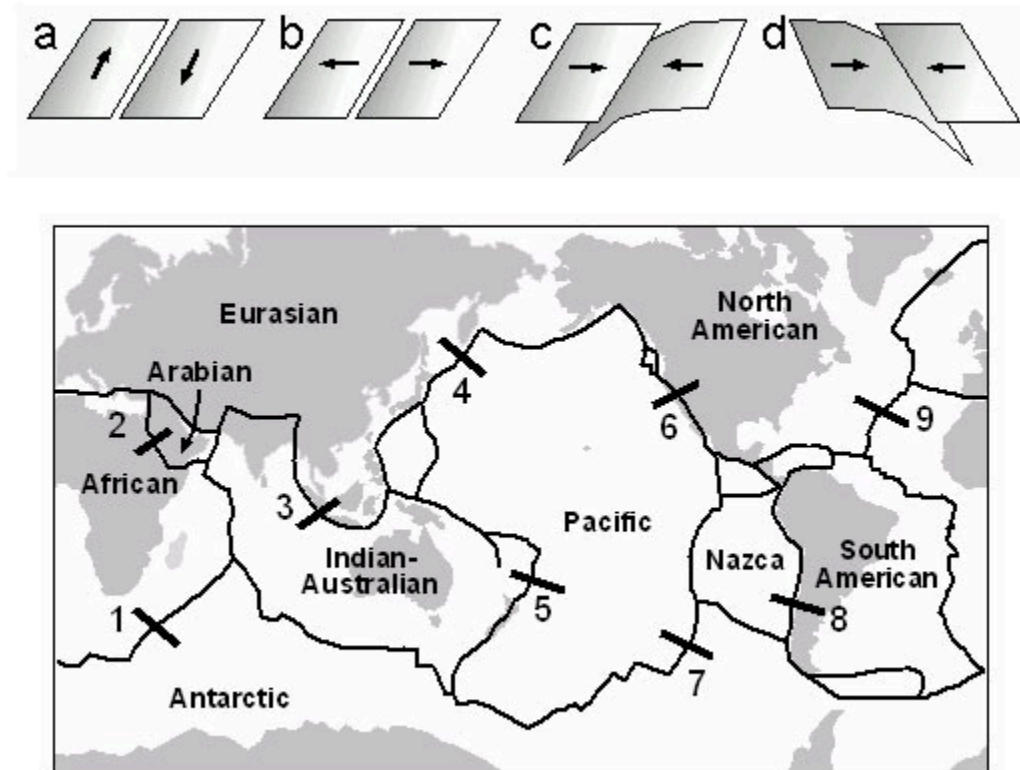


Figure 17.1. Top: Schematic illustration of the main types of plate interactions: a) transform boundary, b) divergent boundary, c) and d) convergent boundaries. Bottom: Map of the main global tectonic plate boundaries. Source: D. McDonnell (<https://serc.carleton.edu/details/images/2200.html>), CC BY-NC-SA 4.0.

Geologic Structures

Geological structure can be defined as the arrangement and attitude of rocks in Earth's **lithosphere**.

Structure results from **tectonism**, the deformation of Earth's crust by endogenic forces. Tectonism includes both **diastrophism**, large-scale deformations of the crust producing mountain ranges, ocean basins, etc., and **volcanism**, the creation of crustal material on a more localized scale through volcanic activity. Both sets of processes are a result of the mechanism of plate tectonics.

Geological structures can be relatively simple if tectonic forces have not deformed the crust to any great degree. Examples include the horizontal beds of young sedimentary rocks which underlie much of the Prairie provinces of Canada. On the other hand, where deformation has been substantial, the resulting geological structure can be extremely complicated. Examples include the intensely deformed sedimentary and metamorphic rocks of many of BC's mountain ranges or the Himalaya of South Asia.

Tectonism can produce a wide variety of geological structures including **folds** (flexures or bends in the crustal rocks due to compressional forces), and **faults** (brittle ruptures or fractures in the crustal rocks). Note that folding rarely involves rupturing of the rock, but faulting does.

Folding and faulting impose two types of attitudes on the rock. **Dip** is the angle (measured in degrees) which the rock **strata** (layers, fault or any planar feature) make with a horizontal plane, measured in a direction perpendicular to the **strike** of the rock strata (Figure 17.2). Strike is the intersection between the plane in question and the horizontal plane. It is commonly expressed using the cardinal directions of the compass or as a full-circle azimuth.

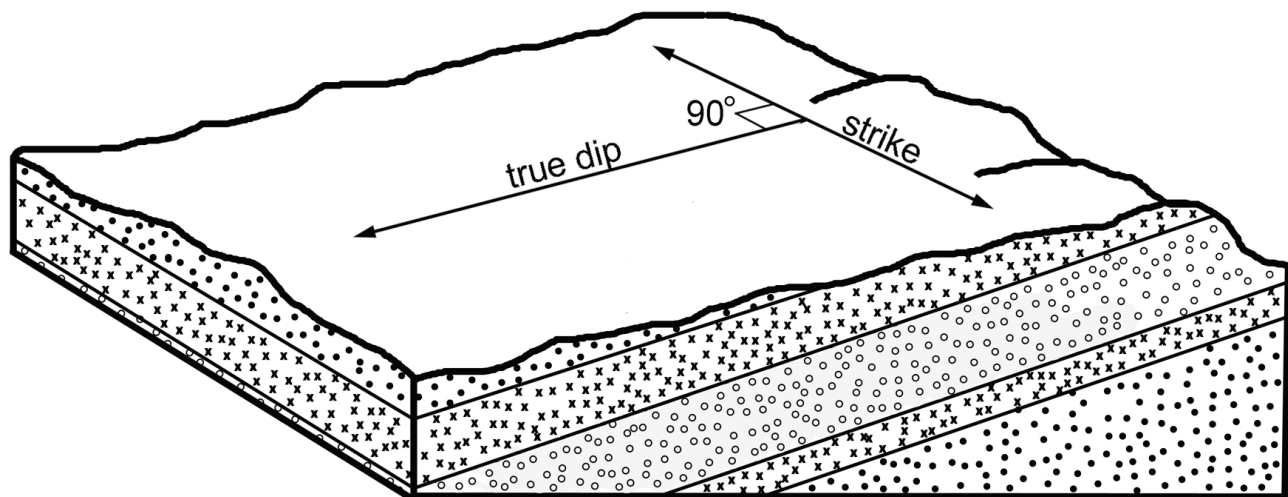


Figure 17.2. Strike and dip of geological strata. Note that apparent dip is any dip angle not measured perpendicular to the strike; it underestimates the true dip. Source: F. de Scally, CC BY-NC-SA 4.0.

Geologic History of British Columbia

The geologic history of BC dates back to a time when there was actually no BC west of today's Rocky Mountains. The western edge of the ancestral North American continent, composed of the ancient plutonic rocks of the North American **craton** (continental core), was situated roughly where Calgary and Dawson Creek are located today (Figure 17.3). West of this ancient shoreline, the submarine **continental shelf** extended roughly to where the town of Golden is situated today (just east of Revelstoke in Figure 17.3).

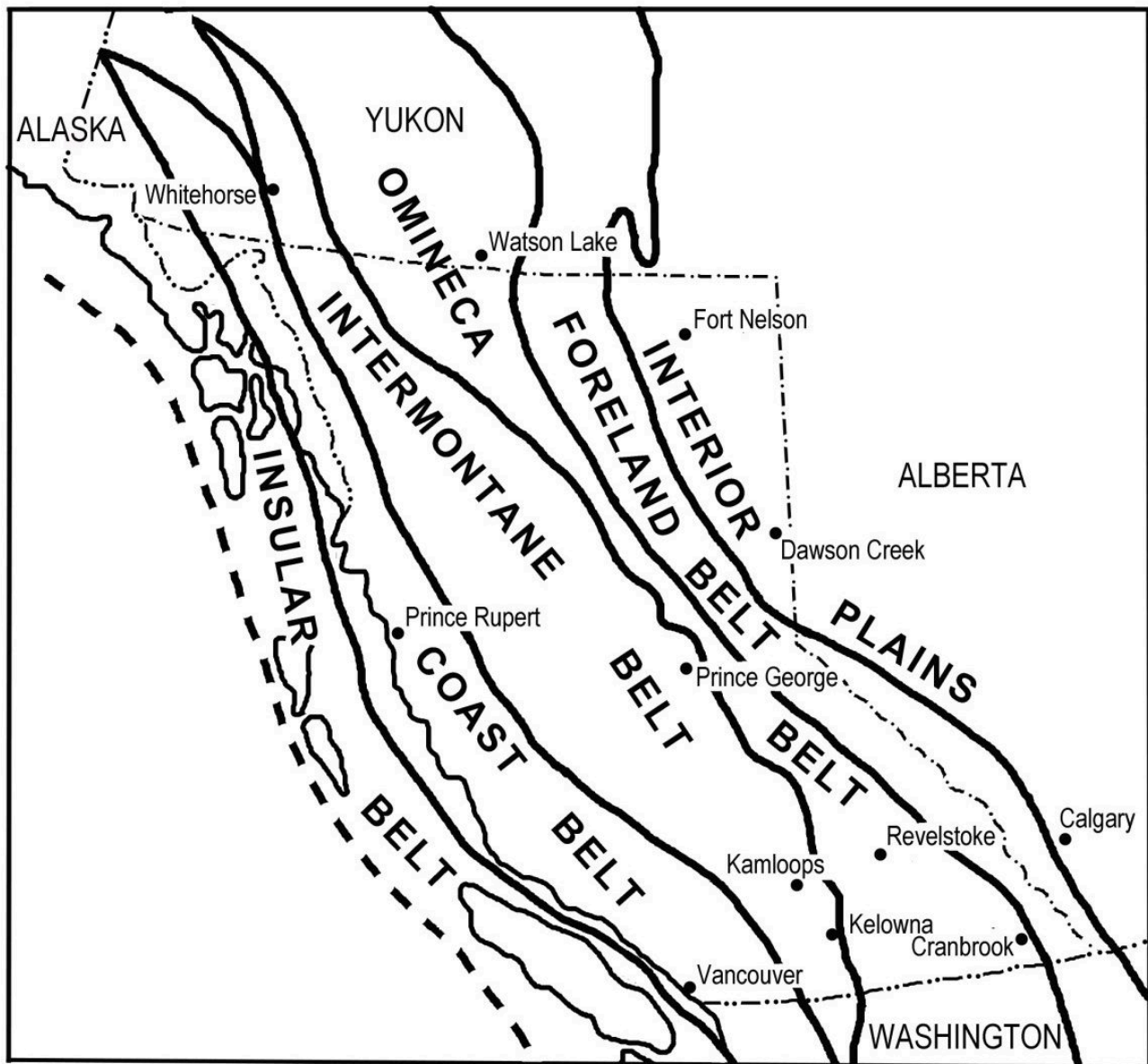


Figure 17.3. Geological belts of British Columbia, which correspond roughly to the major physiographic regions of the province. Source: F. de Scally, CC BY-NC-SA 4.0. [Image description]

The following sections describe important intervals in BC's geologic history. Some of this information is derived from *British Columbia: A Natural History* (Cannings and Cannings, 2004). Note that **Ga** = **billion years**, **Ma** = **million years**, a **terrane** is a fragment of crust formed on, or broken off of, a tectonic plate and added to crust on a different plate, and a **superterrane** is a group of related terranes.

1.7 Ga to 180 Ma

Over an immense time period of about 1.5 billion years, sediment eroded from the ancient North American craton is deposited in a **miogeocline** (a part of the submarine continental shelf along a tectonically quiescent continental margin where sediment deposition occurs) just offshore of the western margin of ancestral North America.

Although this continental margin formed a part of different **supercontinents** at various times over this period, including **Rodinia** and **Pangaea**, it was tectonically quiescent. This allowed uninterrupted sediment deposition in the miogeocline. Both clastic sediments (muds and sands) and carbonate sediments (from coralline organisms) were deposited, which has important implications for the formation of the Foreland Belt much later.

750-300 Ma

The supercontinent Rodinia broke up and another supercontinent Pangaea began to assemble. The wedge of sediment in the miogeocline offshore of ancestral North America continued to build and was eventually lithified into sedimentary rock. This included the burial of marine organisms around 530 Ma which today form the world-famous Burgess Shale fossil beds in Yoho National Park of BC.

245 Ma

The supercontinent Pangaea began to break up. Earth's tectonic plates began their slow movement into their modern configuration.

200 Ma

Up to 2,000 km away in the ancestral Pacific Ocean, at an old plate boundary, the **Intermontane superterrane** began to assemble when the Stikinia and Quesnellia **terranes (volcanic island arcs)** were amalgamated with the sea floor sediments of the Cache Creek and Slide Mountain terranes. This produced a **mélange** (mix) of sea-floor sedimentary rocks and volcanic rocks.

180-150 Ma

A change in the direction of plate movement caused the ancestral North American continent to collide with the Intermontane superterrane. The tremendous heat and pressure of this slow-motion collision caused rocks of the miogeocline and the Intermontane superterrane to be metamorphosed at a **weld** to form the Omineca Belt. The metamorphic rocks of the Omineca Belt today form the Columbia, Cassiar, Monashee and Selkirk Mountains as well as the Quesnel and Shuswap Highlands of BC.

Following the collision, the Intermontane Belt to the west consisted mostly of the **mélange** rocks of this ancient superterrane, with occasional deeply buried and very old plutonic rocks protruding through these much younger rocks. Today, these protrusions form high peaks such as Big White Mountain near Kelowna. The shoreline of ancestral North America was located roughly at the western boundary of the Intermontane Belt by 150 Ma (Figure 17.3).

120 Ma

By 120 Ma, the sedimentary rocks of the former miogeocline had been pushed eastward and upward by the tremendous force of the Intermontane Superterrane's collision to form the eastern Rocky Mountains of the Foreland Belt. These forces not only produced significant folding of the rocks, but also **thrust faults** when layers of strong, resistant carbonate rock were broken and shoved eastward in thick **thrust sheets**. The force of the collision also created a deep topographic depression east of the newly formed

Rocky Mountains, which shortly began to fill with eroded sediment to eventually form weak clastic rocks such as shale and mudstone.

100-60 Ma

Another superterrane, the Insular superterrane, assembled earlier far offshore when the volcanic island arcs of the Wrangellia and Alexander terranes collided with the western edge of the Intermontane Belt. The *mélange* of sea floor sedimentary rocks and volcanic rocks in the resulting Insular Belt today makes up the mountains of Vancouver Island and Haida Gwaii.

Following this collision, the west coast of BC looked much like it does today. The heat of this collision also created the intrusive igneous (plutonic) rocks of the Coast Belt, which today make up the Coast and Cassiar Mountains and Okanagan Highlands of BC.

The force of this collision also continued to build the eastern Rocky Mountains in the Foreland Belt, with thrust faulting continuing to push rocks as much as 250 km eastward. For example, the rocks of Mount Rundle in Banff located near the eastern edge of the Foreland Belt were originally formed near where Revelstoke is situated today (Figure 17.3). During this thrust faulting, the weak shales and mudstones deposited after 120 Ma east of the ancestral Rocky Mountains were shoved in between layers of strong limestone to form the classic weak-strong-weak-strong layering in the geological structure of the Foreland Belt. Further east, the horizontal layers of weak post-120 Ma sedimentary rock in the Interior Plains belt (Figure 17.3) were unaffected by the force of the superterrane collisions, forming the modern flat Prairie landscape.

85 Ma

The motion of oceanic tectonic plates to the west of BC changed, and instead of moving northeastward toward the North American plate, the motion became more northerly. This stretched the continental crust and produced extensive **strike-slip faulting** in BC. The best example of this was the 750 km of lateral displacement along the northern section of the Rocky Mountain Trench (at the boundary between the Omineca and Foreland Belts in Figure 17.3). This stretching also created the parallel-to-the-coast orientation of BC's geologic belts (Figure 17.3) and the province's many mountain ranges.

60-50 Ma

A standstill in plate movement allowed the geologic belts thrust eastward by the superterrane collisions to slump back toward the west. This created roughly northwest-southeast oriented valleys in BC, including the southern portion of the Rocky Mountain Trench and the Okanagan Valley. This **relaxation** of the crust also allowed the deeply buried Monashee gneiss – at 2 Ga, the oldest rocks in BC – to be exposed in the Okanagan Valley.

55-36 Ma

Further relaxation of the crust allowed extensive volcanic lava flows to cover much of the BC Interior, especially in the Intermontane Belt. As a result, many of the original rocks of the Intermontane Belt were buried by basaltic lava flows. In general, volcanic eruptions in the Intermontane Belt produced

basaltic rocks of lower silica content, while more explosive eruptions of lava with higher silica content in the Coast Belt produced rhyolitic rocks and breccias.

40-5 Ma

A **non-orogenic period** brought mountain building to a halt, and allowed erosion by streams and rivers to begin to shape the modern drainage pattern of BC. An **erosion surface** of gentle hills formed west of the Foreland Belt, and by 10 Ma the mountains of the Coast Belt were so low that there was no longer a climatic **rain shadow** on the leeward (east) side.

21-5 Ma

Multiple episodes of volcanic activity occurred in the Intermontane Belt and in the Coast Belt.

5-1 Ma

A final **orogenic period** occurred when the **subduction zone** under small tectonic plates west of the North American coastline steepened, resulting in **reheating** of the crust in the Coast Belt. This reheating uplifted the 40-5 Ma erosion surface by about 2000 m, resulting in the modern mountains of the Coast Belt. The reheating also produced the volcanoes of today's Cascade Volcanic Arc, stretching from the southern Coast Mountains of BC to northern California. There was also uplifting and warping of much of the plateau surface in the Intermontane Belt. Today, the resulting undulating plateau surface is clearly visible from Pennask Summit along Highway 97C (the **Okanagan Connector**) west of Kelowna.

2.6-0.01 Ma

Glaciations during the Pleistocene epoch eroded the modern landscape pattern of BC, including the rugged mountain ranges of the Foreland, Omineca, Coast and Insular Belts.

Lab Exercises

In this lab you will

- Classify rocks into the three major classes.
- Identify and locate different plate motions at tectonic boundaries.
- Interpret structural features from a geologic cross section.
- Match rock types to geologic history.

You will need an internet connection to download maps. EX2 and EX3 may be easier if you are able to print the maps. It is assumed that you have successfully completed Lab 12. It is also assumed that you can convert between metres and feet. The exercises should take you 1½ to 3 hours to complete.

EX1: Classification of Rocks

1. Classify each of samples 1A-1F in the slide deck below (Figure 17.4a–f) as igneous, sedimentary, or metamorphic, and provide a one-sentence explanation of the reasoning for each of your choices. If the slide deck does not display below, click here for Figure 17.4 (https://pressbooks.bccampus.ca/geoglabmanualv2/wp-admin/admin-ajax.php?action=h5p_embed&id=19).



Figure 17.4a



Figure 17.4b



Figure 17.4c



Figure 17.4d



Figure 17.4e

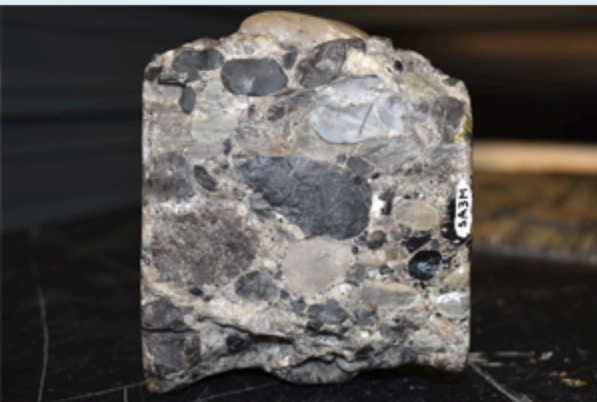


Figure 17.4f

Figure 17.4. Igneous, sedimentary or metamorphic slide deck.

2. Classify igneous rock samples 2A-2D in the slide deck below (Figure 17.5a–d) as **intrusive** (also known as plutonic) or **extrusive** (also known as volcanic), and provide a one-sentence explanation detailing your logic for each choice you made. If the slide deck does not display below, click here for Figure 17.5 (https://pressbooks.bccampus.ca/geoglabmanualv2/wp-admin/admin-ajax.php?action=h5p_embed&id=20).

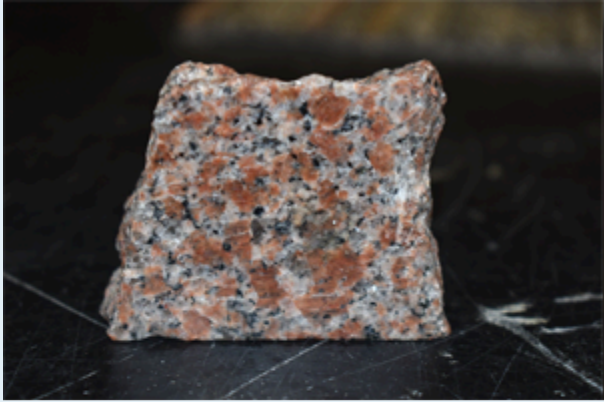


Figure 17.5a



Figure 17.5b



Figure 17.5c



Figure 17.5d

Figure 17.5. Igneous slide deck.

3. Classify sedimentary rock samples 3A-3D in the slide deck below (Figure 17.6a–d) as **clastic** or **carbonate or chemical**, and provide a one-sentence explanation detailing your logic for each choice you made. If the slide deck does not display below, click here for Figure 17.6 (https://pressbooks.bccampus.ca/geoglabmanualv2/wp-admin/admin-ajax.php?action=h5p_embed&id=21).



Figure 17.6a



Figure 17.6b



Figure 17.6c



Figure 17.6d

Figure 17.6. Sedimentary slide deck.

4. Classify metamorphic rock samples 4A-4D in the slide deck below (Figure 17.7a-d) as **foliated** or **non-foliated**, and provide a one-sentence explanation detailing your logic for each choice you made. If the slide deck does not display below, click here for Figure 17.7 (https://pressbooks.bccampus.ca/geoglabmanualv2/wp-admin/admin-ajax.php?action=h5p_embed&id=22).



Figure 17.7a



Figure 17.7b



Figure 17.7c



Figure 17.7d

Figure 17.7. Metamorphic slide deck.

EX2: Plate Tectonic Boundaries

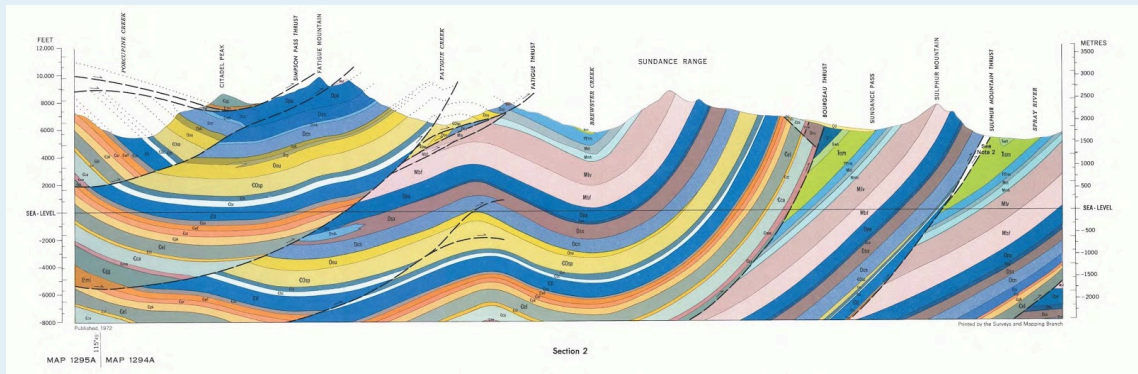
5. Figure 17.1 (bottom) is a map showing the major plate boundaries found on Earth. The schematic cross-sections a) to d) show four models of relative plate motions. Download and use the map Detailed Tectonic Plate Boundaries [PDF] (https://pressbooks.bccampus.ca/geoglabmanualv2/wp-content/uploads/sites/1340/2021/03/Detailed_Tectonic_Plate_Boundaries.pdf) to determine which of these cross-sections best represents the plate motion at each of the numbered locations (1-9) found on Figure 17.1. Explain your answers. the numbered locations are at the following tectonic plate boundaries:

1. African and Antarctic
2. African and Arabian
3. Indian-Australian and Eurasian
4. Pacific and Eurasian

5. Indian Australia and Pacific
 6. Pacific and North American
 7. Pacific and Antarctic
 8. Nazca and South American
 9. North American and African
6. At which of these numbered boundaries would you expect to find old rocks that have been folded and deformed? Explain your answer.
 7. At which of these numbered boundaries would you expect to find young undeformed rocks? Explain your answer.

EX3: Geological Structure Basics

- Figure 17.8 shows a geological cross-section of the area near Banff, Alberta, Canada, that was created by the Geological Survey of Canada (GSC). Download a PDF version of Figure 17.8 Banff East-Half Cross Section [PDF] (https://pressbooks.bccampus.ca/geoglabmanualv2/wp-content/uploads/sites/1340/2021/03/gscmap-a_1294A_e_1972_xs02_EastHalf.pdf) and the corresponding 1:50,000 Banff Geology map [PDF] (https://pressbooks.bccampus.ca/geoglabmanualv2/wp-content/uploads/sites/1340/2021/03/gscmap-a_1294a_e_1972_mn01.pdf) (legend is on the map) so that you can view the area in more detail.



(https://pressbooks.bccampus.ca/geoglabmanualv2/wp-content/uploads/sites/1032/2020/07/Figure_15.8.jpg)

Figure 17.8. Geological Survey of Canada: Banff East-Half Cross Section. Source: Geological Survey of Canada (<https://geoscan.nrcan.gc.ca/starweb/geoscan/servlet.starweb?path=geoscan/fulle.web&search1=R=108961>), Open Government License.

8. Match the structural features identified on the GSC Banff East-Half Cross Section and listed in Table 17.1 with the corresponding location name found on the 1:50,000 Banff Geology map.

Table 17.1. List of structural features to match with location names on Banff Geology map.

Structural Feature	Location Name on Banff Geology Map
a. Gently dipping strata	Brewster Creek
b. Eroded asymmetrical anticline	Fatigue Creek
c. Steeply dipping strata	Fatigue Mountain
d. Asymmetrical syncline overlain by recent glacial and fluvial deposits	Sulfur Mountain Thrust

9. Which location name has the oldest rocks at the surface? Explain your answer.
10. The **Qd** beds on the geological map are fundamentally different from all the other formations shown on the geologic cross section. In what way are they different?

EX4: Analysis of Rock Samples from British Columbia

11. Examine the eight rock samples in the slide deck below (Figure 17.9a–h), then name the geologic belt on Figure 17.3 from which each sample was obtained.



Figure 17.9a Granodiorite



Figure 17.9b Limestone



Figure 17.9c Volcanic Breccia



Figure 17.9d Gneiss, a high-grade metamorphic rock



Figure 17.9e Quartzite



Figure 17.9f Phyllite, a low- to medium-grade metamorphic rock



Figure 17.9g Greenschist, a low-grade metamorphic rock



Figure 17.9h Basalt

Figure 17.9. British Columbia rocks slide deck.

Provide a two-sentence rationale for your choice of geologic belt for each sample. In answering this question, use information on rock type supplied in BC's Geologic History, along with information from the internet regarding the rock names. If the slide deck does not display below, click here for Figure 17.9 (https://pressbooks.bccampus.ca/geoglabmanualv2/wp-admin/admin-ajax.php?action=h5p_embed&id=23).

Reflection Questions

1. BC is quite unique in that it has mountain ranges dominated by sedimentary rocks (e.g., the Rocky Mountains), mountain ranges dominated by metamorphic rocks (e.g., the Monashee Mountains) and mountain ranges dominated by igneous rocks (e.g., the Coast Mountains). Assume you have never visited any of these mountain ranges and write a short 2-3 sentence explanation about which one you think would be most geologically interesting to you, and why.
2. If you live in BC, which geologic belt do you live in, and what kinds of rocks are dominant in your area?
3. Did students from similar areas post similar looking rocks? Why or why not?
4. EX2 examined large global tectonic plate boundaries, but when you can look in more detail there is a lot more going on. Look closely at the western North American plate boundaries in the Detailed Tectonic Plate Boundaries [PDF] (https://pressbooks.bccampus.ca/geoglabmanualv2/wp-content/uploads/sites/1340/2021/03/Detailed_Tectonic_Plate_Boundaries.pdf) from EX2, and examine the boundaries that exist between the Pacific Plate, the Juan de Fuca Plate, and the North American Plate. Answer the following questions, and explain your thinking.
 - a. What will eventually happen to the Juan de Fuca plate?
 - b. Why are there volcanoes in the Cascade and Coast mountains?
 - c. If you could see 20 million years into the future, where would you have to look for land west of the San Andreas Fault?

References

Cannings, R., & Cannings, S. (2004). *British Columbia: A natural history*. Greystone Books.

Image Descriptions

Figure 17.3. Geological belts of British Columbia

map of the geological belts that can be found in the province of BC, and the bordering edges of the neighboring province (Alberta), territory (Yukon), and US States (Washington and Alaska). There are

six geologic belts that each run as approximately northwest to southeast bands that roughly following the physiographic regions of the province.

The geologic belts of BC from west to east are:

- The insular belt; which covers the islands of BC (including Vancouver Island and Haida Gwaii), and the southern tip of the Alaskan mainland coast.
- The coast belt; which covers the mainland coast of BC from Vancouver, through Prince Rupert, and up through the BC-Yukon border to the edge of the Yukon-Alaska border.
- The intermontane belt; which covers part of the interior region of BC from the Okanagan (including Kelowna), Thompson (including Kamloops), and Nicola valleys in the south, to Prince George in the middle of BC, up to Whitehorse in the Yukon. The intermontane belt is widest in the middle of the province, from Prince George on the east side extending westward.
- The omineca belt; which contains the Kootenays (including Cranbrook) in the south where this belt is wide, through the middle of the province where it is quite narrow, up to Watson Lake in the Yukon where the belt becomes wide again.
- The foreland belt; which contains the Rocky Mountains. For the southern half of the Rocky Mountain range, the province of BC is on the west side, and the province of Alberta is on the east side. Further north, the mountain range runs entirely through BC.
- The interior plains; which contains the city of Calgary, Alberta in the south, and Dawson Creek, BC and Fort Nelson, BC in the north.

[Return to Figure 17.3]

Lab 18: Volcanoes and Earthquakes

Chani Welch; Todd Redding; Stuart MacKinnon; and Fes de Scally

Vulcanicity (volcanism) and earthquakes (seismic activity) are common processes in tectonically active parts of the world. The most profound discovery in the earth sciences in the past century has been plate tectonics, which provides the mechanism with which to understand how continents move around the globe. For physical geographers, the greatest value of the theory of plate tectonics lies in its ability to explain the spatial distribution of volcanism, earthquakes, and other major landscape features such as mountain chains on Earth.

British Columbia is located in the Pacific Northwest, a tectonically active part of the world. As such, volcanoes and earthquakes have, and continue to, modify the landscape in which we live, affecting our daily lives.

Learning Objectives

After completion of this lab, you will be able to

- Understand the role of plate tectonics in determining (or controlling) the types and locations of volcanoes.
- Understand the role of plate tectonics in determining (or controlling) the types and locations of earthquakes.
- Understand the hazards associated with volcanoes and earthquakes.
- Be able to calculate rates of geologic movement.
- Be able to calculate return periods of geologic events.
- Use Google Earth (Web) to make geographical measurements.

Pre-Readings

Plate Boundaries, Volcanism and Earthquakes

Most volcanism and seismic (earthquake) activity on Earth occur along the boundaries of tectonic plates where they interact with adjacent plates. Interaction between adjacent plates at these boundaries can take three forms:

- **Divergence** where plates are moving away from each other, frequently by **seafloor spreading**;

- **Convergence** where plates are colliding with each other, the collision taking three different forms:
 - ocean – ocean plate collisions where the heavier colder plate slides under the lighter plate, producing **volcanic island arcs**;
 - **subduction zones** where a more dense oceanic plate is forced below a less dense continental plate, producing volcanic activity inland; and
 - continent – continent collisions where the collision causes intense folding, faulting and uplift; and
- **Transform (strike-slip) faulting** where the adjacent plates are sliding laterally past one another.

For further review, please refer to Lab 17.

Volcanoes

Volcanoes develop where magma reaches Earth's surface, which includes the following settings:

- Tectonic plate boundaries (convergent or divergent);
- Hot spots, where plumes of magma rise up from the mantle through the rigid lithosphere; and
- Rift zones located at great distance from any plate boundary.

The volcanoes of the **Cascade Volcanic Arc** in British Columbia (BC) and the western United States (US), for example, are created by **subduction** at the Cascadia Subduction Zone. The **hotspot volcanoes** of Hawai'i and the **flood basalts** of the Deccan Traps of west-central India are probably the best-known examples of volcanism associated with mantle plumes and rift zones, respectively. Both types are also found in BC. For example, the Anahim Volcanic Belt (Figure 18.1) provides evidence of a hotspot that has been active over the past 13 million years (Ma).

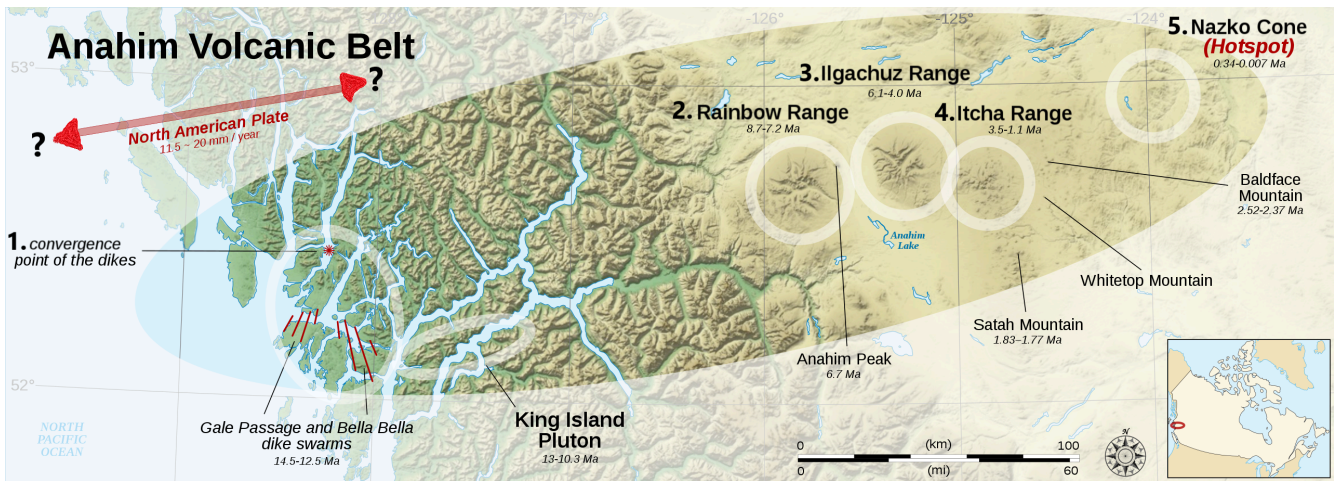


Figure 18.1. Location and features of the Anahim Volcanic Belt in British Columbia identified by white circles. From left to right: 1. dike swarm convergence point [Gale Passage and Bella Bella dike swarms (14.5-12.5 Ma)]; 2. Rainbow Range (8.7-7.2 Ma); 3. Ilgachuz Range (6.1-4.0 Ma); 4. Itcha Range (3.5-1.1 Ma); and 5. Nazko Cone (Hotspot) (0.34-0.007 Ma). The average rate of movement of the North American (tectonic) Plate is given as 11.5-20 mm/year. The direction is not specified. Source: C. Welch (https://commons.wikimedia.org/wiki/File:Anahim_Volcanic_Belt-en.svg) adapted from Sémhur (2007) CC BY-SA 4.0.

Volcanoes are composed of **extrusive** igneous rock, the type of which depends on the mechanism of formation. Volcanic landforms can be composed of solidified lava, ash and other material ejected from the volcano. Types of volcanoes are classified by size, material composition and geologic setting. The three types of volcanoes are described in Table 18.1.

Table 18.1. Types of volcanoes, size, geologic settings, rock type and properties.

Volcano Type	Size	Geologic Setting	Type of Rock	Silica Content and Viscosity
Shield	Enormous	Oceanic divergent boundaries; hot spots	Basalt	Low
Composite or Stratovolcano	Medium	Subducting convergent boundaries; continental divergent margins	Rhyolite & Andesite	Moderate to high
Cinder Cones	Very small	Hot spots; all divergent and convergent boundaries	Basalt	Low to high

Shield Volcanoes are the largest volcanoes and occur over hot spots (e.g. Hawai’i) or at divergent plate boundaries (e.g. Iceland). The magma that forms these volcanoes has a low silica content and viscosity, which results in oozing lava flows, and effusive eruptions with little ash. The lava flows rapidly over long distances before cooling, and forms rather flat volcanoes with gently-sloping sides.

Composite or Stratovolcanoes typically occur at convergent and subducting plate boundaries. The magma contains moderate to high quantities of silica, and is much more viscous; consequently, the magma is thicker and results in explosive eruptions with a mixture of lava, tephra, ash and pyroclastics. The volcanoes that result from the alternating layers of lava and ash are steep-sided cone-shaped mountains that are often topped by ice (e.g. Mt. Ranier in the USA), even when they are located in the tropics (e.g., Popocateptl in México).

Cinder Cones are small volcanoes that occur in a variety of volcanic settings, but typically in association with larger volcanoes. Because the geologic setting for cinder cones is variable, the magma that forms cinder cones is also variable, ranging from low to high silica content, and low to high viscosity. The combination of lava and ash that erupt explosively from these small volcanoes forms steep-sided but small cones.

Volcanic Hazards

Volcanic hazards to human activity are numerous, and some can persist for years, centuries, and even millennia following an eruption. The following is a brief description of these hazards.

The term **pyroclastics** comes from the Greek words **pyr (fire)** and **klastos (broken in pieces)**. It refers to any magma which is explosively erupted into the atmosphere and then cooled and solidified prior to hitting the ground. It ranges in size from large blocks of rock (volcanic bombs) to fine ash. **Tephra** is another term for pyroclastics.

Pyroclastic Falls

These occur when pyroclastic material (**pyroclastics**) rains out of an eruption column in the atmosphere. While coarse pyroclastic material such as **volcanic bombs**, **pumice** and **scoria** rarely land far from the erupting vent, finer material such as **lapilli** and **ash** can travel much further. Fine ash can travel hundreds to thousands of kilometres from its eruption source, and is therefore the most far reaching hazard during a volcanic eruption.

Pyroclastic Flows

When all or part of an eruption column thrown into the atmosphere collapses back on itself, or when a solidified dome of lava at the volcano's vent suddenly collapses, pyroclastics may flow rapidly down the slopes of an erupting volcano. In addition to often travelling at speeds of more than 200 km/h, pyroclastic flows are very hot (several hundred °C). This makes them one of the most destructive effects of volcanism. A **nuée ardente** (French for **glowing cloud**) is a particularly destructive type of pyroclastic flow consisting of a fast-moving mixture of pyroclastic material and glowing hot gases.

Lava Flows

Flows of molten lava occur when erupting lava is not immediately solidified and shattered into pyroclasts. The ability of lava to flow depends on its **viscosity**, which is largely a function of its silica content (Table 18.1). Lava flows rarely threaten human lives because the lava moves too slowly, but anything in their path is usually completely destroyed. The eruptions of Mount Kīlauea in Hawai'i in 2018 illustrate how extensive lava flows can be created during **effusive eruptions** of low-viscosity magma.

Debris Avalanches

Sudden and rapid avalanches of volcanic rock can occur when gravity acts on the steep slopes of composite volcanoes. Debris avalanches are extremely destructive, but fortunately one of the least common volcanic hazards globally. Nevertheless, in BC's Garibaldi Volcanic Belt near Whistler (the

northernmost portion of the Cascade Volcanic Arc), volcanic eruptions during the Pleistocene and Holocene created many steep composite volcanoes which today are prone to debris avalanches. The instability of these volcanoes several thousand years after their last eruption results from their weak volcanic edifices coupled with the effects of glacial erosion, high groundwater pressures, and possibly seismic activity. An example of this type of volcanoes is found in the Mount Meager Volcanic Complex northwest of Pemberton BC.

Lahars

If a debris avalanche contains large quantities of water, it may continue as a **lahar** once the larger blocks of rock have settled out. Lahars are mudflows or debris flows formed by the mixing of pyroclasts and water (*lahar* is an Indonesian word for mudflow). The water can come from an impounded crater lake that is suddenly breached, heavy rain, or melting of a volcano's snow and glacier cover. While lahars are often created during an eruption, they can also occur years to decades following an eruption if a supply of erodible pyroclasts and water is available.

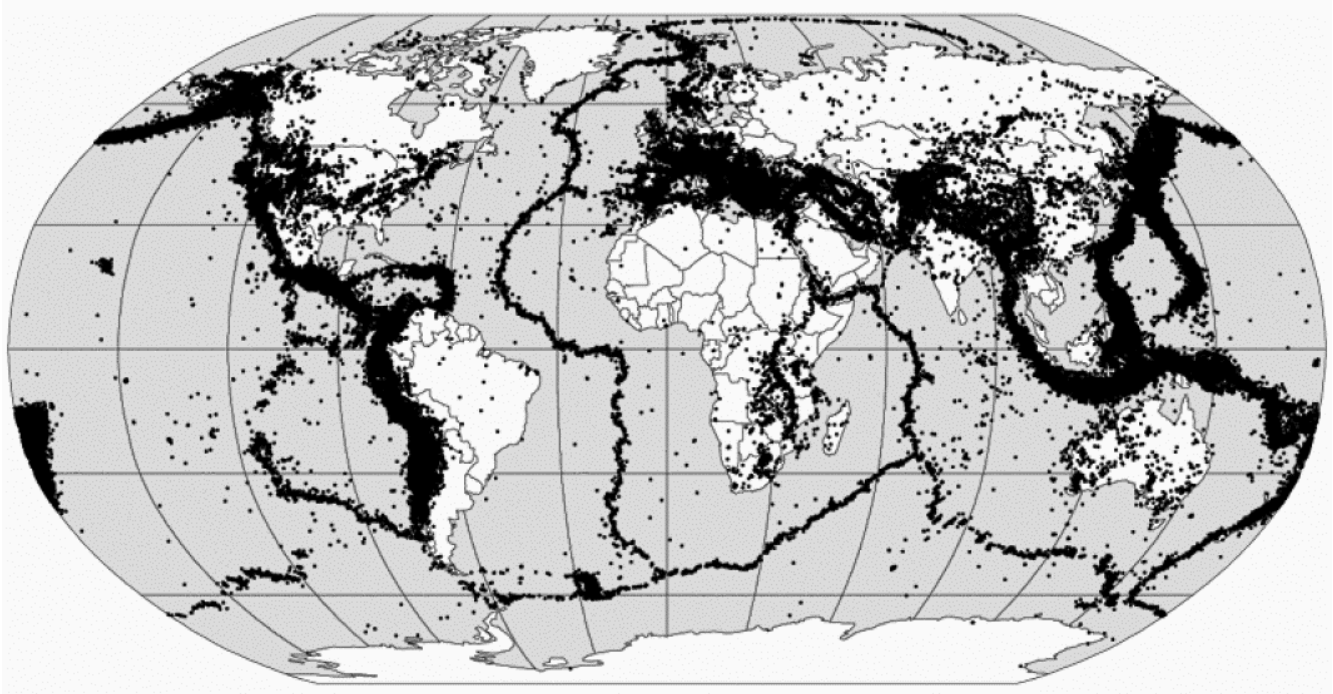
Volcanic Gases

While volcanic gases consist mostly of water vapour, other gases such as carbon dioxide, carbon monoxide, chlorine, sulphur, and fluorine compounds are also released during an eruption. Such gas emissions can be harmful or toxic within about 10 km of a volcano's vent when under specific atmospheric conditions. Also, volcanic lakes can accumulate a large volume of carbon dioxide deep within the lake's waters. When suddenly released to the lake's surface, the gas can asphyxiate any humans and animals in the lake's vicinity.

Earthquakes

Earthquakes occur where sections of the Earth's crust move past one another. Hence, earthquakes are most common along tectonic plate boundaries or along faults that exist within plates. Earthquakes also occur in association with the movement of magma in the subsurface. An earthquake is the product of a release of stress and movement of the crust. The location within the Earth where the earthquake motion is initiated is called the **focus**, while the point on the Earth's surface directly above the focus is called the **epicentre**.

The **epicentres** of most earthquakes show a remarkable coincidence with plate boundaries (Figure 18.2). Seismic activity along plate boundaries is related to the gradual build-up of stress. This occurs when two adjacent plates **stick together** but continue moving, causing the stuck parts to deform. The stress is released periodically and suddenly when the locked part of the plate boundary becomes **unstuck**. Earthquake motion results from a mechanism called **elastic rebound**, in which the plates that were deforming because they were locked together spring back to their original shape, releasing the stress. In general, the longer a section of plate boundary or fault has been stuck or **locked**, the stronger the earthquake will be when it eventually becomes unstuck. At subduction zones, the highest magnitude earthquakes occur at shallow depths where the adjacent plates are in contact, whereas the deepest earthquakes occur within the descending plate.

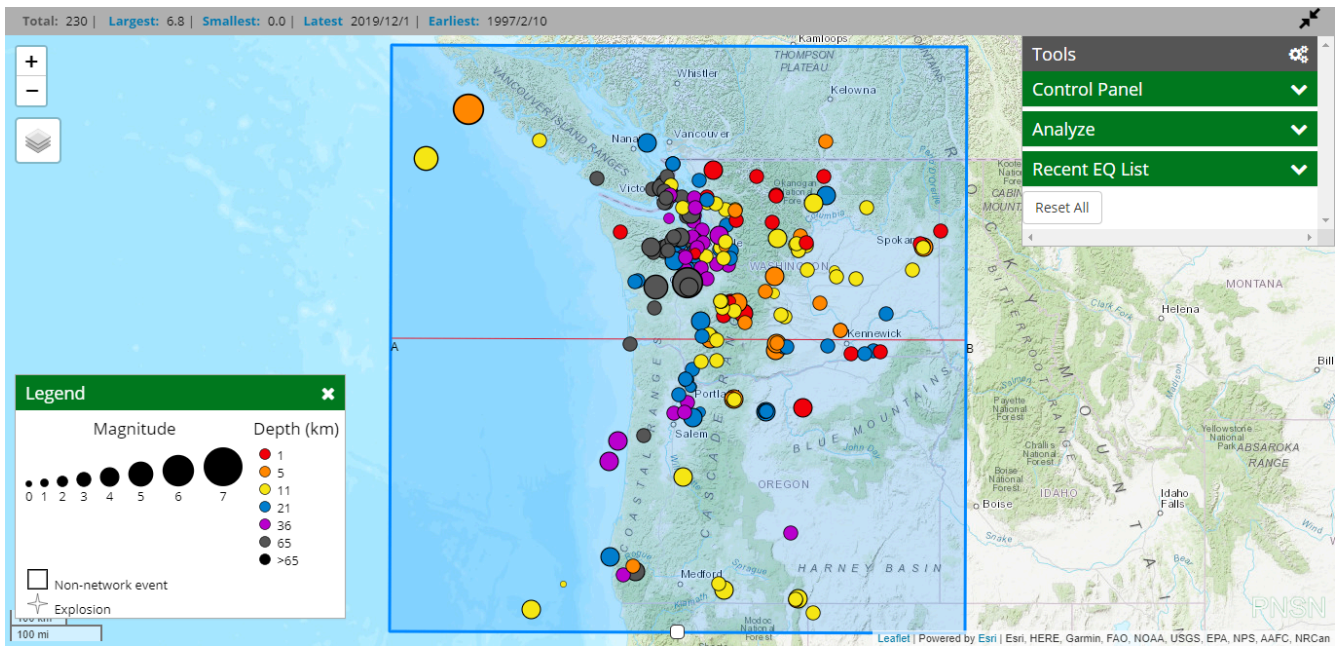


(<https://pressbooks.bccampus.ca/geoglabmanualv2/wp-content/uploads/sites/1032/2020/08/figure-16.2-earthquake-epicentres.png>)

Figure 18.2. Epicentres of global earthquakes from 1963 to 1998 indicated by black dots. Source: NASA, DTAM Project Team [PNG] (https://commons.wikimedia.org/wiki/File:Quake_epicenters_1963-98.png). Public Domain.

The strength of earthquakes is measured in two different ways (**Moment Magnitude** and **intensity**). An earthquake's **magnitude** is a quantitative measure of the amount of energy released. The **intensity** of an earthquake is a qualitative description of the amount of damage caused. Massive Moment Magnitude (**M**) 8-9 earthquakes called **megathrust earthquakes** occur periodically at converging plate boundaries when a plate **subducting** under an overriding plate becomes unstuck after the **subduction zone** has been locked for centuries.

The **Cascadia Subduction Zone** stretching offshore from Vancouver Island BC to northern California is one such subduction zone where a megathrust earthquake is expected to occur one day. Note that the seismic situation off the west coast of BC is complicated by the fact that diverging and transform plate boundaries are also present. The locations of notable earthquakes in the Pacific Northwest are depicted on Figure 18.3. Figure 18.4 shows the depth and magnitude of earthquakes for the cross section labelled A – B.



(<https://pressbooks.bccampus.ca/geoglabmanualv2/wp-content/uploads/sites/1032/2020/08/Figure-16.3-Epicentres-notable-PNW.png>)

Figure 18.3. The epicentres of notable earthquakes in the Pacific Northwest from 1997 to 2019. The size of the symbol is proportional to the magnitude of the earthquake, and colour indicates depth. Visit Pacific Northwest Seismic Network Notable Events (<https://pnsn.org/earthquakes/notable>) for an interactive version of the map. With the interactive version you may click on any point and the details of the event will be displayed in a pop-up box. Source: C. Welch adapted from screenshot taken 08/28/2020. Pacific Northwest Seismic Network Notable Events. (<https://pnsn.org/earthquakes/notable>) Used with permission.

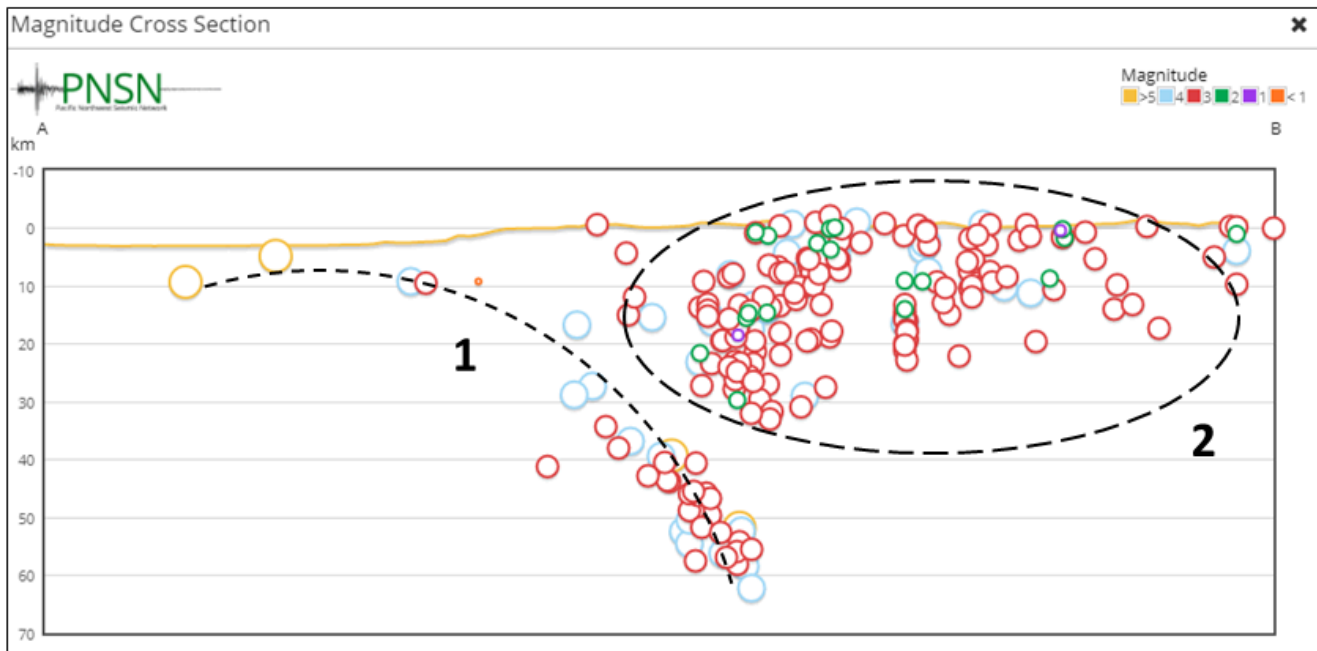


Figure 18.4. Cross section (A to B in Figure 18.3) showing depth and magnitude of notable earthquakes within the shaded area in Figure 18.3 (open circles). The solid yellow line shows the ground surface relative to sea level (0 m). Two separate groups of earthquakes are identified by the dashed black lines and labelled 1 and 2. You will identify the difference between the groups in EX3. Source: Adapted by C. Welch, with data from the Pacific Northwest Seismic Network Notable Events (<https://pnsn.org/earthquakes/notable>). Used with permission. [Image description]

Earthquake Hazards

Earthquake hazards are not as multi-faceted as volcanic hazards, and consist mainly of the seismic shaking that can damage or destroy buildings, transportation infrastructure, and other structures such as dams. Two secondary hazards that frequently accompany earthquake hazard are slope failures in mountainous terrain, and fires. One of the more well-known type of earthquake hazards are tsunamis.

Calculating Rates

A **rate** is the amount of change in some quantity over a given period of time. In this lab we are interested in rates of movement. Rate of movement is called velocity, and is the rate of change in distance per unit time. It is commonly expressed in kilometres per hour (km/h) and metres per second (m/s). The form of the relationship between distance travelled and time is shown in Equation 18.1:

Equation 18.1

$$\text{Velocity} = \frac{\Delta\text{Distance}}{\Delta\text{Time}}$$

For example, what is the velocity of a lava flow that travels 15 km in 10 hours? Using Equation 18.1,

$$\text{Velocity} = \frac{\Delta\text{Distance}}{\Delta\text{Time}}$$

$$\text{Velocity} = \frac{15 \text{ km}}{10 \text{ h}} = 1.5 \text{ km/h}$$

This relationship can be re-arranged to solve for distance or time. A good way to think about how the equation can be re-arranged is by examining the units of the output and making sure they make physical sense to you. For more detailed explanations, please refer to SERC Carleton's How do I calculate rates? Calculating changes through time in the geosciences (<http://serc.carleton.edu/mathyouneed/rates/index.html>) and How do I isolate x (or P or T ...) in a formula? Rearranging equations to solve for a given variable (<http://serc.carleton.edu/mathyouneed/equations/index.html>).

Calculating Return Periods

A **return period** (R_t) is the average amount of time between recurring events, such as floods, earthquakes, landslides, and volcanic eruptions. Return periods are also known as **recurrence intervals**. The units of return period are years (e.g., once every 100 years). To calculate return period, divide the number of years of record by the number of events (Equation 18.2):

Equation 18.2

$$R_t = \frac{\# \text{ years of record}}{\# \text{ events}}$$

For example, what is the return period for floods where 17 floods have been observed over the past 300 years?

$$R_t = \frac{\# \text{ years of record}}{\# \text{ events}}$$

$$R_t = \frac{300 \text{ years}}{17 \text{ floods}} = 17.6 \text{ years}$$

It is important to be aware that this simplified calculation of return period is based on a number of assumptions, most importantly, that there is no underlying systematic pattern within the data record. If you are interested in understanding more about this, read *Is the coast toast? Exploring Cascadia earthquake probabilities [PDF]* (<https://www.geosociety.org/gsatoday/groundwork/G350GW/GSATG350GW.pdf>). You are not required to calculate probability in the exercises in this lab.

Lab Exercises

In this lab we begin by using Google Earth (Web) (<https://earth.google.com/web/>) to track the path of a lahar as it moves downstream from the main crater of Mt. St. Helens, and calculating the return period of such events. Next, we calculate the rate of plate movement that produced the Anahim Volcanic Belt. Lastly, we identify the geographic and tectonic settings of recent earthquakes in Canada and the Pacific North West. This lab consists of three exercises and should take 1.5 to 3 hours to complete.

Where questions require you to calculate answers, please write the calculations on a piece of paper, clearly identifying the exercise and question number, and the data you used to obtain your answer. Once you have completed the lab, photograph this piece of paper and upload to your Learning Management System for review by your instructor. Check with your instructor to find out what file formats are acceptable. You will also create two KML files for upload.

EX1: Mt. St. Helens Lahar, 1980

During the eruption of Mt. St. Helens in 1980, a debris avalanche in the main crater developed into a lahar and eventually travelled down the North Fork Toutle River, into the Cowlitz River, and finally into the Columbia River at Longview, Washington. The lahar initiated at approximately 1:00 pm on May 18, 1980, and the flow reached the Columbia River at midnight.

Open Google Earth (Web) (<https://earth.google.com/web/>). Type **Mt. St. Helens** into the search feature (indicated by a **magnifying glass icon** at the top left of the screen) and Google Earth will take you there.

Create a Google Earth project containing the locations you need in order to answer this question.

Step 1: Click on the **Projects** icon (fifth down the list on the left of the screen). Select **New Project** then **Create KML file**.

Step 2: Click on the **pencil** icon and label the project **Mt. St. Helens Lahar**.

Step 3: Add and label a placemark for the start point (the summit) using the dropdown menu **New feature**.

Step 4: Add and label a placemark for the end point of the lahar (the confluence of the Cowlitz and Columbia rivers at Longview, Washington) using the dropdown menu **New feature**.

Step 5: Using the **Measure distance and area** tool in Google Earth (**ruler** icon on bottom left of screen), trace the flow path of the lahar between the start and end points you identified. Note that the lahar travelled from the summit crater of Mt. St. Helens along the North Fork of the Toutle River and down the Cowlitz River to meet the Columbia River at Longview, Washington.

Note: The line you draw with this tool has large dots which are the points you clicked. If you want to adjust the location of the line, double click on one last point to pause your measurement. Notice that your line now has large dots in the locations that you clicked and small dots at intermediate points. You can click on and drag either dot type to adjust your line. If you adjust a small dots, they become large dots, and new small dots appear between them. When you are ready to continue your line, click on the last large dot and drag it in the direction you want to continue your measurement. You can only extend the measurement in a straight line, but you can adjust the measurement line using the procedure just described.

1. What is the flow path distance of the lahar between the summit crater at the top of Mt. St. Helens and the confluence of the Cowlitz and Columbia Rivers (in km)?
2. What is the average flow velocity for the lahar in units of km/h and m/s? Show your work.
3. The measured flow velocity of the lahar varied over the full travel distance. Where do you think the flow velocity would have been highest? Explain your rationale.
4. Examine the imagery of Mt. St. Helens in Google Earth (Web). What do you think is the most probable source of water for the lahar?
5. Record the coordinates and elevation for the locations where the lahar started and finished in Table 18.2. This information can be obtained by pointing the **finger** of your cursor at the base of

the placemark of the point of interest and reading from the coordinates in the bottom-left of the screen. Elevation has units of metres above sea level (m ASL).

Table 18.2. Coordinates and elevation of the start and finish of the Mt. St. Helens lahar.

Location	Latitude	Longitude	Elevation (m ASL)
Mt. St. Helens summit crater			
Confluence of Cowlitz and Columbia River (Longview WA)			

6. Calculate the average gradient along the flow path between the summit crater and the confluence of the Cowlitz and Columbia Rivers using the data you collected in Q1 and Q4. Express it as
 - a. percent (%)
 - b. elevation change per slope distance (m/km)

Show your work. If you require a refresher on calculating gradient, please refer to Lab 16 Calculating Slope Gradient.

7. Geologic evidence indicates a long history of relatively frequent lahars associated with Mt. St. Helens. Over the past 4500 years, there is evidence of 15 separate lahar events. What is the average return period of lahars over this period of time? Show your work.

EX2: Determining Rates of Tectonic Plate Movement

We can use hotspot volcanic chains to track the rate and direction of the movement of Earth's tectonic plates by assuming that mantle plumes and the hotspots they generate are stationary. In this exercise you will use the Anahim Volcanic Belt (Figure 18.1) to determine the rate and direction of movement of the North American plate. Use the average ages of each feature provided in Table 18.3 for your calculations.

Table 18.3. Volcanic features of the Anahim Volcanic Belt.

#	Feature	Latitude (N)	Longitude (W)	Age (Ma)
1	Dike swarm convergence point	52°28'28.08"	128°16'27.41"	13
2	Rainbow Range	52°43'25.41"	125°46'44.50"	8
3	Ilgachuz Range	52°47'11.38"	125°19'21.91"	5
4	Itcha Range	52°42'12.14"	124°51'02.05"	2.5
5	Nazko Cone	52°55'38.21"	123°44'01.85"	0.0072

Add each of these volcanic features to a new project in Google Earth (Web) (<https://earth.google.com/web/>).

Step 1: Create a new project following the instructions provided for EX1 and label it **Anahim Volcanic Belt**.

Step 2: Insert and label placemarks for each of the volcanic features using the coordinates in Table 18.3. When you copy and paste the coordinates into the Google Earth (Web) (<https://earth.google.com/web/>) search tool, be sure to include the **N** after the latitude and the **W** after the longitude.

- Using the **Measure distance and area** tool (**ruler** icon on left of screen) in Google Earth (Web), measure the distance between each of the features and record your measurements in Table 18.4.

Table 18.4. Distance between volcanic features of the Anahim Volcanic Belt.

From	To	Distance (km)
Dike swarm convergence point	Rainbow Range	
Rainbow Range	Ilgachuz Range	
Ilgachuz Range	Itcha Range	
Itcha Range	Nazko Cone	

- Calculate the rate of tectonic plate movement between each of the sets of volcanic features in units of mm/yr and record in Table 18.5. Show your work. **Hint:** Use the age of the features provided in Table 18.3 and the distances you recorded in Table 18.4.

Table 18.5. Rate of tectonic plate movement between each set of volcanic features.

From	To	Movement rate (mm/yr)
Dike swarm convergence	Rainbow Range	
Rainbow Range	Ilgachuz Range	
Ilgachuz Range	Itcha Range	
Itcha Range	Nazko Cone	

- In which cardinal direction is the North American plate moving? What evidence do you have to support your answer?
- Has the movement rate been constant through time? Explain your rationale.

EX3: Identifying the Geographic and Tectonic Settings of Earthquakes

This exercise has three parts:

- obtaining data about recent earthquakes in Canada;
- identifying locations of earthquakes in the Pacific Northwest; and
- calculating the return periods of megathrust earthquakes at the Cascadia Subduction Zone.

The Canadian Geological Survey monitors earthquakes through a global seismometer network. The locations, depths and magnitudes of Canadian earthquakes can be seen on the NRC Earthquakes Canada website (<http://www.earthquakescanada.nrcan.gc.ca/index-en.php>).

12. Scroll down to the map depicting all earthquakes of the last 30 days in Canada. What is the tectonic setting (plate boundary type) for most of the earthquakes? Be as specific as you can.
13. Select **Region: Western Canada** using the region selector at the top left of the map. You can expand the **Legend** by clicking on it. It is located in the bottom-right corner of the map. Circle size reflects earthquake magnitude, whereas colour represents time since occurrence. You may also view information in a table by clicking on **List points plotted in the map** located immediately below the map. You may have to scroll down below the map to the tabulated data when the new screen opens.
 - a. Take a screenshot of the data (map or table). Submit this with your assignment.
 - b. What was the magnitude (M-scale) of the largest earthquake in this region? **Hint:** You can sort the table data by magnitude by clicking on the **Magnitude** column heading.
 - c. Where was it located?
 - d. What was the depth of this earthquake?
14. Select **Region: Eastern Canada**.
 - a. Take a screenshot of the data (map or table). Submit this with your assignment.
 - b. What was the magnitude (M-scale) of the largest earthquake in this region?
 - c. Where was it located?
 - d. What was the depth of this earthquake?
15. Figure 18.3 shows the locations of notable earthquakes in the Pacific Northwest region over the period of 1997 to present. Open Google Earth (Web) (<https://earth.google.com/web/>) and determine what surface features the cluster of earthquakes in the centre of the image are associated with. **Hint:** If you want to look at Figure 18.3 in more detail, open the Pacific Northwest Seismic Network Notable Events (<http://pnsn.org/earthquakes/notable>) website and zoom into the regions of interest. Click on any point and the associated data will be displayed in a pop-up window.
16. Figure 18.4 shows a cross section (from A-B in Figure 18.3) of these notable earthquakes in the Pacific Northwest. Two main groupings of earthquakes are identified on Figure 18.4, labelled 1 and 2 and indicated by dashed lines. Which geologic/tectonic processes are causing each group of

- earthquakes, and in which type of tectonic plate are they occurring?
17. Cores obtained from the seafloor off the coast of southern BC and Washington state show evidence of 41 megathrust earthquakes in the past 10,000 years at the Cascadia Subduction Zone (CSZ).
 - a. What is the average return period of megathrust earthquakes at the CSZ? Show your work.
 - b. Given that the last megathrust earthquake at the CSZ occurred on 26 January, 1700, in which year do you expect the next one to occur? Show your work.
 - c. How certain are you that the next megathrust earthquake will occur on the date you calculated in 17(b)? Provide a qualitative explanation. You do not have enough information to calculate probability mathematically.

Reflection Questions

1. The return period you calculated for lahars at Mt. St. Helens in EX1 is an average return period. When do you think lahars will be most common at Mt. St. Helens? Explain the rationale for your answer.
2. What type of volcanoes are present in the Rainbow, Ilgachuz and Itcha Ranges? List the evidence you have to support your answer.
3. In which geographic location do you think the majority of damage will be when the next megathrust earthquake occurs in the CSZ? What kind of damage is likely? Explain your rationale.

Image Descriptions

Figure 18.4. Cross section (A to B in Figure 18.3) showing depth and magnitude of notable earthquakes within the shaded area in Figure 18.3 (open circles)

A cross-section of the Pacific Northwest along the horizontal line marked on Figure 18.3 between points A and B. The horizontal distance is on the x axis (no scale provided) and the depth below the ground surface is shown on the y axis in kilometres. 0 m is mean sea level. The ground surface is depicted by a solid yellow line. The position of each circle on the cross section represents the depth of a single earthquake below the ground surface, which is also known as the focus. The colour of each circle indicates the magnitude. A legend for magnitude is located in the top-right corner of the figure. Two separate groups of earthquakes are identified by dashed black lines. The general shape of Group 1 is a curve that starts near sea level in the west and descends deeper below ground level to the east. Group 2 is a cluster of earthquakes that is less deep than the lowest portion of Group 1 and to the east, which is inland.

[Return to Figure 18.4]

Lab 19: Catchment Analysis

Chani Welch and Fes de Scally

Catchments, also known as **watersheds** and **drainage basins**, are fundamental units of the terrestrial landscape. Their boundaries are system boundaries for hydrological, geomorphological, and ecological processes. In brief, all precipitation that falls on a catchment drains to a single low, outlet point. This movement of water creates physical connections between all parts of a catchment. As a result, activities in one part of a catchment can influence water movement in another.

In this lab you will explore catchment attributes that control the rate and timing of surface water flow through catchments. You will differentiate hydrographs produced in response to rainfall based on catchment attributes. You will gather your own measurements of catchment characteristics using Toporama and analyze the data at two different scales.

Learning Objectives

After completion of this lab you will be able to:

- Understand and predict some of the effects of catchment attributes on stream discharge.
- Understand links between surface water and groundwater in catchments.
- Delineate a catchment using online mapping platforms.
- Measure and analyze catchment and stream network attributes using online mapping tools.
- Understand and predict the effects of map scale on the perceived complexity of the catchment and stream network and measured attributes.

Pre-Readings

Catchments as Systems

At the global scale, the hydrological cycle describes the movement of water between continents, oceans, and the atmosphere. Hydrologists and geomorphologists are generally more interested in assessing the hydrological cycle at the smaller scale of catchments. Catchments are a unique areal unit of the terrestrial landscape. The various names we use for this physical unit provide clues as to why catchments are unique units:

- **Catchment**: This area **catches** all water that falls onto it as precipitation.
- **Watershed**: This area **sheds** all water that falls on it to a single point.

- **Drainage** basin: All water that falls onto this area **drains** to a single point.

In summary, a catchment may be defined as an area of land that drains all water to a single outlet point. The outlet is the lowest point in the catchment. In other words, water moves from areas of higher elevation to areas of lower elevation. The boundary of a catchment is called a **drainage divide**, as it divides drainage into one catchment or another. It can be visualized as the highest point of land separating one catchment from adjacent catchments. Sediment eroded from a catchment by glacier ice or running water cannot be transported across the drainage divide into an adjacent catchment by water movement. Likewise, fish cannot migrate over a divide into an adjacent catchment.

Most commonly, the outlet of a catchment is a river mouth, where the river discharges water and sediment into the downstream lake, river, or ultimately, the ocean. In contrast, the outlet of some catchments is a depression in the landscape that forms a lake (at least some of the time). This type of catchment is called a closed catchment. All precipitation that falls on this type of catchment flows to the outlet where it either evaporates or infiltrates into the ground. A local example of this type of catchment is White Lake, south-east of Penticton, BC.

Drainage Networks

Each catchment contains a stream network that channels surface water to the catchment outlet. Depending on the size of the catchment, these streams range in number from one or two to tens of thousands. Each catchment has a main stream into which tributaries deposit water and sediment. The smallest tributaries, furthest from the catchment outlet, are called **headwater** streams. These are the streams where rivers begin. Although they carry smaller volumes of water, they often cover a significant portion of the total length of streams in a catchment, and play important roles in recharging groundwater, containing flood water, improving water quality, and providing fish and wildlife habitat.

One way of assessing the complexity of a stream network is by ordering the streams in a catchment into a hierarchy. The most common method used to define **stream order** is the Strahler method (Figure 19.1):

1. Starting at the uppermost points in the catchment, all headwater, or unbranched tributary streams are given a stream order of 1, and called first-order streams.
2. When two first-order streams join, the stream order increases to 2 (second-order).
3. When two second-order streams join, the stream order increases to 3, and so on.

Note that the stream order **does not** increase if two streams of different orders join. The highest stream order becomes the catchment order, so for example, Figure 19.1 depicts a **fourth-order** catchment.

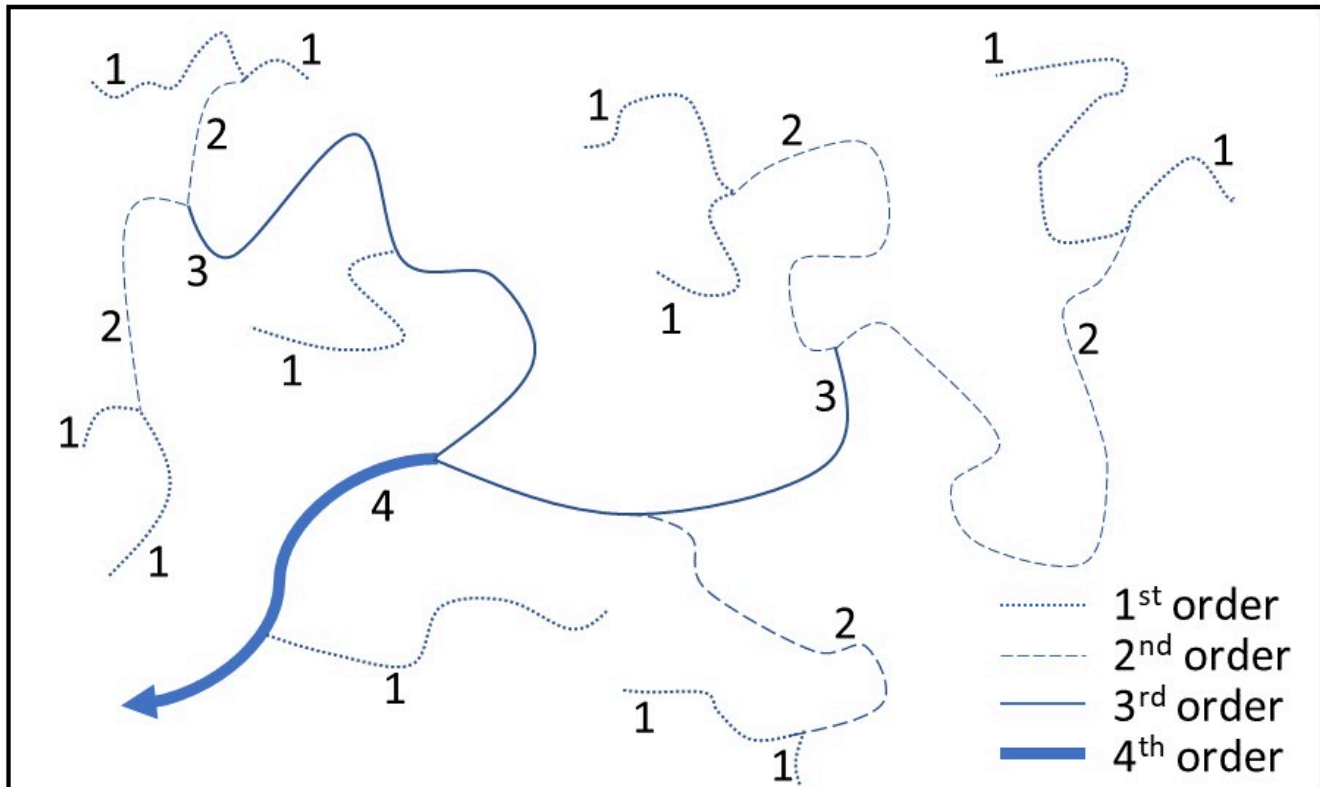


Figure 19.1. Strahler system of stream ordering. This is an example of a **fourth-order** catchment. Water in this stream network flows from the headwater, or 1st order streams, to the outlet at the mouth of the 4th order stream (indicated by arrow head in bottom-left corner). Source: C. Welch, CC BY-SA 4.0.

The stream or drainage network can also be described on the basis of its shape, or **drainage pattern**. Different patterns are usually the result of structural or lithologic controls and include:

1. **Dendritic:** develops in regions where there are no clear-cut structural or lithologic controls, i.e., areas with homogeneous geology. The most common drainage pattern and the most energy efficient because the length of tributaries is minimized.
2. **Trellis:** develops in areas of strong structural or lithologic control, in particular where there are differentially eroded rock bodies and the streams flow along the **strike** of the less competent rocks that have been eroded. Tributaries flow down slopes to enter the main streams at right angles.
3. **Parallel:** often develops on steep slopes. Tributaries are parallel to each other.
4. **Rectangular:** develops in a faulted and jointed landscape, which directs stream courses in patterns of right angle turns.
5. **Deranged:** develops where the original stream network has been disturbed, has no clear geometry, and no true stream valley. Particularly common on the Canadian Shield which was deeply scoured by ice sheets during the last glaciation.

Stream Discharge

The quantity of water flowing down a stream is called stream **discharge**. It is measured as a volumetric

flow rate, most commonly cubic metres per second (m^3/s , also known as cumecs). Discharge is commonly plotted against time; this is known as a **hydrograph**. Discharge is controlled by catchment size, shape and relief, drainage pattern and density, climate, land cover, in-stream controls, and the underlying geology.

Generally, as catchment size increases, discharge also increases. Major exceptions to this are 1) **exotic** streams that have their headwaters in temperate climates and lower reaches in arid climates, and 2) rivers that from which large quantities of water are removed by human activities. These two situations commonly occur in the same river system, such as the Columbia River system in North America.

Catchments can possess an infinite variety of shapes, reflecting the history, structure and rocks of a region. **Shape** plays a major role in controlling the time sequence by which water enters the main stream of a catchment, and hence the timing of flood peaks (highest point on discharge curves; Figure 19.2). Elongated catchments tend to produce smaller flood peaks than rounded or tear-shaped catchments because the arrival of rainfall runoff at the mouth is staggered over a longer period of time (Figure 19.2c). In rounded or tear-shaped catchments (Figure 19.2a, b), runoff arrives at the mouth at more or less the same time from all tributaries.

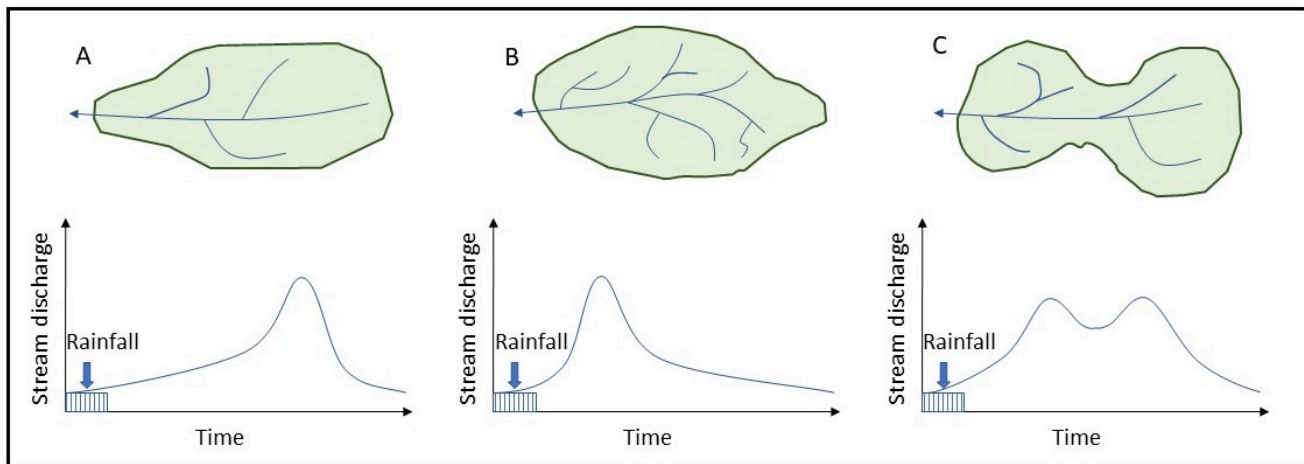


Figure 19.2. Hypothetical effect of catchment shape on discharge response to a rainfall event. Source: C. Welch, CC BY-SA 4.0.

Catchment **relief**, the difference in elevation between the highest and lowest parts of the catchment, is also controlled to a large degree by geological structure. A catchment with greater relief will have a faster runoff and discharge response to a rainfall event.

Drainage density is defined as the length of stream channels per unit area of a catchment. Drainage density reflects land use, underlying geology, and affects infiltration and the response time between rainfall and runoff. In general, higher drainage densities (Figure 19.3b) result in larger flood events because water travels shorter distances overland (a relatively slow process) before reaching a stream and hence less time to infiltrate into the ground when compared to catchments with lower drainage densities (Figure 19.3a). Because water reaches stream channels more quickly, higher drainage densities also lead to earlier flood peaks. In terms of geomorphology, it plays a role in the development of slopes.

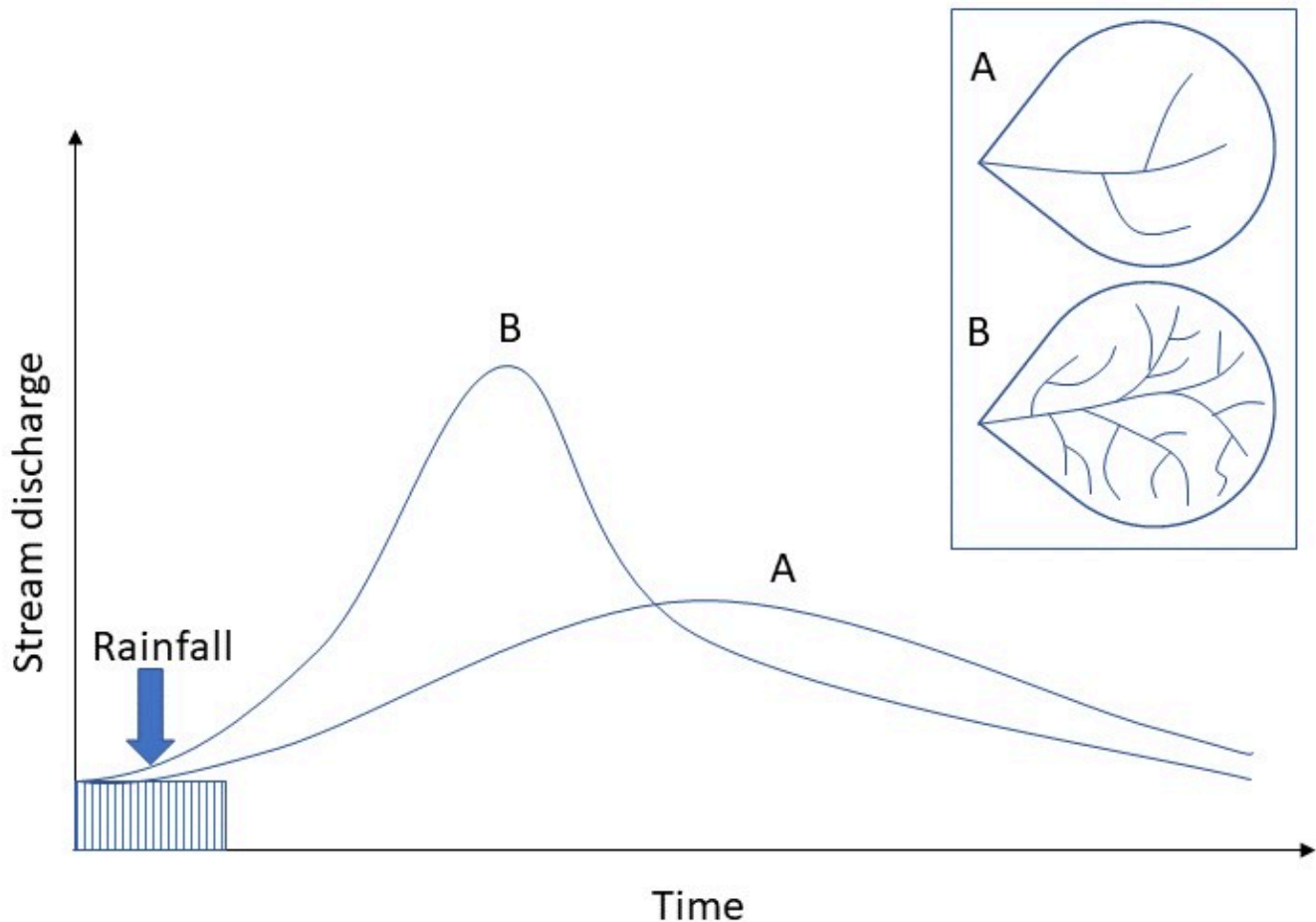


Figure 19.3. Hypothetical effect of drainage density on discharge response to a rainfall event. a. Low drainage density results in a lower flood peak. b. High drainage density results in a larger flood peak. Source: C. Welch, CC BY-NC-SA 4.0.

Streams may be either **perennial** (always have discharge), **intermittent** (only discharge when there is enough water coming from upstream or groundwater, for example, glacier melt, usually seasonal) or **ephemeral** (only flow in response to rainfall events). The latter two are most common in arid environments. In-stream controls such as dams separate discharge at catchment outlets from rainfall events by controlling discharge to optimize power generation or minimize flood risk in downstream areas.

Land cover can affect drainage patterns (consider irrigation ditches, for example, or channelized portions of rivers) and the conversion of rainfall to infiltration versus runoff. Urban catchments, for example, tend to be covered with less permeable cover (concrete, rather than trees or grass), and so generate flood peaks that are higher and occur more quickly than an equivalent natural catchment.

Morphometric Attributes of Catchments

Catchment morphometrics (**morpho** = form; **metrics** = measures of) provide quantitative tools for comparing the control that catchment attributes have on the timing and rate of stream discharge. We will look at two catchment and one stream network metric.

One of the most common ways to measure catchment shape is using **Schumm's Elongation Ratio (E)** (Equation 19.1):

Equation 19.1

$$E = \frac{D}{L}$$

where D is the diameter of a circle with the same area as the catchment, and L is the horizontal distance along the longest axis of the catchment parallel to the main stream (Schumm, 1956).

Schumm (Schumm, 1956) also developed a simple measurement of catchment relief, known as **Schumm's Relief Ratio (R)** (Equation 19.2):

Equation 19.2

$$R = \frac{H}{L}$$

where H is the difference between the highest and lowest elevations in the catchment, and L is as defined above for E in Equation 19.1.

Note that E and R are both unitless. Ensure that D and L, or H and L have the same units prior to calculating. Common units are metres (m) or kilometres (km).

Drainage density (D_d) is defined as the length of stream channels per unit area of a catchment (units of km / km² or km⁻¹) (Equation 19.3):

Equation 19.3

$$D_d = \frac{L(km)}{A(km^2)}$$

where L is the total length of all streams in the catchment (in kilometres) and A is the area of the catchment (in square kilometres, km²).

Groundwater Connections

When precipitation falls on a catchment, some portion of the water may infiltrate into the ground, and continue below the root zone into groundwater. The amount of precipitation that reaches the groundwater is determined by the characteristics of the local geology, plant use, and the timing, volume and intensity of precipitation events.

Areas where precipitation infiltrates into groundwater are known as recharge areas, and areas where groundwater returns to the surface, for example, into a river or a lake as a spring, are known as discharge areas. Recharge and discharge areas are sometimes very close to each other (tens of metres)

and sometimes hundreds of kilometres apart. They are sometimes contained within a single surface water catchment, and sometimes are not.

The types of geology that increase the amount of groundwater flow are those that contain very permeable rocks, or lots of fissures and fractures for water to easily flow through. Limestone is one example of a very permeable type of rock. Water flows more slowly through the subsurface than in surface streams due to the extra resistance provided by the rock or soil.

In many areas, surface water flow plays a more active role in landscape formation than groundwater, and hence is the focus of this lab. However, groundwater, or its removal, does also play an active role in shaping landscapes. For example, subsidence can occur when large amounts of groundwater are removed from an aquifer; the overlying land sinks, changing catchment relief. Groundwater springs also sustain headwater lakes and streams.

Introduction to Toporama

Toporama (<https://atlas.gc.ca/toporama/en/index.html>) is an online mapping tool provided by Natural Resources Canada. The maps include:

- Ground relief.
- Lakes and rivers.
- Administrative and populated areas.
- Roads and transport facilities.

You can select the layers that you wish to display. You can also choose the base layer of your map (e.g., Canada Base Map or satellite imagery). Toporama enables you to measure features, annotate, and export maps of your own creation.

Please note that while Toporama is a wonderful tool, it can be slow to load. Your patience is appreciated. If you have persistent problems, clear your cookies/cache and/or reboot your computer.

Lab Exercises

In this lab you will analyze a catchment using tools available in Toporama (<https://atlas.gc.ca/toporama/en/index.html>). You will

- Learn how to delineate a catchment and assess this delineation.
- Measure catchment and stream characteristics at two different scales.
- Calculate catchment morphometrics.
- Assess the effects of catchment attributes on discharge.

You will need access to a computer with internet connection to access Toporama (<https://atlas.gc.ca/>

toporama/en/index.html) and a calculator. It is estimated that this lab will take 2-3 hours to complete, depending on your familiarity with Toporama.

EX1: Catchment Characteristics and Discharge

A number of lowland catchments (i.e. catchments with no appreciable relief) with different shapes, sizes and characteristics are shown on Figure 19.4. Assume that all catchments receive a similar amount of rainfall over a similar period of time from a summer storm. The hydrographs A to H in the lower half of the figure represent the discharge response of each catchment at the numbered locations.

1. Match each catchment with the appropriate hydrograph, basing your choice on the catchment characteristics that affect the discharge: size, shape, stream network, surface land cover, underlying geology, and climate. Refer back to the introductory material as necessary.

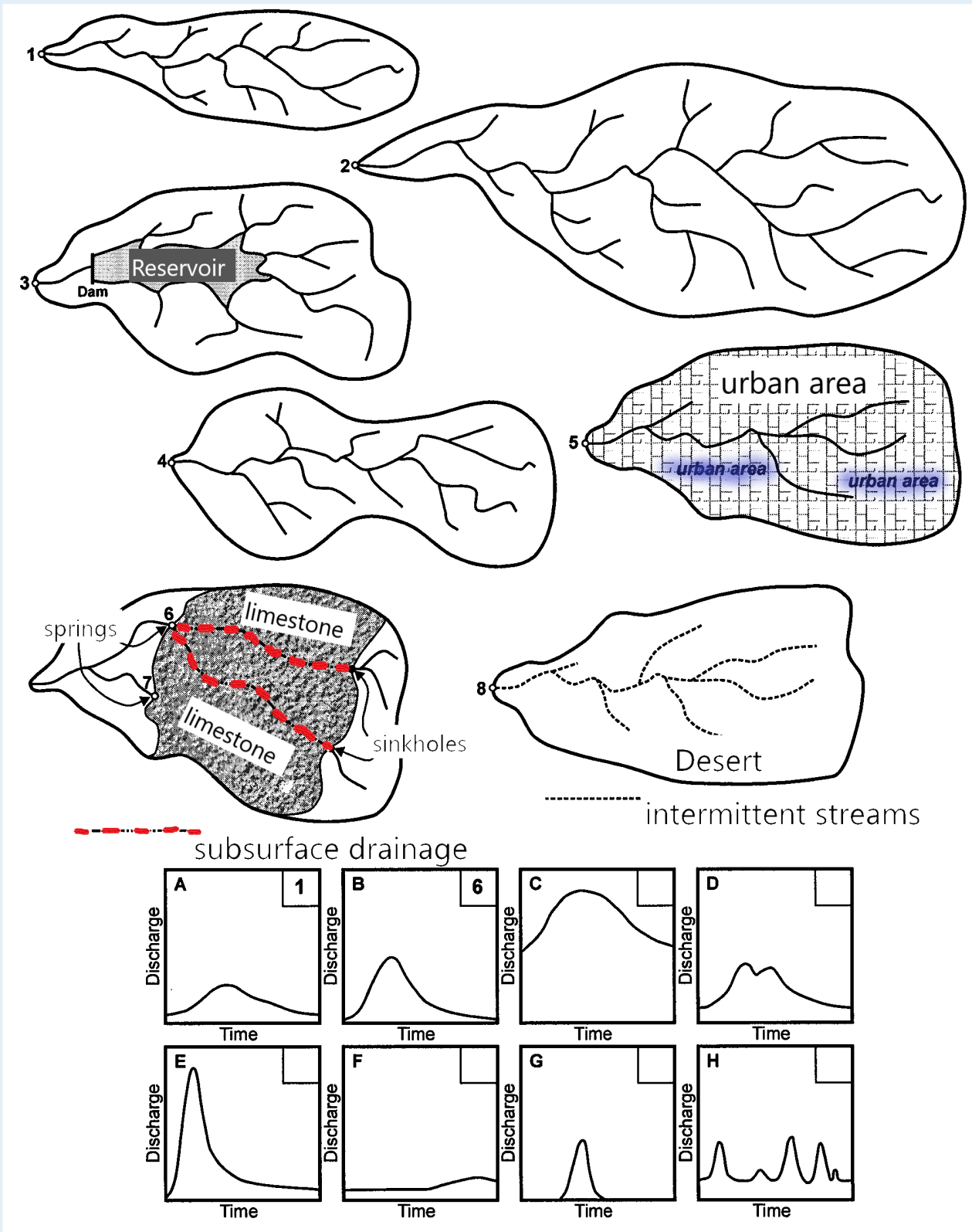


Figure 19.4. Catchments and their hydrographs. Each catchment has a gauging station at the numbered location(s). These gauging stations provide the data from which the hydrographs were constructed. Source: Adapted by C. Welch, CC BY-NC-SA 4.0. [Image description]

EX2: Analyzing a Catchment at a Small Scale

Delineating a catchment is the first step in analyzing hydrological processes at this scale. To delineate a catchment means to draw the catchment boundary, or in other words, define the drainage divide between your catchment of interest and adjacent catchments. Once the catchment is delineated, you can take the measurements necessary for further analysis.

In this lab you will work with the catchment of **Scotty Creek**, a creek located north-east of the city of Kelowna. Open Toporama (<https://atlas.gc.ca/toporama/en/index.html>) and complete the following steps to obtain the map you need at the appropriate scale:

Step 1: Type **Scotty Creek** into the search bar. It is located in the Menu box under **Search and Map Information**, titled **Find a Location**.

Step 2: Select the first option, **Scotty Creek, Osoyoos Division Yale Land District, British Columbia (River)**.

Step 3: Click on the map and zoom out until the bar scale located in the bottom-right corner shows a total distance of 2 km.

Step 4: Click on the **x** of the Location pop out so that you have a clear view of the catchment.

You are now ready to delineate your catchment and measure some important characteristics. All the measuring and drawing tools are located in the **Menu** under **Measuring and Drawing Tools**. You can click on the **speech bubble with a question mark (?) in it** at any time to get more information on how the tools work.

2. Use the bar scale to calculate the ratio scale of the map. Assume that the length of the bar scale is 2.35 cm. Provide your answer correct to the nearest 1000. Show your work.
3. Catchment delineation and stream ordering:
 - a. Use the **Measure Area** tool (**ruler and closed shape icon**) to delineate the Scotty Creek catchment. Use the stream network and topographic contours as a guide. Be sure to check the box **Draw values on map** the first time you use this tool. Double click to indicate that you are finished drawing.

Hint: There are two golden rules to defining any catchment boundary:

 - Water always flows from higher elevation to lower elevation; and
 - Streams never cross a drainage divide.
 - b. Order the stream network using the method illustrated on Figure 19.1. Annotate the map using the **Add text** tool (**text icon (Aa)**). Type the number into the **Add text** box that opens, click **ok** and the click on the map to place the number on the stream you want it on. Once you have finished labelling the streams, click **cancel** to exit the tool.

Once you have completed the catchment delineation and stream ordering, click on the **printer icon** in the top-right corner to print a copy of your map. Be sure to check **Force scale** so that the map retains the correct scale. Save as a PDF to a known location on your computer.

4. Using the map you created in Q3, answer the following questions:
 - a. What is the area of the Scotty Creek catchment (to the nearest km²)?

- b. What is the catchment order?
5. Use the **Measure a path** tool (**ruler and line icon**) to measure the following:
 - a. The length of all the streams in the catchment. The total length of your path is displayed on the map after you double click on the last point. Provide your answer to the nearest km.
 - b. The length of the longest axis parallel to the main stream in the catchment (to the nearest 0.5 km).
6. Use the topographic contours to estimate the catchment relief (to the nearest 50 m).
 - a. What is the highest elevation?
 - b. What is the lowest elevation?
 - c. What is the catchment relief?
7. You have been working with a small-scale map. What major challenge do you see in identifying catchment morphometrics at this scale?

EX3: Analyzing a Catchment at a Large Scale

Now, let's see what happens when we increase the map scale so that we can look at the landscape in more detail. Before doing so, clean up your map using the **undo** tool so that all you can see is your catchment area. If you accidentally erase your catchment area, click the **Redo** button to get it back. Click on the map and zoom in until the bar scale shows a total distance of 1 km, but does not appear to be much longer than it was in the previous exercise.

Move the map so that you can still see your whole catchment on the screen. You may need to minimize the **Menu box** to do this (click on the **arrow pointing down**).

8. Use the bar scale to calculate the ratio scale of the map. Assume that the length of the bar scale is 2 cm. Provide your answer correct to the nearest 1000. Show your work.
9. Inspect the catchment boundary that you drew at the smaller scale. Is the delineation appropriate at this larger scale? Why or why not? Use the **Draw lines** tool to circle three areas where the delineation is no longer appropriate. Use the **Add text** tool to number these locations, and then explain what is wrong with each. Print and save a copy of your map at this point.
10. Use the **Erase all** function to remove all annotations from the map. Delineate the catchment and order the stream network at this larger scale. Print a copy of your map that shows the revised catchment area and stream order and save to a known location.
11. Obtain the measurements you need to analyze the catchment at this scale. Complete Table 19.1 with your measurements. Note that the total length of streams is provided for you. Be sure to provide your answers in the units indicated.

Provide all measurements to the nearest integer (whole number) except elevations/relief (provide to the nearest 50 m).

Table 19.1 Large-scale catchment measurements.

Action	Data
Catchment	–
Catchment Area (km ²)	
Length of longest axis parallel to the main stream in the catchment (km)	
Highest elevation (m)	
Lowest elevation (m)	
Catchment relief (m)	
Stream Network	–
Catchment order	
Total length of streams (km)	65

12. Compare the measurements you obtained with the large-scale map to the measurements you obtained with the small-scale map. Have they changed? Why or why not? You may wish to toggle between the two scales in Toporama to help answer this question. Specifically compare:
 - a. Catchment area.
 - b. Catchment order. **Hint:** consider the stream order that increased the most between the small-scale and large-scale maps.
 - c. Total length of streams.
 - d. Catchment relief.
13. Using the measurements obtained at the large-scale, calculate the following catchment morphometrics. Show your work.
 - a. Schumm's Elongation Ratio (E). **Note:** Diameter of a circle = $2r$
Area of a circle = πr^2
 - b. Schumm's Relief Ratio (R).
 - c. Drainage density (D_d).
14. How would you describe the drainage pattern of Scotty Creek?
15. Based on the catchment morphometrics,
 - a. How do you think Scotty Creek would respond to a large rainfall event in the summer? Explain.
 - b. Would your answer be different if you used the measurements obtained from the smaller scale map?

Reflection Questions

1. A circular catchment has an Elongation Ratio of 1. Compare this value to the E you calculated for your catchment. Assume that both catchments have a gauging station at their outlet. Describe the expected differences in the hydrograph generated by a summer rainstorm of equal magnitude.
2. Which of the morphometric attributes calculated in this lab provide you with the most information on flood potential? Explain.

References

Schumm, S.A. (1956). The evolution of drainage systems and slopes in bad lands at Perth, Amboy, New Jersey. *Geological Society of America Bulletin*, 67(5), pp. 597-646. [https://doi.org/10.1130/0016-7606\(1956\)67\[597:EODSAS\]2.0.CO;2](https://doi.org/10.1130/0016-7606(1956)67[597:EODSAS]2.0.CO;2)

Image Descriptions

Figure 19.4. Catchments and their hydrographs.

Figure 19.4 is composed of two portions. In the top portion of the figure are eight diagrams of catchments of different sizes and shapes. Flowing streams are indicated by solid lines, subsurface drainage by red long-dashed lines, and intermittent streams by dotted lines. Each catchment has a number and circle at the catchment outlet. This is the location where discharge is to be assessed. The bottom portion of the figure contains eight boxes with graphs showing the change in discharge over time. Discharge is plotted on the y axis and time is plotted on the x axis. In the top-right corner of each large box is a small box where the matching catchment number can be written. The first two matches have been completed for you.

[Return to Figure 19.4]

Lab 20: Water Cycle and Water Resources

Craig Nichol

Water, like air, is one of the key fluids that helps to move energy and matter around on Earth. Water is endlessly cycled on Earth from the oceans up into the atmosphere, and down onto the land by the power of the sun. Fresh water on land is a critical nutrient for all life, as well as creating habitat for life through the water in the soil, deeper in the ground, in rivers and in lakes. Physically, water acts to erode sediments, and chemically, it carries dissolved materials back to the ocean. Earth's ice caps and glaciers act as massive stores of fresh water. All the phases that water can take on (gas, liquid, solid) are interconnected as one seamless whole, endlessly circulating through the **water cycle**.

This lab explores the different flow processes of water within a single watershed and examines how those processes interact. It examines what happens to the natural water cycle when humans choose to divert water from its natural flow, and to use it for another purpose. Any water pumped from either surface water or from groundwater eventually leads to a decrease in the surface water flow within the watershed. You will expand your understanding of the different flow processes by plotting graphs of precipitation, groundwater level, and stream discharge, and by observing and explaining the interactions between these components.

Learning Objectives

After completion of this lab, you will be able to

- Describe the distribution of water and freshwater on Earth.
- Plot precipitation on a daily or annual basis.
- Plot surface water flow using a hydrograph.
- Plot groundwater levels and determine changes in groundwater storage.
- Describe how the pumping of surface water or groundwater affects surface water flow.
- Use a spreadsheet to create graphs of values over time using multiple scales.
- Appreciate an integrated approach to water management at the watershed scale.

Pre-Readings

The Water Cycle

A brief introduction to the water cycle is provided in the pre-reading Lab 09 The Water Cycle, which

includes both the hydrosphere (liquid water) and cryosphere (frozen water). When considering water resources, a more detailed understanding of the processes that occur at the soil surface, the generation of runoff to streams, and infiltration to groundwater is important. The pre-reading Lab 19 Catchments as Systems introduces the catchment, or watershed, as a fundamental landscape unit. Precipitation moves through the watershed either as runoff or interflow to become surface water directly. Or, precipitation may infiltrate down to the water table where the groundwater system begins. Net infiltration (the water that reaches the water table) raises the groundwater level and is stored in the pores spaces in the ground. Groundwater then gradually flows underground to discharge to surface water bodies, where it can provide baseflow to streams year-round.

This series of short videos (Video 20.1, Video 20.2 and Video 20.3) introduces the major terms and concepts:

Video 20.1: The Water Cycle (<https://www.youtube.com/watch?v=al-do-HGuIk>). This video (6:46) introduces all parts of the water cycle, and covers many of the terms used.



One or more interactive elements has been excluded from this version of the text. You can view them online here: <https://pressbooks.bccampus.ca/geoglabmanualv2/?p=280#oembed-1> (#oembed-1)

Video 20.2: What is Groundwater? (https://www.youtube.com/watch?v=oNWAerr_xEE) This video (5:10) is a good introduction to groundwater, and how groundwater interacts with surface water.



One or more interactive elements has been excluded from this version of the text. You can view them online here: <https://pressbooks.bccampus.ca/geoglabmanualv2/?p=280#oembed-2> (#oembed-2)

Video 20.3: Have you drunk Dinosaur Pee? (<https://www.youtube.com/watch?v=KK64DqpIy0s>) This humorous video examines how water can be tracked in the water cycle.



One or more interactive elements has been excluded from this version of the text. You can view them online here: <https://pressbooks.bccampus.ca/geoglabmanualv2/?p=280#oembed-3> (#oembed-3)

Stream Hydrographs

A stream hydrograph presents the amount of water flowing in a stream over time. Become familiar with how streamflow, also known as discharge, is measured and how hydrographs are created by

reading How streamflow is measured (https://www.usgs.gov/special-topic/water-science-school/science/how-streamflow-measured?qt-science_center_objects=0#qt-science_center_objects).

A summary of hydrographs and the impact of different types of watersheds on hydrographs can be found at Interpretation of Hydrographs (<https://www.bbc.co.uk/bitesize/guides/zpqwwmn/revision/1>), pages 1 and 2.

Groundwater, the Water Table, and Groundwater Pumping

A good introductory summary of groundwater can be found in Groundwater and the rural homeowner (https://pubs.usgs.gov/gip/gw_ruralhomeowner/) from the United States Geological Survey. Read from the beginning to the end of the **Increased Pumping in the Immediate Area** section (pages 5-18). Read from **Quality of Water** onwards just for interest sake if you wish. For a local perspective on groundwater, watch Video 20.4.

Video 20.4: It's called groundwater! (<https://www.youtube.com/watch?v=VtIY4FYWJV8>) This video introduces groundwater in British Columbia and how it is monitored.



One or more interactive elements has been excluded from this version of the text. You can view them online here: <https://pressbooks.bccampus.ca/geoglabmanualv2/?p=280#oembed-4> (#oembed-4)

Hydrology Jargon

The three preceding pre-readings introduce a wide range of terms that describe the water cycle, streamflow and its measurement, and groundwater. You will need to become familiar with the following terms to complete this lab:

Precipitation: The total amount of water deposited on the ground surface from the atmosphere.

Rainfall: The proportion of total precipitation that reaches the ground as liquid water.

Snowfall: The proportion of total precipitation that falls as frozen water (snow, sleet, ice).

Watershed: An area of land drained by a stream system, or other body of surface water.

Runoff: Water that flows laterally above the soil surface.

Interflow: Water that flows laterally in the unsaturated soil zone towards a surface water body.

Net infiltration: Water that flows downwards from the soil zone to become part of the groundwater system.

Water table: The location where soil pores become saturated with water. The water table separates the unsaturated soil zone (above) from the groundwater (below).

Groundwater: Water held or flowing underground through pores or fractures between mineral grains that are fully saturated with water.

Streamflow: A general term for water flowing in a creek, stream or river.

Discharge: The volume of water flowing in a creek, stream or river, commonly measured in cubic metres a second (m^3/s ; also called cumecs).

Peak discharge: The highest value of stream discharge for a particular time range.

Lag time: The difference in time between a first event, and a second event. For example, the time between the peak of a rainfall event, and the peak of measured stream discharge.

Baseflow: The water flowing in a stream when there has been no recent precipitation. Baseflow is largely supplied by groundwater flowing into the stream, or glacial melt.

Hydrograph: A graphical presentation of stream discharge against time.

Aquifer: a region of saturated geological materials from which groundwater can be pumped out easily.

Groundwater level: the elevation of groundwater inside a groundwater well.

Groundwater pumping: the removal of groundwater from a groundwater well using a pump.

Water as a Resource – Human Alteration of the Water Cycle

Surface water features within watersheds can be altered by land use within the watershed. All water use within a watershed affects the water cycle. The impacts may show up as changes to stream discharge, groundwater levels and/or on the overall nature of the water balance in the watershed.

On the input side of the water balance, precipitation is the main input of water to a watershed, and land use type can affect how much precipitation ends up as runoff, and how much water ends up infiltrating into the ground to become groundwater. Sophisticated analysis may be required to determine any effects of human alteration of the watershed on the stream discharge.

The output side of a water balance is also affected. Humans may extract water from surface water or groundwater to provide domestic water supply (a single household), to supply drinking water (a water utility supplying many houses), to provide irrigation water, or for commercial purposes. This water may be returned to places within the watershed after it has been used (for example, some domestic water use is collected, treated, and discharged back to surface water), or water volume may be lost from the watershed if the water is evapotranspired by plants back to the atmosphere through use of the water for agricultural irrigation or for watering household lawns and gardens.

The timing and scale of effects depends on the timing and scale of alteration. Drinking water usage tends to be consistent year round, except where populations are highly seasonal. Irrigation water usage peaks in summer time when crops are growing. Commercial/industrial uses can vary over the year, depending on the type of production. Water extracted directly from a surface water feature will immediately reduce the stream discharge or water level in that feature. Water extracted from

groundwater either intercepts groundwater that was on its way to discharging to surface water as groundwater baseflow, or, the groundwater pumping may lower the water level enough to cause water to flow out of surface water and into the groundwater. Both effects reduce the amount of surface water flow.

British Columbia Water Data Sources

Data for water resources in British Columbia (BC) are collected by a variety of different organizations:

- Environment and Climate Change Canada is the federal government ministry that looks after weather and climate stations;
- Water Survey of Canada (part of ECCC) maintain Canada's network of stream discharge measuring stations and prepare hydrographs; and
- BC Ministry of the Environment collects groundwater data.

The BC Government has created a web-based portal, the BC Water Tool (<https://www.bcwatertool.ca/>), to allow the public to easily access all of the water-related data in a convenient place.

Functions in the BC Water Tool

At the top left hand side of the BC Water Tool (<https://www.bcwatertool.ca/>) screen, there is a series of buttons that you can click to change the way data is presented on the screen:

- The **+** and **–** buttons allow the screen to be zoomed in and out.
- The **hand icon** allows you to use a mouse to drag the screen to new locations.
- The **disk icon** below the +/- allows you to save your current view as a url, or to download the data on the screen to a file.
- The folded paper icon allows you to change the map style (really, the basemap). **Default** is likely the best scheme to use to see all the drainage features. You will also find **Satellite**. Click on this view, and the simplified map will be replaced with a detailed colour satellite image. Try out some of the different view types.
- The **i** (for information) icon provides access to the map legend.

As you navigate around the map, you may also <right click> using a mouse at any location. A small dialogue box will open on the screen with the title **Coordinates**. The box contains the latitude and longitude of the location clicked expressed in decimal degrees.

Further to the left are a second series of buttons arranged vertically. Click on each button in turn, and see how the data presented on the screen changes. From top to bottom, the buttons are

- **Book icon**: watershed reporting;
- **Upwards trending graph icon**: surface water hydrometric stations;
- **S**: surface water quality measurement stations;

- **G:** groundwater quality monitoring stations;
- **Downward trending graph icon:** groundwater level monitoring stations; and
- **Cloud icon:** climate stations.

On each different data screen, different markers are used to indicate currently active stations, and inactive stations for which there is historical data, but not current data. Click on **i** (for information) and the legend will display.

Graphing Using a Spreadsheet

The lab requires that you be able to download data on precipitation, stream discharge and groundwater levels from different BC and Federal government sources. The data will be collected together in a spreadsheet, and then graphed over time. You should be familiar with spreadsheets and how to open a file, copy and paste data, save a spreadsheet, and plot data as an x-y graph of a value plotted over time. Please complete the spreadsheet tutorial (Tutorials 1, 2, 6, 7, and 8) if you require a review.

Lab Exercises

This lab examines the ground-based components of the water cycle at the scale of a watershed. It is based on the watershed of the Nicomekl River near Langley, British Columbia, located to the east of Vancouver in the Fraser Valley. In this lab you will:

- Examine the geography of the watershed.
- Download precipitation, stream flow and groundwater level data.
- Analyse daily and annual patterns in this data.
- Plot the data in a spreadsheet.
- Consider the effects of water resource use on a watershed.

It is estimated that the lab will take 2-4 hours to complete. Submit your answers as directed by your instructor.

EX1: Exploring the Watershed Area

In this exercise, you will use the BC Water Tool (<https://www.bcwatertool.ca/>) to examine the overall geography of the watershed.

Step 1: Open the BC Water Tool (<https://www.bcwatertool.ca/>) website, and navigate to the Water Portal for the South and Coast Area (link near the top of the home page). You may have to accept a data license agreement.

Step 2: Zoom the map into the area of Vancouver, and to the Fraser Valley located to the east, and locate the sub-area outlined in Figure 20.1.

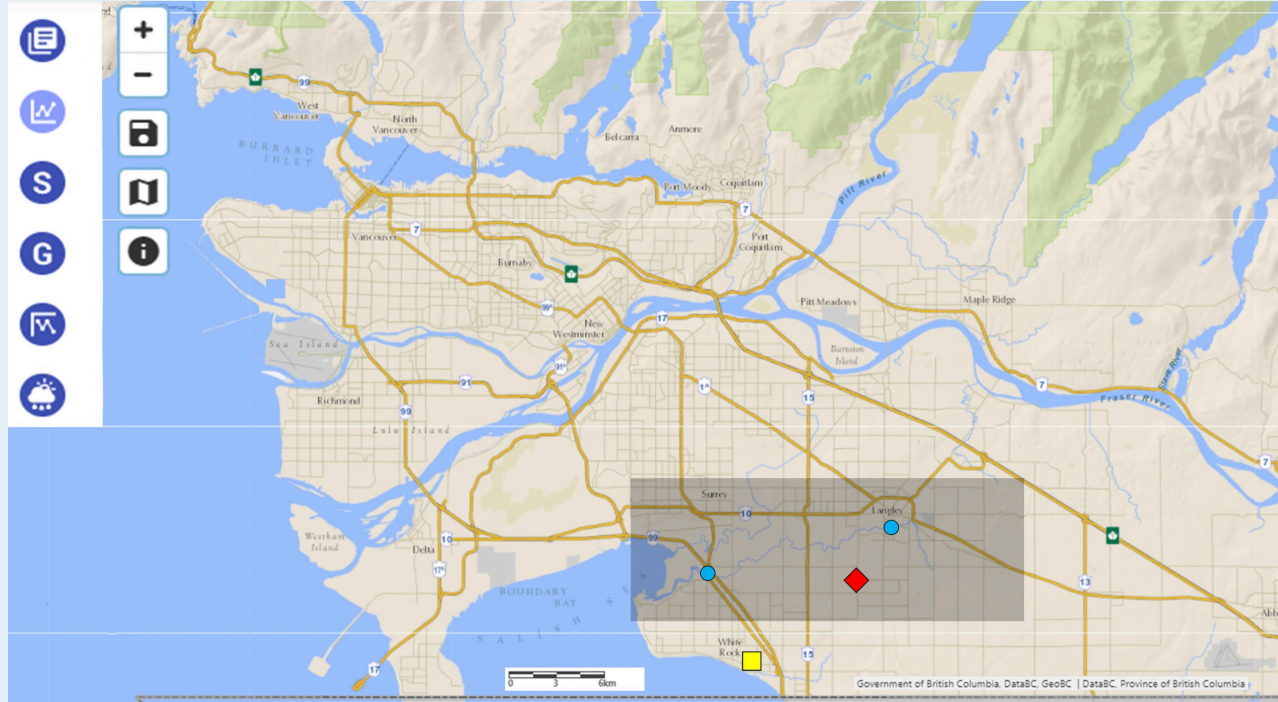


Figure 20.1. General location map of the watershed of the Nicomekl River located just east of the City of Vancouver, British Columbia. Markers indicate the location of a climate station (yellow square; White Rock Station: 1108910), a hydrometric station close to the river discharge to the sea (blue circle on left; Nicomekl River Upstream of Sea Dam – City of Surrey 08MH0020), a hydrometric station (blue circle on right; Nicomekl River At 203 Street, Langley 08MH155) and the location of groundwater level monitoring wells (red diamond; Langley Observation well 353 – 196 St near 36 Ave). Source: Location of Nicomekl River Watershed adapted by C. Nichol contains mapping information from © DataBC (<https://data.gov.bc.ca/>) licensed under an All Rights Reserved license (<https://choosealicense.com/no-license/>). Permission for use provided by the Province of British Columbia.

Step 3: Take 15 minutes and explore the Nicomekl River watershed using the BC Water Tool. You may wish to alternate your map view between the default line map view, and the satellite view. You can click on the **i** information icon to activate the map legend display. You may find that the top book icon (watershed reporting) does not work in this area.

Step 4: (Optional) If you are familiar with Google Earth (Web) (<https://earth.google.com/web/>), you may also wish to explore the watershed using this program.

Step 5: Locate the Nicomekl River at the point where it flows east to west to the ocean at the hydrograph station to the left of Figure 20.1 (49.06917N or 49 04' 09"N; 122.82500W or 122 49' 30"W). Starting from this point, trace the river to the east where it passes through the City of Langley to the hydrograph station to the right of Figure 18.1 (49.10417N or 49 06' 15" N; 122.6603W or 122 39' 37" W). Further to the east, the river may become difficult to trace.

Step 6: Examine some of the major tributaries of the Nicomekl as well. The Nicomekl has two side creeks that branch off to the south of the river – Anderson Creek just west of Langley, and another the branches off southeast of Langley.

Once you have taken some time to explore the watershed, use the BC Water Tool (<https://www.bcwatertool.ca/>) answer the following questions in 3-5 sentences each:

1. Using the **Default** map style and the **Satellite** map style, describe the land use within the watershed and estimate the approximate proportions (%) of the land within the Nicomekl watershed that are covered by farmland, urban land, and natural land.
2. Examine the character of the side creeks from the Nicomekl River on the south side of the river in the area of Highway 15 (from 168th to 164th St) in the **Default** map style, and compare to the **Satellite** map style. Describe the dominant land use and how it impacts the drainage pattern.
3. Examine the area of Langley city center (approx. 49.104, -122.657; the intersection of Glover Road or 203rd Street and the Fraser Highway). The urban area is bounded on the north by the Langley Bypass of Highway 10, on the south by the Nicomekl. On the west by 192nd Street and on the east by 208th Street and the Langley Bypass. There appear to be creeks branching off the Nicomekl river to the south and east. Describe how the channel patterns on the north side of the main Nicomekl channel differ compared to the south. Viewing both **Default** map style and **Satellite** map style, explain why.

EX2: Annual Precipitation, Stream Discharge and Groundwater Level Data

In this exercise, we will visit a series of data sources using the BC Water Tool (<https://www.bcwatertool.ca/>) to visually examine graphs of climate and precipitation, stream discharge in the Nicomekl, and groundwater levels. You will note important features of the annual changes in each graph, then compare those to monthly average data prepared for you.

You will also download raw data in spreadsheet form. You will use this data in EX3. In each case, save the gathered data to a folder in a known location. If you find that you are unable to complete this step, contact your instructor, who will have a set of data downloaded that you can use.

Precipitation and Climate Data

Step 1: Click on the **Cloud icon** on the left of the screen to show climate stations. Click on the information icon (**i**) to see the legend for active and historical stations.

Step 2: Zoom out until you locate the closest active climate station. It is located south of the watershed close to the United States border in White Rock BC.

Step 3: Click on the station on the map and information will load on the right of the screen for **White Rock station 1108910**. Click **DOWNLOAD DATA** (large button also on the right of the screen) to download the data from this station. Save the file using the name suggested (**station-data-12418.csv**) to a folder you can find.

Step 4: On the bottom right of the screen, you will see panels indicating graphs for **Temperature**, **Precipitation**, and **Snow on Ground**. Depending on the size of your screen, you may need to scroll down to see these.

Step 5: Click on the panel for **Precipitation**. You should now see a graphic displaying precipitation such as the one shown in Figure 20.2. The graphic has the following features:

- Precipitation amount is plotted on the y-axis and date is plotted on the x-axis.

- The black horizontal line in each month indicates the median value in that month.
- Dark shading indicates the more common historical ranges of data in that month of the year.
- Light grey shading indicates the more extreme variations in historical data.
- Blue graphs show the cumulative amount of precipitation for each month in the current year.

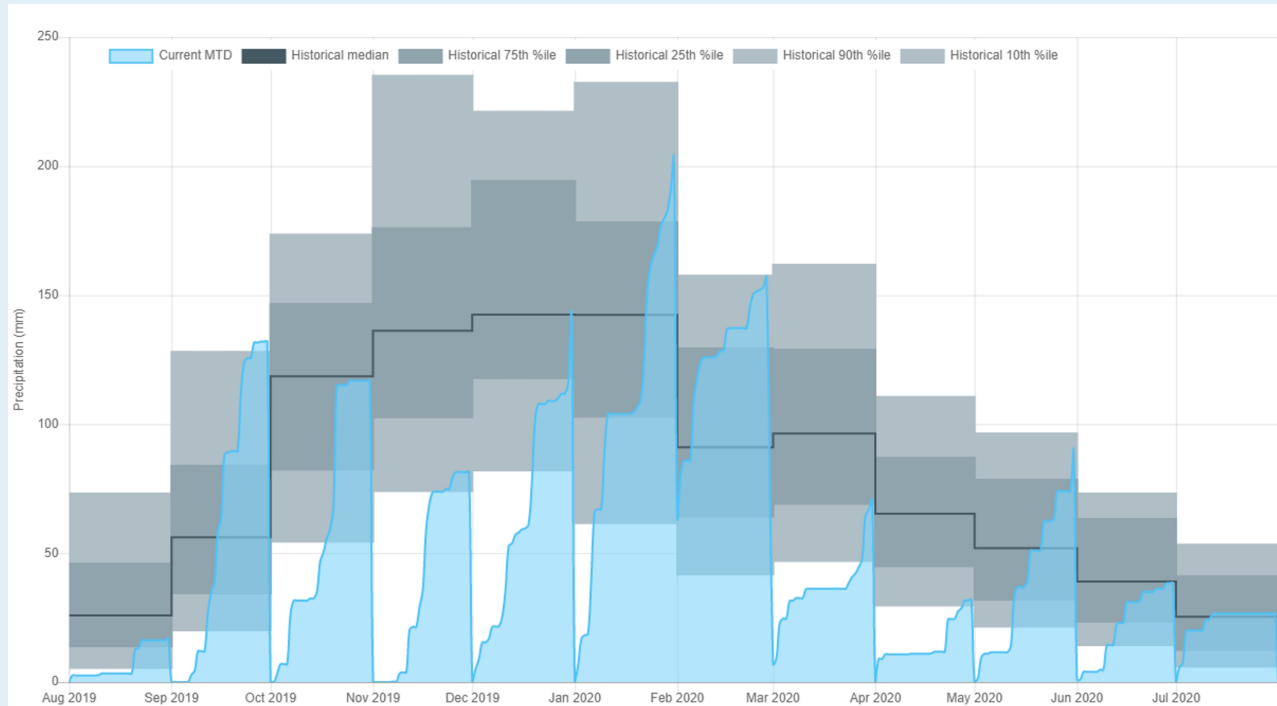


Figure 20.2. Example of Precipitation data from the White Rock climate station. Source: Precipitation data from White Rock climate station 1108910 © BC Water Tool (<https://www.bcwatertool.ca/>) contains precipitation data licensed under the Environment and Climate Change Canada Data License (https://climate.weather.gc.ca/prods_servs/attachment1_e.html). [Image descriptions]

Visually trace the black line across the figure. Write down which two months have the highest precipitation and which two months have the lowest precipitation.

Step 6: To exit this screen, click on the **X** located in the top right of the screen.

Hydrograph Data

Step 1: Click on the **upwards trending graph icon** to activate the display of the locations of hydrographic stations.

Step 2: Locate the active hydrograph station located near the center of Langley (Nicomekl River At 203 Street, Langley, 08MH155, 49 06' 15" N, 122 39' 37" W).

Step 3: On the right of the screen, click **DOWNLOAD DATA** and save the file (station-data-4268.csv) to your folder.

Step 4: On the right of the screen, click on **7 Day Flow**. You will see a graph similar to Figure 20.3. The stream discharge is plotted on the y-axis in m^3/s . The date is plotted on the x-axis. Statistical features are as per Figure 20.2. As you move the cursor across the screen, the values of the median value of discharge on that day, and the range over time, will be displayed. The orange (may appear yellow) line shows the actual discharge over the last 1 year period and is labelled **Current**.

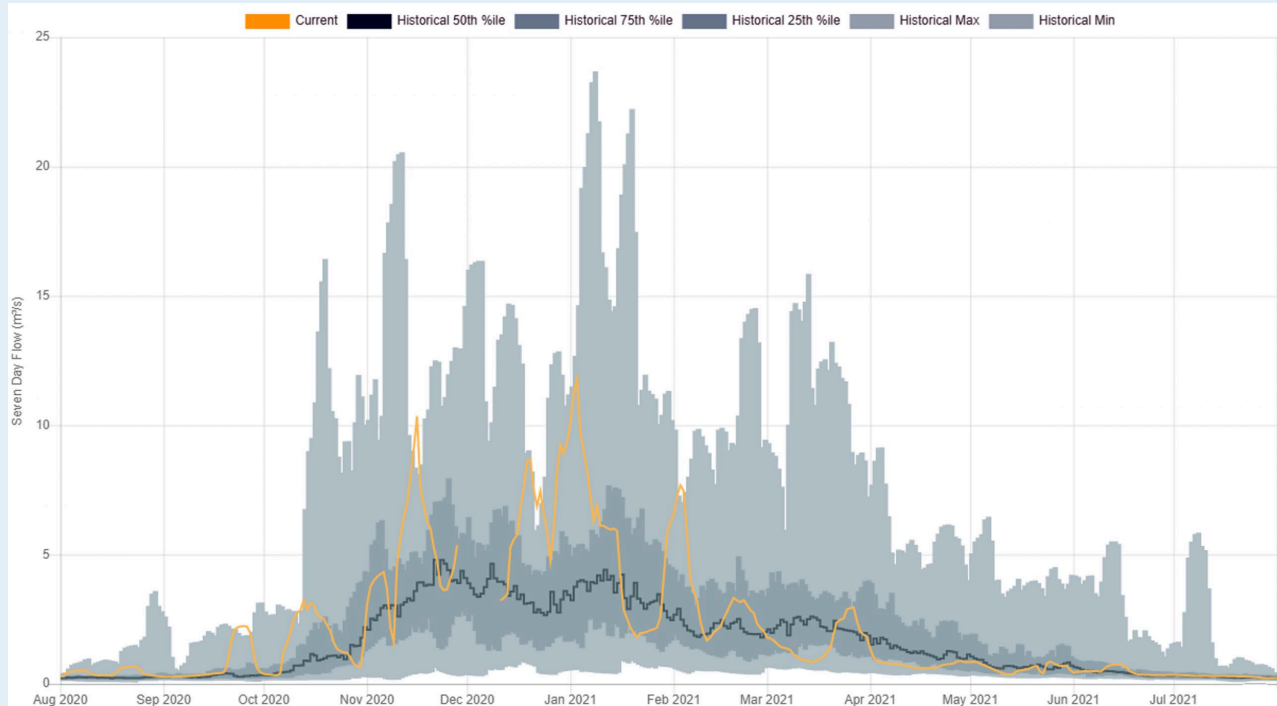


Figure 20.3. Example of stream hydrograph from the Nicomekl River hydrograph 08MH155 station. Source: Stream discharge in Nicomekl River at Station 08MH155 © BC Water Tool (<https://www.bcwatertool.ca/>) contains stream discharge data licensed under Environment Canada (<https://www.canada.ca/en/transparency/terms.html>) / Water Survey of Canada (https://wateroffice.ec.gc.ca/disclaimer_info_e.html).

Visually trace the black line across the figure. In this case, the black line marks the daily average, with the range for that day shown in grey. Examine the data and write down which two months have, on average, higher discharge, and which two months have the lowest discharge. You will have to use your judgement to translate the daily data to determine the months with highest flow. Follow the orange line across the graphic, and look at how discharge over the last year has changed.

Step 5: To exit this screen, click on the **X** located in the top right of the screen.

Groundwater Data

Step 1: Click on the **downward trending graph icon** to active groundwater level monitoring stations. You may need to zoom out.

Step 2: Locate the two groundwater monitoring well locations to the south of Langley close to Anderson Creek (red diamond in Figure 20.1).

Step 3: Zoom in, and locate the eastern (on the right) of the two wells at this location (Langley 196 St near 36 Ave, Observation Well #353). Click on this well, and then click **DOWNLOAD DATA** and save the data to your folder (station-data-8309.csv).

Step 4: Click on the **Level** button on the right. You will see a graph similar to Figure 20.4. Notice that the groundwater data is plotted as depth to water on the y-axis, but it has been plotted as increasing downwards. This is how water levels are measured in groundwater wells, using a specialized tape measure to record the depth to water downwards from the ground surface. A large depth to water therefore means a lower water elevation. Statistical features are as per Figure 20.2.

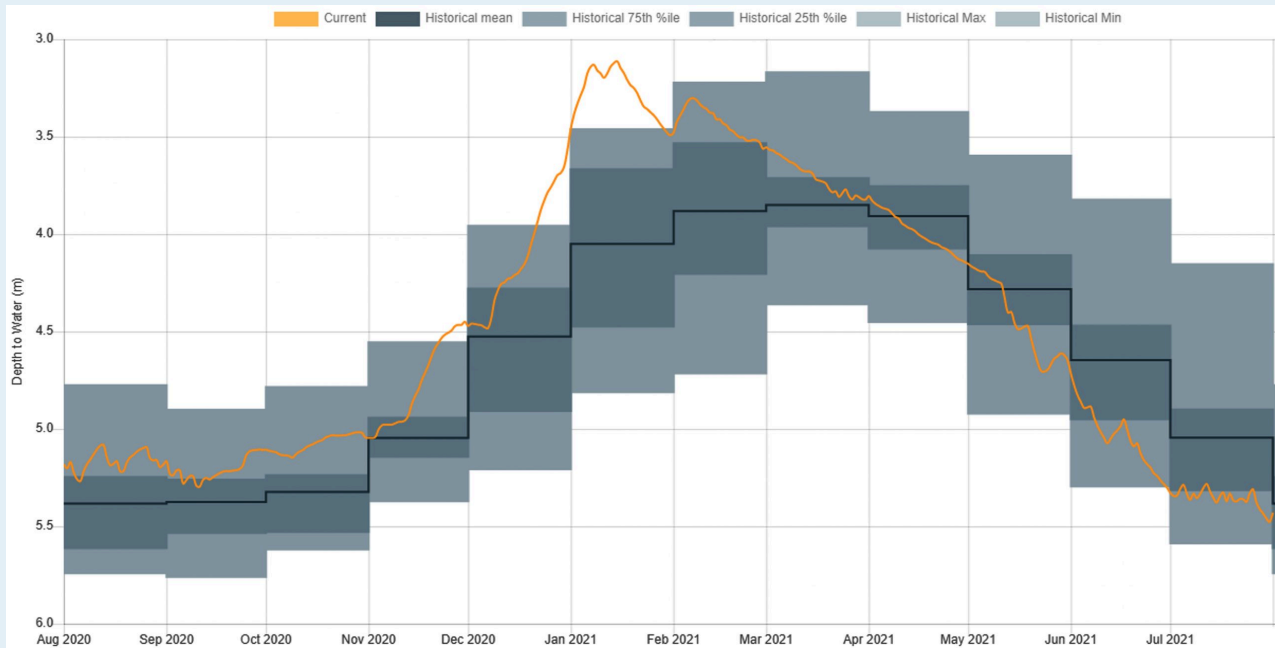


Figure 20.4. Example of groundwater level annual summary graph for Observation well #353. Source: Groundwater levels at BC Obs Well 353 © BC Water Tool (<https://www.bcwatertool.ca/>) contains groundwater level data licensed under the Environment Canada (<https://www.canada.ca/en/transparency/terms.html>) / Water Survey of Canada (https://wateroffice.ec.gc.ca/disclaimer_info_e.html).

Trace the black line across the figure. Write down which two months have, on average, higher groundwater levels (small depth to water) and which two months have lower groundwater levels (large depth to water). If you click on a point on the interactive figure, the values for the month will be displayed.

Step 5: To exit this screen, click on the **X** located in the top right of the screen.

4. Confirm that you have a folder containing three data files in .csv format, one each for precipitation, discharge and groundwater level.

Examining Data on an Annual Basis

Now it is time to examine how water moves in and out of a watershed on an annual basis. The precipitation and groundwater level graphics were done on monthly basis, but flow was on a daily basis. To assist you, your instructor has calculated flow data on a monthly basis. Obtain the set of mean monthly data covering the calendar year prior to your lab from your instructor. Examine the data and answer the following questions:

5. Examine the annual pattern of rainfall data. Which two months represent the peak inputs of water to the watershed from precipitation? In which month(s) are precipitation inputs the lowest?
6. Which two months represent the peak stream discharge out of the watershed? In which month(s) is discharge the lowest? Earlier, you visually assessed the raw stream discharge data to identify your estimates of the high and low flow months. Did your choices from the graphs of discharge match the calculated averages data?
7. Which two months represent the peak groundwater elevation? Which month(s) have the lowest elevation? **Note:** the data record depth from surface; the largest depth to groundwater indicates the lowest groundwater level.

8. How much does the groundwater level change over a year (in m)? What does this water level change represent?
9. What is the lag time between peak precipitation and peak discharge? What is the lag time between peak precipitation and peak groundwater level? Explain what is happening.

EX3: Daily Precipitation, Stream Discharge and Groundwater Level Data

In this exercise you will examine the response time between precipitation, stream discharge, and groundwater level on a daily basis to gain an understanding of how quickly discharge responds to runoff and interflow compared to groundwater flow.

Step 1: Download the EX3 spreadsheet from Worksheets and open it. Here you will note that the station data for precipitation, discharge, and groundwater level have been provided from 2004-09-10 to 2020-12-31. You will also note two graphs. First, a graph of precipitation and discharge for the 2019/2020 water year (October 1, 2019 to September 30, 2020) on a single graph, plotting precipitation as a column, and discharge as a XY type joined by a line. An example is shown on Figure 20.5.

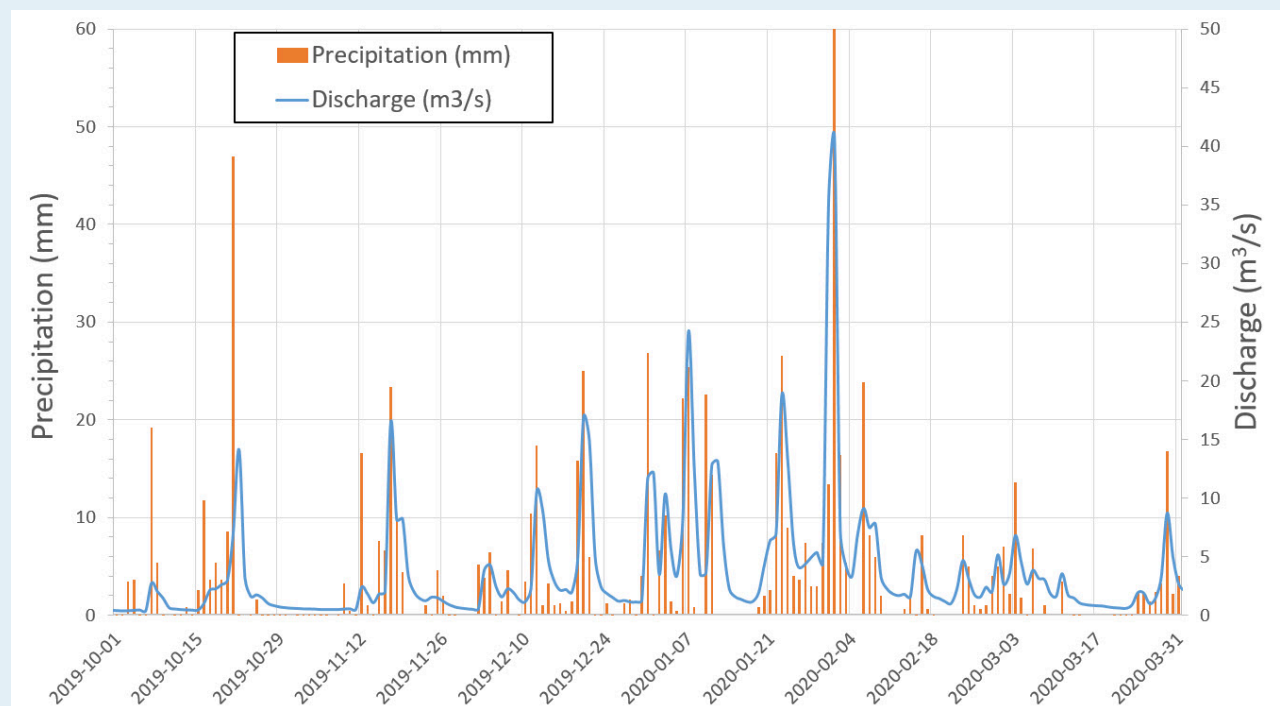


Figure 20.5. Example graph of precipitation and discharge (Data from 2019 and 2020). Precipitation is plotted as a yellow-gold column chart. Discharge is plotted as a solid blue line. Source: Precipitation and discharge in the Nicomekl watershed © C. Nichol contains precipitation data licensed under the Environment and Climate Change Canada Data License (https://climate.weather.gc.ca/prods_servs/attachment1_e.html) and discharge data licensed under Environment Canada (<https://www.canada.ca/en/transparency/terms.html>) / Water Survey of Canada (https://wateroffice.ec.gc.ca/disclaimer_info_e.html).

Second, you will see a graph of precipitation and groundwater level for the 2019/2020 water year on a single graph, plotting precipitation as a column, and groundwater level as an X-Y scatter plot joined by a line. An example is shown on Figure 20.6.

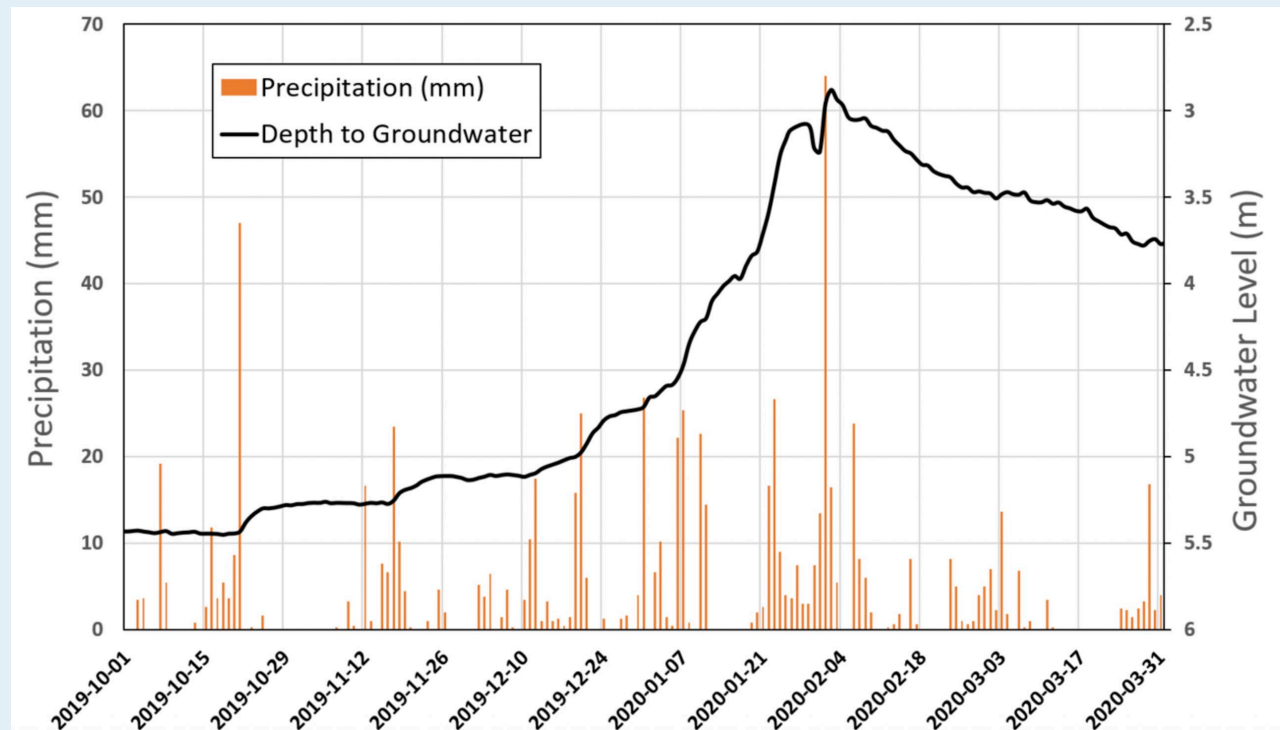


Figure 20.6. Example data set of precipitation and groundwater level. Precipitation is plotted as a yellow-gold column chart. Depth to groundwater is plotted as a solid black line. Source: Precipitation and groundwater level in the Nicomekl watershed © C. Nichol contains precipitation data licensed under the Environment and Climate Change Canada Data License (https://climate.weather.gc.ca/prods_servs/attachment1_e.html) and discharge data licensed under Environment Canada (<https://www.canada.ca/en/transparency/terms.html>) / Water Survey of Canada (https://wateroffice.ec.gc.ca/disclaimer_info_e.html).

Step 2: Open your file for climate data (**Station-data-12418.csv**) by double clicking on the file. You may need to start your spreadsheet program first, and then use **File > Open** to open the file. This file contains precipitation data, then snowfall data, and then a number of temperature data. You only need the precipitation data, and can delete everything after the precipitation data if you wish. Scroll down the data until you see the data for Jan 1, 2021 onwards. Copy and paste this data into the **Precipitation Data** portion of your EX3 spreadsheet.

Step 3: Open the file for hydrometric data (**Station-data-4268.csv**). This file contains both discharge and water level data. You only need the discharge data, and can delete the water level data if you wish. Copy and paste the discharge data from Jan 1, 2021 onwards into the **Streamflow Data** portion of your EX3 spreadsheet.

Step 4: Open the file for groundwater level data (**Station-data-8309.csv**). Copy and paste the water level data from Jan 1, 2021 onwards into the **Groundwater Level Data** portion of your EX3 spreadsheet.

Answer the following questions, and submit all graphs as directed by your instructor:

- Examine the data that you just copied into the spreadsheet. Are there any problems with this raw data set in either precipitation, stream discharge or groundwater level? What do you think may have happened?

11. The two graphs show Oct 2019 to Sept 2020 as default. If needed, adjust the date range displayed on these graphs to the date range specified by your instructor. Copy/screenshot/snip these two graphs and save to a known location.
12. What time lag typically occurs between larger rainfall events in the winter, and changes in discharge in the Nicomekl River? You may wish to note some larger rainfall events on an annual graph, and adjust the x-axis so that you can zoom in on those dates only. Choose one such event that supports your answer and describe.
13. Examine the graph plotting precipitation and groundwater level data. Does the groundwater level respond to precipitation on a daily basis? Discuss the relationship between precipitation and groundwater level change and the associated lag times. Choose a range of data on the graph of precipitation and groundwater level that supports your conclusion.
14. Groundwater levels rise and fall on a seasonal basis. What happens to the water stored in groundwater between September and February?

EX4: Water Users in the Watershed

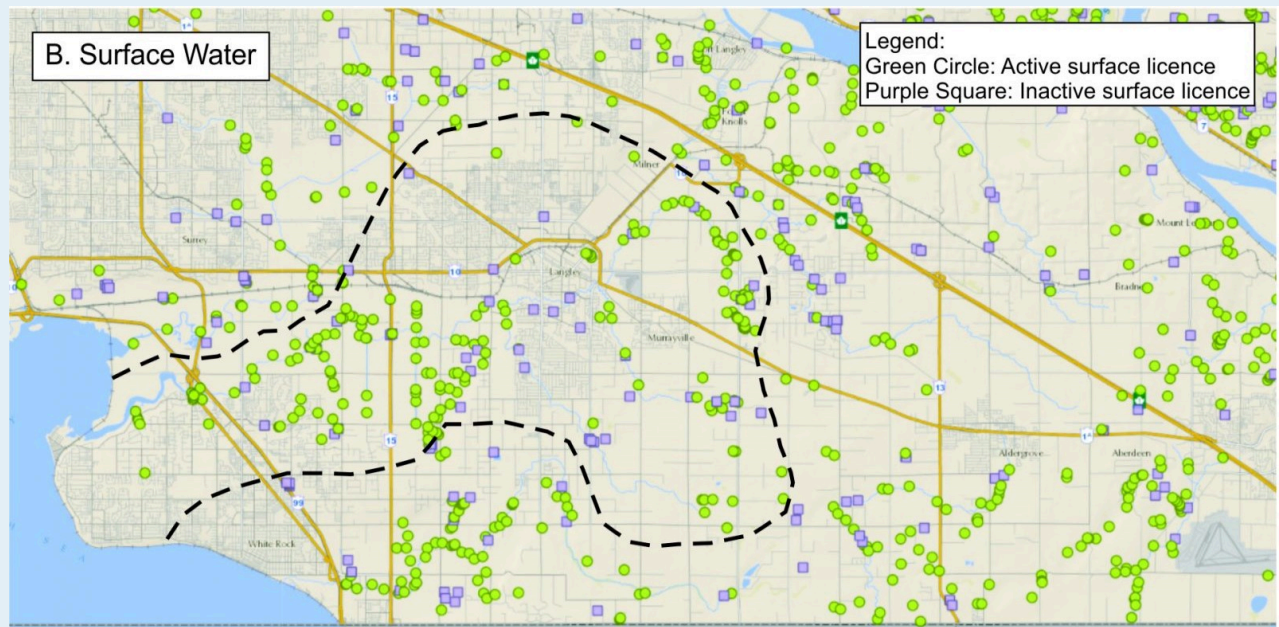
In this exercise, you will examine some of the water users within this watershed, and consider what affect their usage has on the stream discharge, and upon the overall nature of the water balance in the watershed. In other words, you will be introduced to the complexity of water management in BC.

The hydrograph and groundwater levels within the Nicomekl River watershed are affected by the use of water by humans living within the watershed. Here, drinking water usage is consistent year-round, irrigation water usage peaks in summer time, and commercial use varies throughout the year.

Figure 20.7 indicates the approximate area of the Nicomekl River watershed (Figure 20.7a) and the locations of licensed surface water (Figure 20.7b) and groundwater (Figure 20.7c) water users within the watershed.

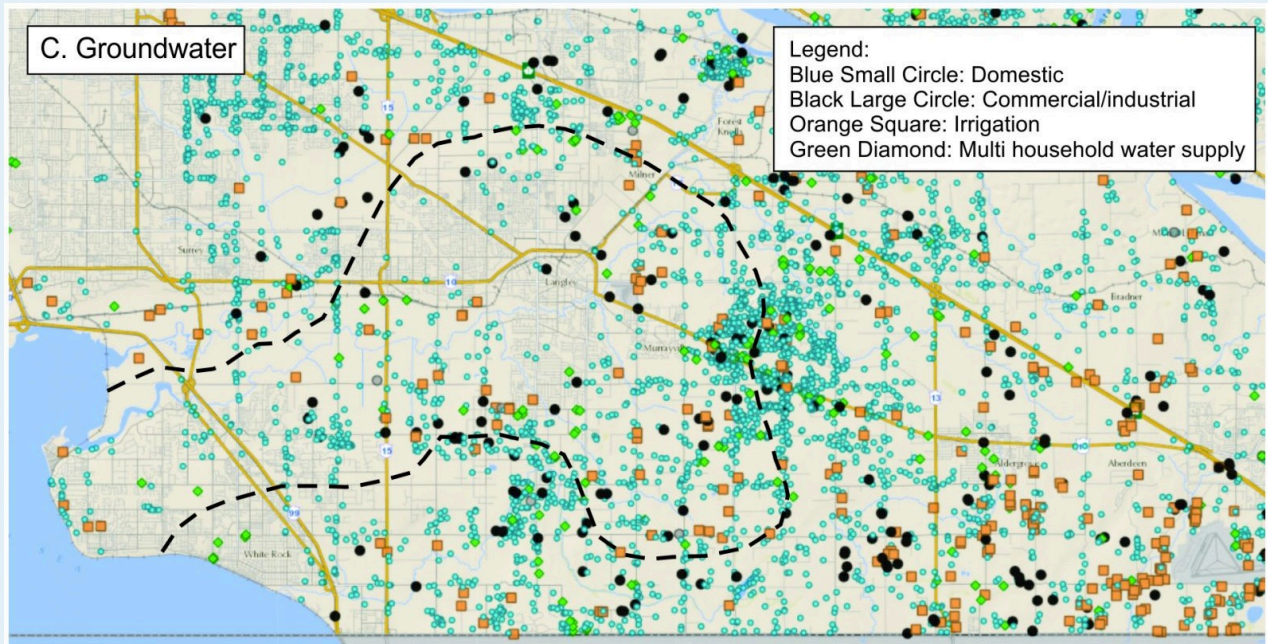


Figure 20.7a. Water usage within the Nicomekl River watershed: A) Watershed boundary indicated by a black dashed line. Source: Water usage within the Nicomekl watershed adapted by C. Nichol contains mapping information from © DataBC (<https://catalogue.data.gov.bc.ca/>). Permission for use provided by the Province of British Columbia. [Click to view image full size]



(<https://pressbooks.bccampus.ca/geoglabmanualv2/wp-content/uploads/sites/1340/2020/07/Lab-20-Figure-7-V5b.jpg>)

Figure 20.7b. Surface water use. Green circles indicate the locations of active surface water licences. Purple squares indicate the locations of inactive surface water licences. Source: Water usage within the Nicomekl watershed adapted by C. Nichol contains mapping information from © DataBC (<https://catalogue.data.gov.bc.ca/>). Permission for use provided by the Province of British Columbia. [Click to view image full size]



(<https://pressbooks.bccampus.ca/geoglabmanualv2/wp-content/uploads/sites/1340/2020/07/Lab-20-Figure-7-V5c.jpg>)

Figure 20.7c. Groundwater use. Blue small circles indicate the locations of domestic groundwater licences. Black large circles indicate the locations of commercial/industrial groundwater licences. Orange squares indicate the location of irrigation licences. Green diamonds indicate the locations of multi-household water supply licences. Source: Water usage within the Nicomekl watershed adapted by C. Nichol contains mapping information from © DataBC (<https://catalogue.data.gov.bc.ca/>). Permission for use provided by the Province of British Columbia. [Click to view image full size]

Using Figure 20.7, answer the following questions:

15. Which areas of the watershed use the most surface water? What usage type do you think these water licenses are used for? Are they domestic, water supply, irrigation, commercial? Explain your answer.
16. Which areas of the watershed have single households (domestic use) that rely upon groundwater for their water supply? Explain your answer.
17. Based on the distribution of all of the surface licenses and groundwater wells, can you determine which areas of the watershed have their drinking water supplied from a large water supplier? Explain your answer.
18. Which area of the watershed do you think is the most environmentally sensitive? Why did you pick this area?

Reflection Questions

In the lab exercises, you saw that the lag time between precipitation in a watershed and surface water and groundwater responses vary. Consider the following situation.

Three farmers have asked permission to pump water to irrigate their crops in July and August. One farmer has a pump that removes water directly from the river. The second farmer pumps from a groundwater well located 10 metres from the river. The third farmer pumps from a well located 2000 m from the river. The local fisheries officer is worried about low water flows in the river in late summer and fall because the river provides habitat for salmon and freshwater trout at this time of year.

1. Describe if/how each pumping situation will impact the river and discuss timescale. You may include sketches of your wells indicating directions of water movement if they would help with your explanation.
2. You are tasked with deciding which, if any, farmer should get a water license to extract water. Discuss three types of information you need to consider in making your decision and why.

Worksheets

Back to EX3

EX3: Student Spreadsheet Template:

- Lab 20 Student Spreadsheet Template v2 [EXCEL] (<https://pressbooks.bccampus.ca/geoglabmanualv2/wp-content/uploads/sites/1340/2021/08/Lab-20-Student-Spreadsheet-Template-v2.xlsx>)
- Lab 20 Student Spreadsheet Template v2 [ODS] (https://drive.google.com/file/d/1xO0luqBgyQM2lw5I7ke0i0_M2zUZId0h/view?usp=sharing)

References

Water Science Group. (2018). *How streamflow is measured*. United States Geological Survey. https://www.usgs.gov/special-topic/water-science-school/science/how-streamflow-measured?qt-science_center_objects=0#qt-science_center_objects

Media Attributions

- Water Cycle | How the Hydrologic Cycle Works (<https://www.youtube.com/watch?v=al-do-HGuIk>) by National Science Foundation (<https://www.youtube.com/c/VideosatNSF>) is licensed under a Standard YouTube License.
- What Is Groundwater? (https://www.youtube.com/watch?v=oNWAerr_xEE) by KQED

QUEST (<https://www.youtube.com/c/QuestscienceOrg>) is licensed under a Standard YouTube License.

- Have you drunk DINOSAUR PEE? (<https://www.youtube.com/watch?v=KK64DqpIy0s>) by Cisco Torres and Harrison Dreves, posted by CuriousMinds (<https://www.youtube.com/c/curiousmindschannel>) is licensed under a Standard YouTube License.

Image Descriptions

Figure 20.2. Example of Precipitation data from the White Rock climate station.

Figure 20.2 provides an example graph of precipitation data from the White Rock climate station that was obtained from the BC Water Tool. Data displayed on this graph are the: (a) cumulative amount of precipitation for each month in the current year, (b) historic median, (c) historical 75th percentile, (d) historical 25th percentile, (e) historical 90th percentile, and (f) the historical 10th percentile.

Your instructor will provide you with the time period to use for the relevant lab exercises, so the data will be different than what is provided in this figure.

[Return to Figure 20.2]

Lab 21: Fluvial Geomorphology and Landforms

Katie Burles and Crystal Huscroft

Water in streams is one of the most widespread and important agents of erosion and deposition on Earth. Flowing water has the ability to free rock material, set it in motion, and then transport materials downstream to depositional environments. These stream-related geomorphic processes produce predictable fluvial landforms. While predictable, these landforms are dynamic and routinely shift over time.

This lab activity provides you with satellite views of fluvial landforms around the world through Google Earth (Web) (<https://earth.google.com/web/>). You will demonstrate your understanding of fluvial geomorphology processes and associated landforms by creating an annotated virtual guided fluvial landform tour.

Learning Objectives

After completion of this lab, you will be able to:

- Identify, interpret and sketch fluvial processes and their characteristic landforms using Google Earth imagery.
- Differentiate braided and meandering channel patterns and provide evidence for why they formed.
- Identify locations of erosion and deposition in streams.
- Locate and describe common landforms of meandering streams and floodplains.
- Demonstrate understanding of local base level in streams.
- Calculate stream gradient for different channel patterns.

Pre-Readings

In order to complete this lab, some background information in fluvial geomorphology and associated landforms, finding fluvial landforms in Google Earth (Web) (<https://earth.google.com/web/>), calculating stream gradient, and attribution guidelines for using Google Earth content is required.

Introduction to Fluvial Geomorphology and Landforms

Fluvial processes are erosional and depositional. Understanding of the following key terms is required for this lab:

- Stream discharge
- Stream velocity
- Stream sorting
- Thalweg
- Abrasion
- Aggradation
- Flooding
- Floodplain

Key fluvial landforms that you will learn to identify in this lab are defined in Table 21.1.

Table 21.1. Definitions of key fluvial landforms identified in this lab.

No.	Landform	Description
1	Braided stream	A stream that forms from multiple intertwining channels around sediments in the streambed.
2	Meandering stream	A stream with a single channel with a snake-like (sinuous) pattern.
3	Point bar	An accumulation of sediment that forms along the inside edge of a stream meander. This is a depositional landform.
4	Cut bank	An erosional landform that forms on the outside edge of a meander where stream flow is highest.
5	Neck	Narrow strip of land where two meanders converge due to erosion along two cutbanks. Once the neck shortens the two meanders join. The main flow of water (the thalweg) will abandon the meander and flow across the neck. The existing meander will eventually form an oxbow lake.
6	Cut off	Straight section of channel formed by closure of meander neck and two meanders connecting.
7	Oxbow lake	Lake formed when a meander is cut off from the channel.
8	Meander scar	Oxbow lakes that are now filled with sediment and vegetation.
9	Local base level	The elevation at which streams stop flowing. Local base level can form when a stream is dammed naturally (such as beaver dams or landslides) or artificially by people (such as an artificial lake called a reservoir).
10	Delta	An accumulation of sediment that forms where a stream reaches base level (i.e. river, lake or ocean).
11	Fluvial (alluvial) fan	A gently sloping, broad cone shaped accumulation of water-transported sediment deposited where a stream exits steeper topography and flows onto gentler ground at the base of a mountain range.

Calculating Gradient

Water flows from higher elevation to lower elevation on the Earth's surface. The gradient (slope) of a stream influences not only the channel pattern (braided or meandering) but also its discharge, velocity, depth, width and ability to transport sediment. In order to get a sense of the processes operating on a segment of a stream, and in preparation for fieldwork, stream hydrologists will regularly determine stream gradients.

The gradient or slope of a stream is calculated by the difference in elevation between two points on a stream (**rise**, Δz) divided by the distance between the two points following the channel where water actually flows (**run**, Δx). These two points are labelled as A and A' on Figure 21.1. For this lab, measurements will be collected in Google Earth (Web). When measuring the distance of the stream we must follow the path of the stream and not just a straight line distance (unless the reach of the stream is straight). Rise is commonly measured in metres (m), whereas the run is often a longer distance, and so may be measured in metres or kilometres (km).

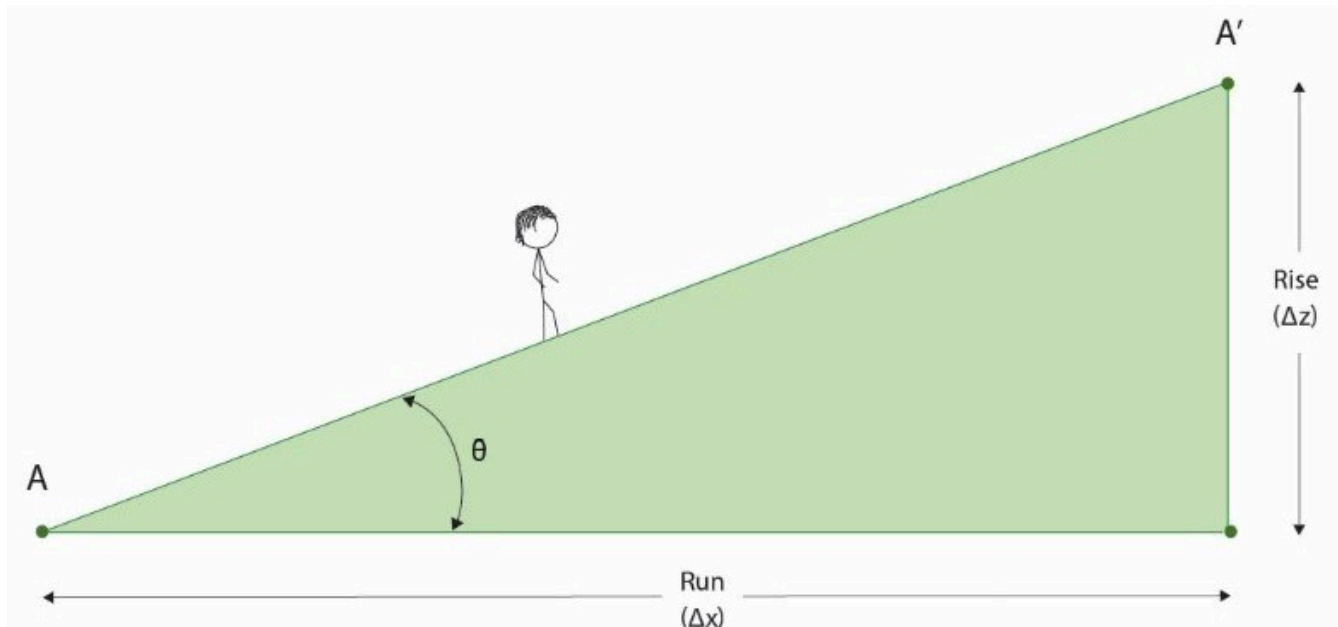


Figure 21.1. Fundamental elements of a slope in a stream. The run (Δx) represents the horizontal distance that is visible in map view between points A and A'. The rise (Δz) represents the vertical distance between points A and A'. Source: Crystal Huscroft, CC BY-NC-SA 4.0.

After obtaining the vertical elevation change (rise, Δz) and the horizontal distance (run, Δx) between two points, stream gradient can be calculated and expressed in three ways:

1. As a percent (%): the fraction (rise \div run) expressed as a percentage (Equation 21.1).

Equation 21.1

$$\text{Gradient}(\%) = \frac{\text{Rise, } \Delta z(m)}{\text{Run, } \Delta x(m)} \times 100\%$$

2. As an angle, θ (degrees) (Equation 21.2):

Equation 21.2

$$\text{Gradient}(\text{°}) = \text{Tan}^{-1} \left(\frac{\text{Rise, } \Delta z(m)}{\text{Run, } \Delta x(m)} \right)$$

3. In elevation change per stream distance (m/km): the gradient expressed with different units used for **rise** and **run**, but with the **run** always reduced to one unit, commonly 1 km (Equation 21.3):

Equation 21.3

$$\text{Gradient}(m/km) = \frac{\text{Rise, } \Delta z(m)}{\text{Run, } \Delta x(km)}$$

For example, let us assume that the elevation change we measured on Google Earth (Web) (<https://earth.google.com/web/>) between points A and A' was 5 m, and the horizontal distance we measured between our upstream and downstream points using Google Earth was 200 m (Figure 21.2).

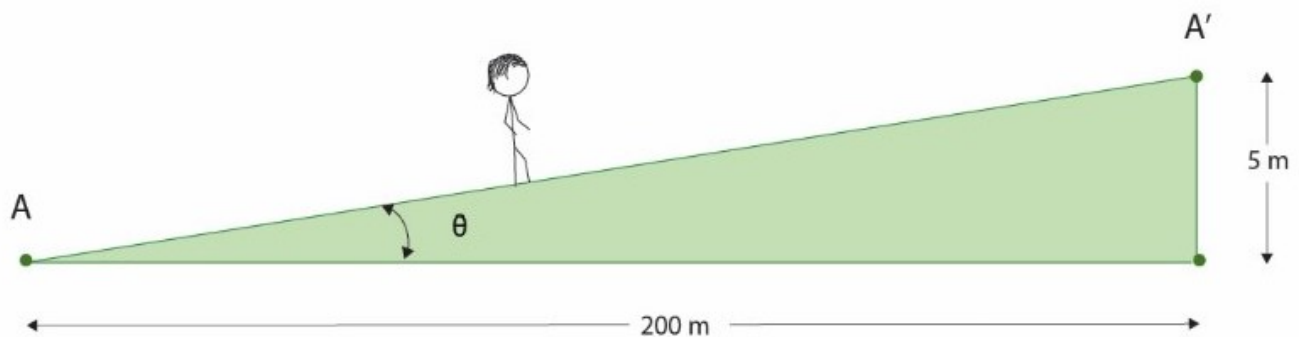


Figure 21.2. Sample values for the fundamental elements of a stream gradient. In this example, the distance along the stream or run (Δx) has a value of 200 m and the difference in elevation or rise (Δz) has a value of 5 m between points A and A'. Source: Crystal Huscroft, CC BY-NC-SA 4.0.

Using the equations presented above, we can express our stream gradient:

1. As a percent (%) (Equation 21.1):

$$\text{Gradient}(\%) = \frac{\text{Rise, } \Delta z(m)}{\text{Run, } \Delta x(m)} \times 100\% = \frac{5 \text{ m}}{200 \text{ m}} \times 100\% = 2.5\%$$

2. As an angle, θ (degrees) (Equation 21.2):

$$\text{Gradient}(\text{°}) = \text{Tan}^{-1} \left(\frac{\text{Rise, } \Delta z(m)}{\text{Run, } \Delta x(m)} \right) = \text{Tan}^{-1} \left(\frac{5 \text{ m}}{200 \text{ m}} \right) = 1.4\text{°}$$

3. In elevation change per slope distance (m/km) (Equation 21.3):

$$\text{Gradient}(m/km) = \frac{\text{Rise, } \Delta z(m)}{\text{Run, } \Delta x(km)} = \frac{5 \text{ m}}{\left(\frac{200 \text{ m}}{1000 \text{ m per km}} \right)} = 25m/km$$

Low-gradient streams are almost flat and have very little slope, whereas high gradient streams indicate a steep slope. Gradient is a key control of stream velocity, which in turn controls sediment erosion and deposition in a stream. Water in a high-gradient stream has a higher velocity, higher ability to erode the Earth surface, and therefore is capable of transporting coarser sediment. In contrast, water in a low-gradient stream has a slower velocity, lower ability to erode the Earth surface, and may only be able to transport fine sediments.

Instructional Tour in Google Earth (Web)

The exercises in this lab require you to identify fluvial landforms in Google Earth (Web) (<https://earth.google.com/web/>) and calculate gradients. Before commencing the lab exercises, complete the Instructional Tour: Fluvial Geomorphology Lab [KML] (https://drive.google.com/file/d/1lDzjEqo_SUwk3yQ2l-VR2crXtxZL9e_Y/view?usp=sharing) to learn more about how to find and draw the fluvial landforms you will include in the virtual guided tour you will produce.

Step 1: Download the KML file Instructional Tour: Fluvial Geomorphology Lab [KML] (https://drive.google.com/file/d/1lDzjEqo_SUwk3yQ2l-VR2crXtxZL9e_Y/view?usp=sharing) to your computer or Google Drive.

Step 2: Open Google Earth (Web) (<https://www.google.com/earth/>). Select **Projects**, create a **New Project** and **Import KML from computer** (or Google Drive, depending on where you saved it).

Step 3: Select **Present**. Take your time to zoom in and out at each location to view the specific examples. Please note there is no audio for this tour.

Alternatively, view this PDF that contains screen captures of the Instructional Tour (https://pressbooks.bccampus.ca/geoglabmanualv2/wp-content/uploads/sites/1340/2020/07/PDFSupplement_InstructionalTour_FluvialGeomorphologyLab_v2_08Jun21.pdf).

Attribution Guidelines for Using Google Earth Content

All users of Google Earth content must follow specific attribution guidelines (<https://www.google.com/permissions/geoguidelines/attr-guide/>). Students submitting screen captures of all stops on the virtual tour created in EX1 must therefore follow attribution guidelines for using Google Earth (Web) (<https://earth.google.com/web/>) content.

Screen captures must include the Google logo and third-party data providers in the imagery (Figure 21.3). This attribution information is shown on the bottom of the screen. The size of the attribution text must be readable for the screen capture.

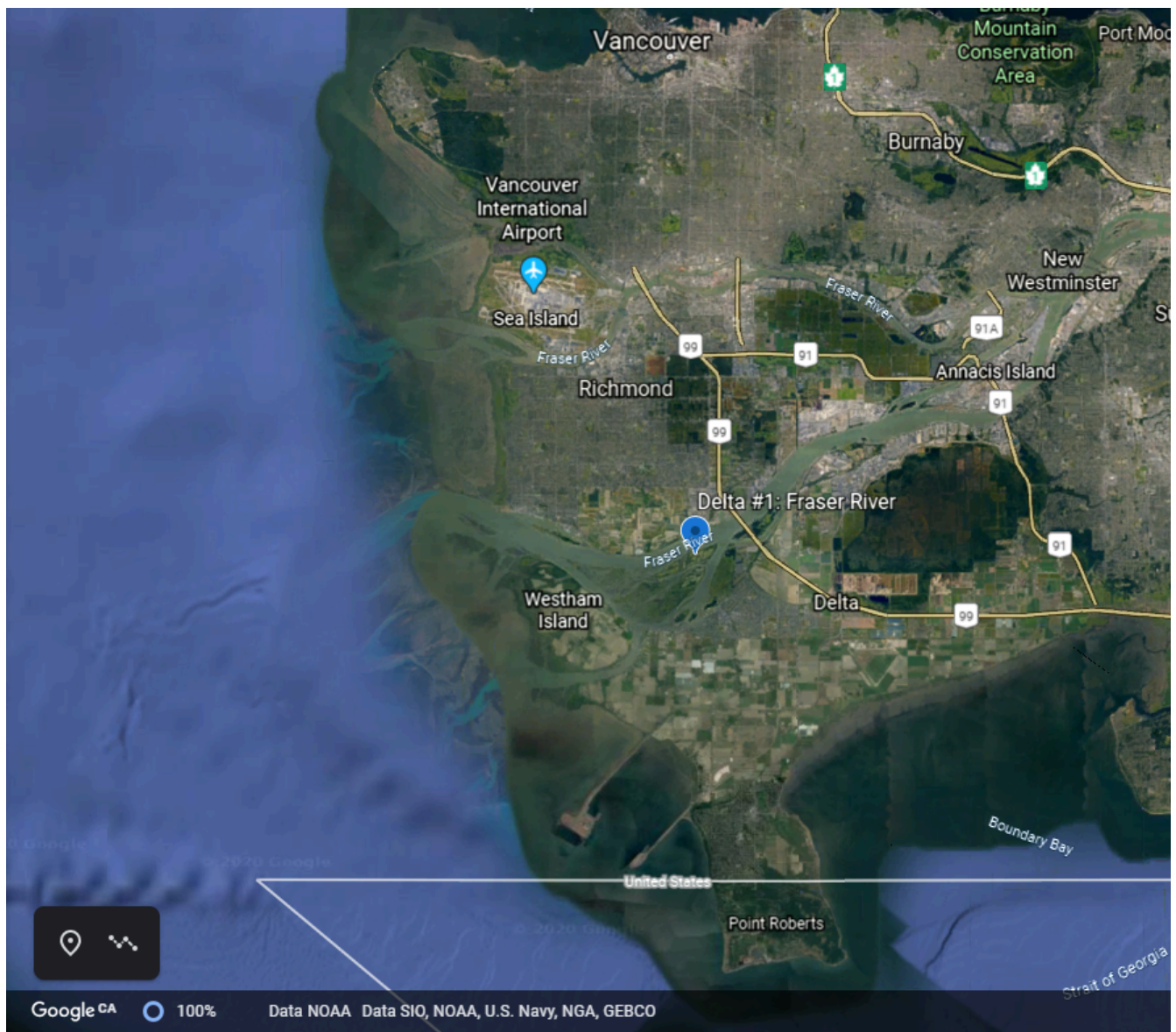


Figure 21.3. Google Earth screen capture, including Google logo and third-party data providers. Used in accordance with Google Earth terms and conditions.

Lab Exercises

This lab includes two exercises that result in creating an assignment to be handed in as a report in PDF format. The submitted report will include a series of required figures with captions.

- In EX1 you will create a virtual guided fluvial landform tour in Google Earth (Web) (<https://earth.google.com/web/>).
- In EX2 you will calculate stream gradient for two different streams included in EX1 and include these calculations as stops on your tour.

This lab assignment will take 3 hours to complete. The length of time will depend on familiarity using

Google Earth (Web) (<https://earth.google.com/web/>), background understanding of fluvial landforms, and experience calculating gradients.

EX1: Create a Guided Fluvial Landform Tour

Create a virtual fluvial landform tour in Google Earth (Web) (<https://earth.google.com/web/>) that includes:

1. Eleven (11) fluvial landforms in chronological order (refer to Table 21.2). Each landform will be a stop on the tour, and
2. A detailed description of how each landform formed with clear evidence and observations. Consider any human interference or land use near the landform.

Some background research may be required to find good locations of various fluvial landforms. Locations **must not** replicate examples in the Instructional Tour.

Step 1: Create Project

Open Google Earth (Web) (<https://www.google.com/earth/>). From the **Projects** menu on the left of the screen, select **New Project**. In the drop-down options, select **Create KML file**. Click on the pencil icon to edit the title to include your last name, then first name, student number, and lab number (e.g., **Doe Ximena c0453993 L19**). The **Project** will be the basis of the Guided Fluvial Landform Tour.

Step 2: Familiarize Yourself With Google Earth (Web)

In particular, learn to:

- Navigate in Google Earth (Web) (<https://www.google.com/earth/>) with the tools available on the bottom right of the screen:
 - Zoom in and out using the – and +
 - View imagery in 2D or 3D
 - Change the cardinal direction of your view using the compass arrow
- Create **New Feature**. If you would like a demonstration, watch the video Google Earth Tutorial: Adding Features [YouTube] (<https://www.youtube.com/watch?v=-XcLcF-huCo&t=38s>). There are lots of icons available to customize placemarks, lines, or shapes. Learn to use:
 - **Add Placemark** to add a point in the tour; and
 - **Draw line or shape** to clearly outline, identify and sketch the landform.

Step 3: Add Stops to Your Tour

If you know where your starting location is, zoom to it manually, or else use the **Search** tool on the left of the screen (type in the place name or coordinates (Lat/Long) and press **Enter** on your keyboard). **Note: Your starting location must be a braided stream** (see Table 21.2).

Identify the examples of the fluvial landform you find as follows:

1. Braided stream (Feature #1)
2. Meandering stream (Feature #2), including the following additional Features (#3 – 9) for the same

stream, or find these features at different locations:

- a. Point bar (outline the location of the point bar, #3)
 - b. Cut bank (trace the cut bank, #4)
 - c. Neck (draw a line between the two meanders to distinguish the neck, #5)
 - d. Cut off (outline a location where a meander has been cut off from the stream, #6)
 - e. Oxbow lake (outline the oxbow lake, #7)
 - f. Meander scar (outline the meander scar, #8)
 - g. Local base level for the meandering stream (add placemark, #9)
3. Delta (outline the location of the delta, Feature #10)
 4. Fluvial fan (outline the location of the fan, Feature #11).

Follow the instructions below to create new features.

- **Step A:** To add a stop to your tour, click on **New Feature**.
- **Step B:** Select **Draw line or shape** to outline the landform, and click on the map. Each fluvial landform must be carefully outlined to demonstrate your understanding.
- **Step C:** In the **Save to project** box, type the name of the landform and your last name (e.g., Meander scar, Doe) into the **Place title** box.
- **Step D:** Click **Edit place**. Select an appropriate colour with at least 4px size border. **Do not** include shading within the shape. Set **fill colour** to 0%. Adding fill colour will make it difficult for your instructor to view your landform.
- **Step E:** Click **Edit place**. Add **Small info box**. In the info box, type a description of the feature, including evidence and an explanation of how this specific landform was formed. Be as specific as possible here; **do not** generally discuss the landform type. It may be interesting to note any evidence of human interference with the landform that may have influenced its development.
- **Step F:** If possible, add a referenced image to further enhance the tour by clicking on the camera icon at the top of the editing panel and uploading. If using images from the web, proper image attribution must be included.
- **Step G:** Repeat steps A – F for each of the 11 features. Note that Google Earth (Web) (<https://www.google.com/earth/>) autosaves your work; you do not need to manually save the Project at any point.

Step 4: Preview Your Tour So Far

Watch your tour by clicking **Present**. The features **must** be in chronological order (Table 21.2). Use Table 21.2 as a guide to identifying landforms as well as a checklist. You can rearrange the order of your stops if necessary by clicking and dragging to a new location in the feature list of your Project.

Table 21.2. Chronological order of landforms, what to look for in Google Earth (Web) and checklist.

Feature #	Landform	What to Look For	Check
1	Braided stream	<ol style="list-style-type: none"> 1. Multiple channels. 2. No or little (young) vegetation on islands commonly shaped like rounded diamonds of gravel or sand between channels. 3. High sediment load. 4. Most originate from glaciated areas; can form in other settings downstream from large quantities of sediment such as volcanoes. 5. Often found downstream of terrain that experiences significant erosion, including mountain ranges. 6. Can occur in low-gradient areas with abundant fine sediments like deserts. 7. Common pattern on alluvial fans. 	
2	Meandering stream	<ol style="list-style-type: none"> 1. Streams channel resembles snake-like (sinuous) pattern with a series of broad loops. 2. Mid-channel bars (islands) are uncommon and have established vegetation. 3. Streams migrate laterally by sediment erosion on the outside bend of the meander and deposition on the inside of the bend. 4. Numerous oxbow lakes and abandoned channels may be located in the floodplain surrounding the stream. 	
3	Point bar	<ol style="list-style-type: none"> 1. Located inside of the meander. 2. Gently slope towards the water edge. 3. Obvious sediment accumulation when stream level is low, has little to no vegetation, and appear light-coloured. 	
4	Cut bank	<ol style="list-style-type: none"> 1. Located at outside edge of the meander. 2. No deposited sediment. 3. Often a steep slope between the stream edge and surrounding vegetation on the flood plain. 4. Narrow band or no light-coloured sediment exposed. 	
5	Neck	Locations where two cut banks on meanders are narrowing the distance between two meanders.	

Feature #	Landform	What to Look For	Check
6	Cut off	<ol style="list-style-type: none"> 1. Straight new stream channel section adjacent to a newly formed oxbow lake. 2. In some locations the edge of the new stream channel will have natural levees separating the new channel and the oxbow lake. 3. Secondary channels that cut across a meander are not cut offs. 	
7	Oxbow lake	<ol style="list-style-type: none"> 1. Meander full of water separated from the main channel. 2. Adjacent to a suspected oxbow lake will be a cut off in the main channel. 3. Artificial levees may separate the oxbow lake and the main channel. 	
8	Meander scar	<ol style="list-style-type: none"> 1. Evidence of past oxbow lake adjacent to stream cut off. 2. Often filled with young vegetation and can be important wetland areas. 	
9	Local base level	<ol style="list-style-type: none"> 1. Follow the stream channel until it reaches a local base level (larger stream or lake) or ultimate base level (i.e. sea level). 2. Look for delta landforms. 	
10	Delta	<ol style="list-style-type: none"> 1. Locations where streams enter a standing body of water such as ocean or lake. 2. Distinct pattern of drainage often similar to branching of tributaries. 3. Often (but not always) triangular in shape (resemble the Greek letter delta (Δ)). 4. The shape may depend on the stream's sediment load, influence of water currents in the other body of water, and whether or not surrounding land prevents the spreading of the delta sediment. 	

Feature #	Landform	What to Look For	Check
11	Fluvial fan	<ol style="list-style-type: none"> Often cone-shaped. The apex (higher elevation) is the narrowest part of the fan and the apron (lower elevation) is the widest part. Can range in size from the very small to the truly massive (the largest are often seen best from space). Evidence of multiple stream channels on the fan surface. (When water flows through channels on the alluvial fan it only occupies a small portion of the fan at any one time. Over many centuries or longer, the streams will migrate from one side of the fan to the other, building it up.) 	

Step 5: Create the EX1 Portion of Your Lab Report

Once the tour is complete, save screenshots of each landform. Excellent screen captures (images of your landform) should be textbook quality so that other students could learn from it. Open a Word document, and insert a title for this portion of the lab report, **Exercise 1**. Paste each image in to create your lab report. Set up the document in **Layout – Orientation – Landscape** with images taking up at least 75% of the area of the page.

For each image, include figure captions and attributions. Figure captions must include figure number, fluvial landform, description, latitude and longitude in decimal degrees, and attribution.

For example: **Figure 1. Braided Stream.** <<Insert description>>. << Insert latitude and longitude in decimal degrees>>. *Figure courtesy of Google Earth.*

Save the report to a known location and continue on to EX2.

EX2: Calculate Stream Gradient

Using Google Earth (Web) (<https://www.google.com/earth/>), calculate the approximate stream gradient (stream slope) for both the braided and meandering stream selected in EX1, and add them to your tour. For each calculation:

- Draw an accurate line following the thalweg of the main channel of the stream reach, and
- Include a detailed list of measurements and calculations.

Step 1: Measure Elevation Change (Rise) and Horizontal Distance (Run) for Braided Stream

- Step A:** Zoom to your braided stream. Find 20 m of elevation loss in the main channel of the stream by hovering the pointer (mouse) over the channel and reading the elevation from the bottom right corner of screen.

- **Step B:** Add a **New Feature** of the **Draw a line** type. Draw a line between the upstream (higher) elevation and downstream (lower) elevation of the stream reach that represents 20 m of elevation loss. Remember to **follow the path of the channel** and not just the straight distance. Note the general direction of flow of this stream. Label this line as Feature #12.
- **Step C:** Measure the channel length distance using the **Measure distance and area** tool located on the **Menu** on the left side of the screen (ruler icon). Collect the measurement following the feature line you drew that traces the path of the channel.

Step 2: Calculate Gradient for Braided Stream

Enter the following information about the gradient calculation in the info box through either **Edit place** when first creating the feature or **Edit feature** from the Project menu:

- Upstream elevation = ___ m
- Downstream elevation = ___ m
- Elevation change (rise) = ___ m
- Horizontal/channel distance (run) = ___ km
- Gradient = ___ %
- Gradient = ___ °
- Gradient = ___ m/km

Step 3: Repeat for Meandering Stream

Repeat steps 1 and 2 for your meandering stream but label as Feature #13.

Step 4: Create the EX2 Portion of Your Lab Report

Save screenshots of each landform with gradient calculation and add to a new section of your lab report with the title **Exercise 2**. Ensure that the document is in **Layout – Orientation – Landscape** with images taking up at least 75% of the area of the page. Add descriptive captions.

For example: **Figure 13. Stream Gradient.** <<Insert description>>. << Insert latitude and longitude in decimal degrees>>. Figure courtesy of Google Earth.

Reflection Questions

Please take 15 minutes to answer the following questions.

1. Reflecting on the imagery in Google Earth (Web) (<https://www.google.com/earth/>) respond to the following questions:
 - a. Is the imagery in real-time? Why or why not?
 - b. Are the braided and meandering streams observed during flooding, baseflow, or something in between? Support this answer with evidence from the exercises.

2. Compare and contrast the gradients calculated in EX2 for the two streams included in EX1. Reflect upon your understanding of how the value of the calculated gradient indicates the dynamics of the stream including its ability to erode, transport, and deposit sediment. What other information would you need to learn in order to make a more informed answer to this question?
3. What are the limitations of measuring gradient using Google Earth?

Create a new section of your lab report and give it the title **Reflection Questions**. Type in your answers.

Report Submission

Once all exercises are complete, save the assignment as a PDF and submit as directed by your instructor. The PDF submission should be saved in **Layout – Orientation – Landscape** with images taking up at least 75% of the area of the page. Confirm with your instructor if you are required to submit the KML file in addition to the PDF.

Worksheets

Lab 21 Instructional Tour

- Lab 21 Instructional Tour [KML] (https://drive.google.com/file/d/1lDzjEgo_SUwk3yQ2l-VR2crXtxZL9e_Y/view?usp=sharing)
- Lab 21 Instructional Tour [PDF] (https://pressbooks.bccampus.ca/geoglabmanualv2/wp-content/uploads/sites/1340/2020/07/PDFSupplement_InstructionalTour_FluvialGeomorphologyLab_v2_08Jun21.pdf)

Lab 22: Alpine Glacial Processes

Crystal Huscroft and Katie Burles

In this lab you will be using your understanding of glacial processes to make observations and measurements documenting and predicting the consequences of climate change for a Canadian alpine glacier. You will learn how to analyze the characteristics of glaciers and glacial landforms from a variety of types and sources of satellite imagery.

Learning Objectives

After completion of this lab, you will be able to

- Make observations, identify, and appreciate the consequences of global warming for alpine glaciers.
- Analyze the characteristics of alpine glaciers in order to make predictions regarding the future survival of a glacier.
- Summarize and collate Geographic Information System (GIS) point, line, and area information from different platforms into a single GIS project.
- Acquire and interpret remotely sensed imagery.
- Communicate effectively regarding the impacts of global warming for British Columbian glaciers.

Pre-Readings

Introduction to Glacial Processes and Landforms

Understanding of the following key terms is required for this laboratory activity:

- Ablation zone
- Accumulation zone
- Annual ice horizon
- Cirque glacier
- Crevasses
- Equilibrium line
- Firn

- Glacial ice
- Glacier toe
- Moraine
- Snowline
- Trimline
- Valley glacier

If you are unfamiliar with any of these terms, look them up before continuing.

How to Determine Whether a Glacier Will Survive Current Climate

You will be asked to predict whether or not the glacier that you choose to study will survive within the current climate. Glaciers form and persist in areas where snow accumulation is consistently equal to or greater than snow and ice melt or sublimation (ablation). Glaciers that are in danger of disappearing will show evidence of insufficient snow accumulation to persist through the melt season. As described by Dr. Mauri Pelto on Glacier Survival website (<https://glaciers.nichols.edu/glacier-survival/>) (please read) and Forecasting temperate alpine glacier survival from accumulation zone observations [PDF] (<https://glaciers.nichols.edu/wp-content/uploads/2018/04/tc-4-67-2010pdf.pdf>) (Pelto, 2010), the likelihood of a glacier's survival can be assessed using the following visual clues in satellite imagery:

1. Newly exposed rock outcrops in the accumulation zone. These rock outcrops may appear lighter than surrounding rock due to a lack of lichen growth on their surface.
2. Lowering of the surface and a reduction in size of the upper margins of the glacier. This might also be indicated by light coloured rock margins around the edges of the glacier due to exposure of unvegetated (mostly lichen) rock and debris.
3. Discontinuous snow cover in the accumulation zone. This may appear as patches of bare ice surrounded by snow.
4. Less than a third snow cover over the glacier late in the melt season.

Video 22.1 captures a glaciologist, Dr. Mauri Pelto, applying the concepts above and performing the same type of analysis that you are asked to perform in this lab.

Video 22.1. Analyzing Sacagawea Glacier, Wind River Range Wyoming Survival (<https://www.youtube.com/watch?v=LOqemjw225k>).



One or more interactive elements has been excluded from this version of the text. You can view them online here: <https://pressbooks.bccampus.ca/geoglabmanualv2/?p=299#oembed-1> (#oembed-1)

Introduction to Sentinel 2 Imagery

In this lab, you will be analyzing false colour images captured by the Sentinel 2 satellite program. The Sentinel 2 program consists of twin satellites launched by the European Space Agency that are able to capture imagery of Earth at a resolution of 10-60 m. It consistently captures images between 56° S to 84° N every 5 days. Unlike our eyes, the satellite system can detect energy in the visible, near-infrared and shortwave infrared portions of the electromagnetic spectrum.

Although the satellites measure 13 spectral bands of reflected and emitted energy, false colour images using three specific bands of energy are excellent for studying glaciers because they are able to detect and differentiate ice and snow (Bands 11, 8A, 4). In these false colour images, snow appears light teal blue, ice appears dark teal blue, and water appears a very dark shade of blue.

Calculating Rates of Glacier Advance or Retreat

A **rate** is the amount of change in some quantity over a given period of time. In this lab we are interested in rates of advance or retreat of glaciers. This rate of movement is the rate of change (Δ) in distance per change in time. Glaciers move slowly, and so in this context the rate is commonly expressed in metres per year (m/y). The rate may be expressed as (Equation 22.1):

Equation 22.1

$$\text{Rate} = \frac{\Delta \text{ Distance}}{\Delta \text{ Time}}$$

Glaciers generally advance each winter and retreat each summer. However, these annual advances and retreats may not be equal and so, over time, the glacier toe may, on average, advance or retreat. The average rate of advance or retreat is calculated by taking the total distance that the glacier toe has moved from the defined starting point/time and dividing it by the number of years that have elapsed.

For example, if the glacier has retreated 70 m in 35 years, using Equation 22.1,

$$\text{Rate} = \frac{\Delta \text{ Distance}}{\Delta \text{ Time}}$$

$$\text{Rate} = \frac{70 \text{ m}}{35 \text{ y}} = 2 \text{ m/y.}$$

For a more detailed explanation of calculating rates, please refer to SERC Carleton's How do I calculate rates? Calculating changes through time in the geosciences (<http://serc.carleton.edu/mathyouneed/rates/index.html>).

Lab Exercises

In the exercises in this lab, you will choose a Canadian glacier and create a report consisting of satellite

imagery and commentary regarding the likelihood of your glacier's survival in the current climate. You will be accessing topographic and satellite information regarding your glacier from the following platforms so that you can discuss factors that have affected your glacier's behaviour in terms of retreat and the likelihood that the glacier will survive current and future warming:

1. Google Earth (Web) (https://www.google.com/intl/en_ca/earth/)
2. The Atlas of Canada – Toporama (<https://atlas.gc.ca/toporama/en/index.html>)
3. Sentinel Playground (<https://apps.sentinel-hub.com/sentinel-playground/>)

You will be guided to complete a lab report, which you will save as a PDF.

EX1: Describing a Canadian Alpine Glacier

Step 1: Choose a glacier.

1. Open The Atlas of Canada – Toporama (<https://atlas.gc.ca/toporama/en/index.html>). **Warning: this site loads slowly. If all you see is a link to GeoGratis, give it a few more moments to load a map.** Explore the mountainous regions within Canada and choose an alpine glacier somewhere in Canada that you would like to study. In Toporama, you will see white areas denoting alpine areas, and then blue areas within the alpine areas denoting glacial ice. Glaciers are labelled in pink. Many Canadian glaciers are not named, however you may want to choose one that is for ease of reference.
2. Determine the geographic grid coordinates (latitude and longitude) of your glacier in decimal degrees. In Toporama, this is done by clicking on the **Menu** drop-down in your Toporama viewer and the **Get coordinates from the map** tool. Click on your glacier and record the decimal degrees of your location.
3. Ensure that there is good satellite imagery for your chosen glacier in Google Earth (Web). Open Google Earth (Web) (https://www.google.com/intl/en_ca/earth/) and familiarize yourself with the navigation controls. In the **search** pane, type in your location in decimal degrees. Examine your glacier. It is best to choose an alpine glacier that is not too snow-covered in the Google Earth (Web) imagery so that the margins of the glacier are clearly visible. Also, cirque glaciers with a single outlet will be simpler to map than icefields with multiple outlets.

Step 2: Create an oblique 3D view of the glacier.

1. Within Google Earth (Web), view your glacier in 3D. Tilt your view and navigate to a view of the glacier that gives a good perspective of the shape and steepness of your glacier, and enough of the adjacent topography to give the viewer an idea of the character of adjacent mountains.
2. Create a screen capture of this view and save it as a JPEG file with a file name in the format <1_lastname_firstname_3D_image>. Your glacier should take up the majority of the center of the photo, so that it is obvious as to which glacier you are studying. This image will be Figure EX1.1 of your final lab report.

Step 3: Create a title page, slide and introduction (Figure EX1.1).

1. The image in Step 2 will be the image for the title slide in your lab report and Google Earth (Web) presentation. Paste your image into a document that can later be saved as a PDF. Be sure to set up your document to **landscape** orientation. A sample student assignment can be found in Worksheets.
2. Resize the image so that the image and caption for Figure EX1.1 can fit on one page in **landscape** orientation. Figure 22.1 provides an example.
3. Write a figure caption in paragraph form that includes the following information:
 1. The glacier's geographic grid coordinates in decimal degrees (latitude and longitude).
 2. The direction of view of the image. What direction (north, east, south, west) is the camera looking in the image you attached?
 3. The glacier's name (if applicable). Many Canadian glaciers are not named. If you haven't already, you can check if your glacier has a name on The Atlas of Canada – Toporama (<https://atlas.gc.ca/toporama/en/index.html>) website.
 4. A description of the glacier's location relative to major landmarks like towns, lakes, highways. For example, **30 km northeast of Pemberton**.
 5. The physiographic region the glacier is located within. Depending on the province or territory where you chose your glacier, you will need to refer to the following reports:
 - British Columbia [PDF] (https://www.for.gov.bc.ca/hfd/pubs/Docs/Lmh/Lmh66/Lmh66_ch02.pdf) (see Figure EX2.1 in this document)
 - Alberta [PDF] (<https://open.alberta.ca/dataset/61428176-224c-48fe-9728-f70888158855/resource/55809b6c-a1ca-4613-ad31-8a2fc1bef9c7/download/sm-03-physiographic-subdivisions-of-alberta.pdf>)
 - Yukon [PDF] (<https://geoscan.nrcan.gc.ca/starweb/geoscan/servlet.starweb?path=geoscan/shorte.web&search1=R=122821>)
 - Nunavut and North West Territories (click to download the zip file of the Physiographic Regions of Canada GSCmap-a_1254A_e_1970_mn01 (https://ftp.maps.canada.ca/pub/nrcan_rncan/publications/STPublications_PublicationsST/293/293408/as_1254.zip) and open **gscmap-as_1254A_e_1970.pdf** from the **doc** folder).
 6. A description of the main bodies of water that the glacier meltwater feeds. At a minimum, you should indicate the name of the major streams that drain the glacier's meltwater and the receiving ocean. You can see this by tracing the flow of water from the glacier to an ocean using The Atlas of Canada – Toporama (<https://atlas.gc.ca/toporama/en/index.html>) website.
 7. A description of why you chose the glacier. This is a short description and there is no wrong answer. Just be honest. Maybe you have seen this glacier, maybe you would like to travel there, or maybe your choice was completely random. If you have your own personal picture of the glacier that you would like to share, please include it as Figure EX1.1b. Your lab instructor would love to see it. You can choose to copyright it or release as Creative Commons by using this copyright builder (<https://www.openwa.org/attrib-builder/>).

8. A description of the image source. The source of all images used in any report should be described.



(<https://pressbooks.bccampus.ca/geoglabmanualv2/wp-content/uploads/sites/1340/2020/07/>

Figure-20.1-Huscroft-3D-GE-image.jpg)

Figure 22.1. Sample Figure EX1.1 in a student's assignment. Note that the view is an oblique (side-on) view, the glacier is at the center of the photograph, and that the landscape around the central glacier is visible. A student assignment should include information such as the unnamed glacier (pictured above looking south) is located to the east of the southern end of Tsilhqox Biny (Chilko Lake) within Ts'il'qos Provincial Park in the central Coast Mountains of British Columbia (51.093, -123.979). This glacier, as with many of the glaciers in this region, is an important source of late summer stream flow for Rainbow Creek, Tsilhqox Biny (Chilko) Lake, Chilko River, the Chilcotin River, and the Fraser River before it drains into the Pacific Ocean. Source: Sampled from Google Earth by C. Huscroft. Used in accordance with Google Earth terms and conditions. [Click to view image full size]

Step 4: Create and analyze a topographic map (Figure EX1.2).

1. Figure EX1.2 of your report will be a topographic map with a north arrow and a scale bar of your glacier. Refer to the example Figure 22.2. In order to create the image, within The Atlas of Canada – Toporama (<https://atlas.gc.ca/toporama/en/index.html>), navigate back to a view of your glacier that captures the entire glacier from its source area.
2. Using the **Measuring and Drawing Tools** menu on the left of your window, select a yellow pencil tool and draw a yellow arrow indicating the top elevation of your glacier's source area as well as a red arrow indicating the bottom elevation.
3. Take a screen capture of your image that **clearly shows** the scale bar, the north arrow, the contours above and below your glacier, your yellow arrow, your red arrow and the north arrow.
4. Save this image with a memorable file name. Paste this image onto the next page of your lab

report in landscape view so that the image takes up most of the page, but still leaves room for the caption.

5. Write a caption for your figure that includes the following:

1. The aspect of the glacier. The aspect of the glacier indicates the direction that the glacier is facing or sloping down towards (north, east, west, or south-facing).
2. The maximum and minimum elevation of the glacier based on interpolating between the contour lines.
3. Whether or not the glacier originates from a cirque or valley glacier.
4. The image source and the date accessed.

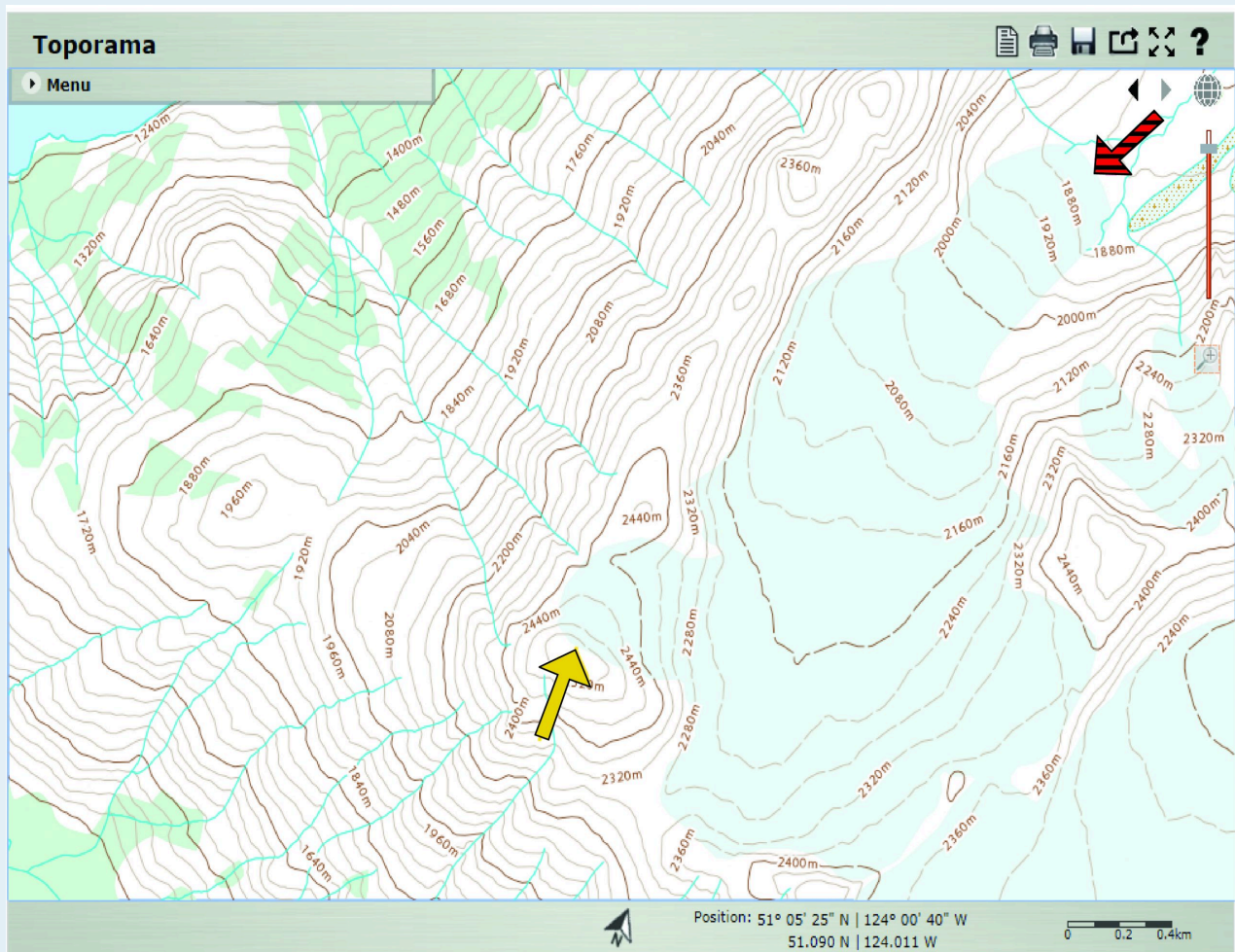


Figure 22.2. Sample Figure EX1.2 in a student's assignment. Note that both the scale bar and the north arrow are visible. The solid yellow arrow indicates highest elevation of glacier, although it is not the center of flow, so was not used in the glacier length calculation. The striped red arrow indicates location of lowest elevation. Accessed June 8th, 2020. Source: Sampled from *The Atlas of Canada- Toporama* (<https://atlas.gc.ca/toporama/en/index.html>) by C. Huscroft. Used in accordance with Government of Canada non-commercial reproduction terms of use (<https://www.canada.ca/en/transparency/terms.html>). [Click to view image full size]

Step 5: Describe the length of the glacier (Figure EX1.3).

1. In Google Earth (Web) (https://www.google.com/intl/en_ca/earth/) start a new project and name it <Lastname Firstname Glacier Survival Lab>.
2. Create a new line feature by digitizing a centerline for the glacier that extends from the approximate center of the upper extremity of the glacier to the lower extremity. Your line should follow the topography downwards. Your line should parallel the glacier flow direction and any downhill sloping debris bands. Name this feature **Glacier length**.
3. Next, measure the length of this line with the **Measure** tool (**ruler icon** on the left side of your screen). While the value of the length is still displayed in a white box, take a screen capture of this measurement including the Google icon, and use the image as Figure EX1.3. Figure 22.3 provides an example.
4. Write a caption that describes the length of the glacier to the nearest 10 m, the image source and the date accessed.



(<https://pressbooks.bccampus.ca/geoglabmanualv2/wp-content/uploads/sites/1340/2021/03/figure-20.3-huscroft-glacier-length.jpg>)

Figure 22.3. Sample Figure EX1.3 in a student's assignment. Source: Sampled from Google Earth by C. Huscroft. Used in accordance with Google Earth terms and conditions. [Click to view image full size]

Step 6: Identify evidence of Little Ice Age Glacier extent (Figure EX1.4).

In this figure, you will try to depict any evidence of the past maximum extent of your glacier during the Little Ice Age. The Little Ice Age was a period of cool climate when glaciers in Europe and North America

advanced from their current positions. The period spanning from 1100 Common Era (CE) to 1850 CE includes several series of advances. The evidence left on the landscape from these advances includes trimlines and moraines that wrapped around the edges and toe of the glacier.

1. Zoom out from the view of your glacier to include the area down slope of the toe of your glacier. Using a green line, trace any features you see that could indicate how far your glacier once extended. If you do not see any indicators of past glacier extents (they may be obscured), you do not need to add any features.
2. If you found clues as to prior glacier extents, measure how long the glacier once was. While the value of the measurement is still visible in a white box, create a screen capture and save the file as <4_Lastname_Little Ice Age>. If you did not see any evidence, create a screen capture of a view that supports your assertion that no features are evident and also save this file as <4_Lastname_Little Ice Age>. This will be Figure EX1.4 in your lab report. Figure 22.4 provides an example.
3. Write a caption for Figure EX1.4 that indicates the types of clues you used and a measurement of how long the glacier may have extended during the Little Ice Age. If you did not find any clues, write a caption saying so and indicate the types of features that were absent.



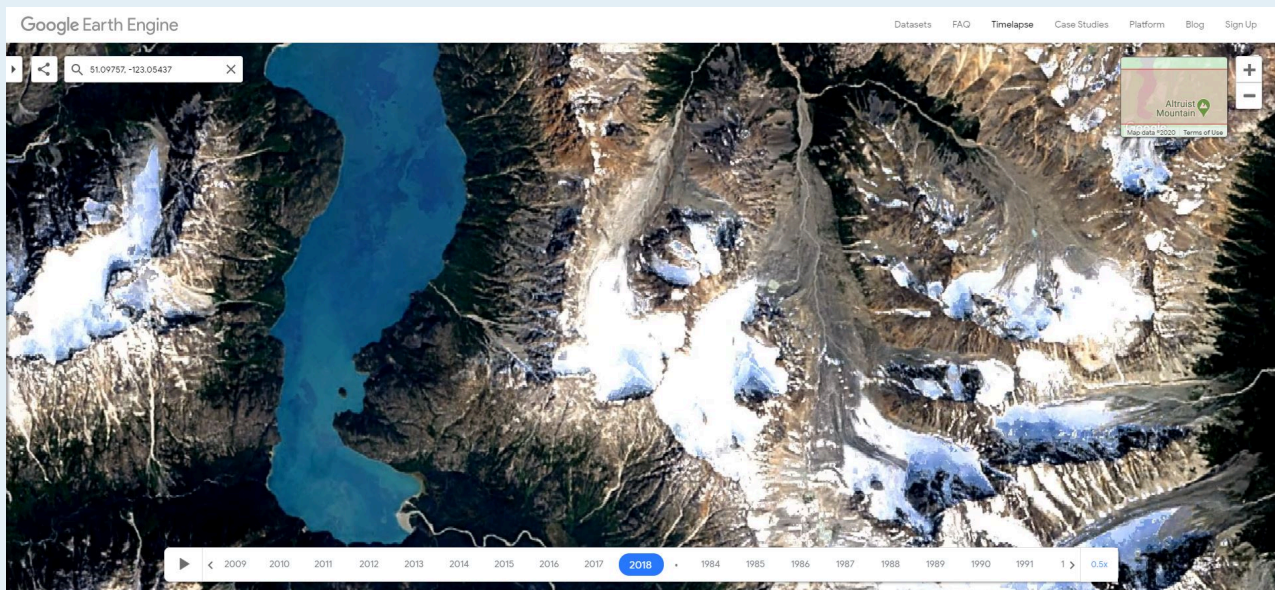
(<https://pressbooks.bccampus.ca/geoglabmanualv2/wp-content/uploads/sites/1340/2021/03/Figure-20.4-Huscroft-LIA-extent.jpg>)

Figure 22.4. Sample Figure EX1.4 in a student's assignment. Source: Sampled from Google Earth by C. Huscroft. Used in accordance with Google Earth terms and conditions. [Click to view image full size]

EX2: Analyzing Glacier Change and Processes With Satellite Imagery

Step 1: Capture Google Earth Engine Timelapse imagery (Figures EX2.1 & EX2.2).

1. Visit Google Earth Engine Timelapse (<https://earthengine.google.com/timelapse/>) and navigate to a large scale view of your glacier. It may load slowly, so give it a few moments. Zoom in as far as possible with your glacier in the centre of the view. Press the **pause** button on the lower left of the screen, then choose the earliest view (e.g., 1984) where the position of the toe of your glacier is visible. The earliest view should be before 1990.
2. Create a screen capture of this view and save it with the file name <5_Lastname 1984 imagery>. Add the image to your document as Figure EX2.1.
3. Write a caption for Figure EX2.1 indicating what the image is of, the date of the imagery and include a link to this view by using the **Share Current View** button and pasting it as the image source.
4. Keeping the exact same view, repeat the previous three steps to produce Figure EX2.2 using the most recent imagery and save the screen capture with the file name <6_year_Lastname_Glacier_extent>. Figure 22.5 provides an example. Write a caption for Figure EX2.2 describing any changes you observe.



(<https://pressbooks.bccampus.ca/geoglabmanualv2/wp-content/uploads/sites/1340/2021/03/Figure-20.6-Huscroft-2018-imagery.jpg>)

Figure 22.5. Sample Figure EX2.2 in a student's assignment. This image depicts the glacier in 2018. As compared to the 1984 image (Figure EX2.1), we can see that the glacier toe has receded, the toe narrowed, a rock island has appeared in the upper regions of the glacier. Also, the upper area has started to divide more distinctly into three smaller cirques. This could suggest the glacier is thinning in the accumulation zone. Source: Google Earth Engine Timelapse – glacier

(<https://earthengine.google.com/>

timelapse#v=51.09999,-124.00105,11.621,latLng&t=2.34&ps=50&bt=19840101&et=20181231&startDwell=0&endDwell=0) Sampled from Google Earth by C. Huscroft. Used in accordance with Google Earth terms and conditions. [Click to view image full size]

Step 2: Estimate the approximate location of the glacier toe in 1984 (creating a point feature and Figure EX2.3).

1. Using landmarks visible in the earliest good imagery from Google Earth Engine Timelapse (<https://earthengine.google.com/timelapse/>) (this will most likely be 1984), add a point feature to your Google Earth project and move it to your best estimate of the location of the toe of the glacier in 1984. Use as many landmarks as possible to situate your point. Make sure your view is in 2D and it helps if you view both images at the same scale.
2. For comparison, measure the length of the glacier you estimate in 1984 and create a screen capture of your measurement while the value of the measurement is still visible. Save this screen capture of Google Earth (Web) as <7_Lastname_1984_approximate_glacier_toe> (example provided as Figure 22.6).



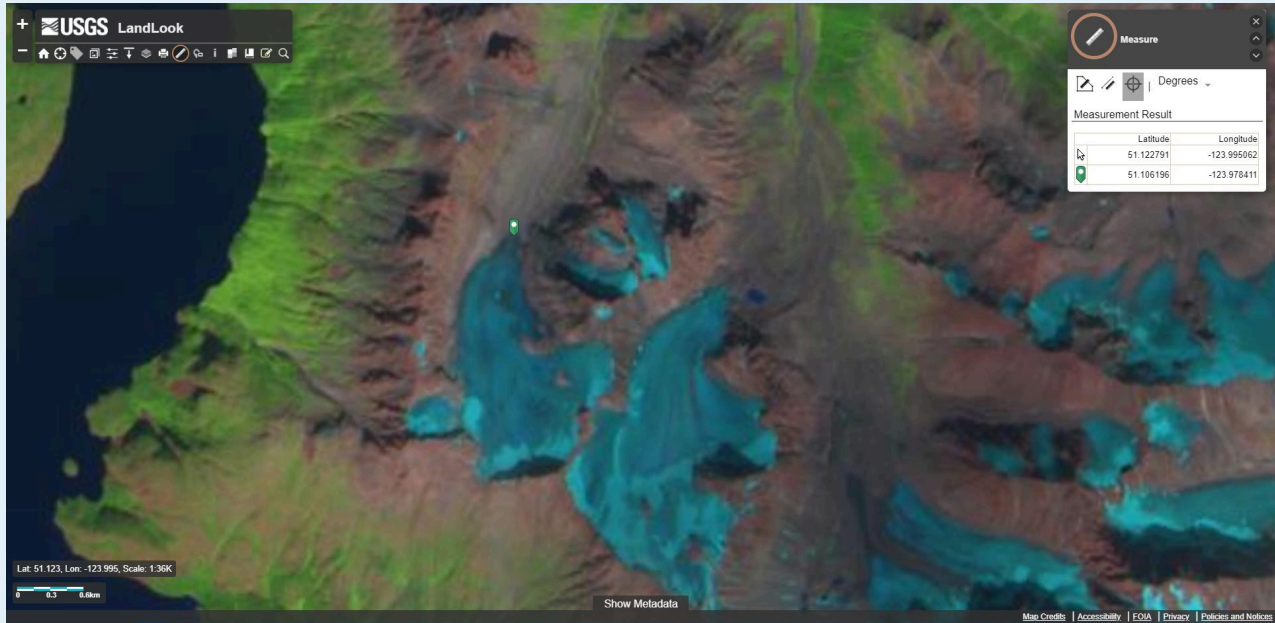
(<https://pressbooks.bccampus.ca/geoglabmanualv2/wp-content/uploads/sites/1340/2021/03/Figure-20.7-1984-Glacier-toe-position.jpg>)

Figure 22.6. Sample Figure EX2.3 in a student's assignment. By locating the approximate position of the toe in 1984 Google Earth Engine Timelapse imagery, we can see that the glacier was 2.8 km long in 1984. Source: Sampled from Google Earth by C. Huscoft. Used in accordance with Google Earth terms and conditions. [Click to view image full size]

Step 3: Analyze the accumulation zone in the most recent satellite imagery (Figure EX2.4).

1. Go to the Sentinel Playground (<https://apps.sentinel-hub.com/sentinel-playground/>) for viewing recent satellite imagery and navigate to a large scale view of your glacier.
2. View your chosen glacier by typing in the coordinates or name of your glacier or name of your glacier in the **search pane (magnifying glass icon)** and zoom in until the glacier fills a lot of your map area.

3. In order to find the date of the best Sentinel 2 image capturing the most recent size and pattern of the accumulation zone, use the calendar at the top of the page. Inspect the summer and early fall images in order to find the year's true accumulation zone. This date coincides with the time of year when the size of the preserved snowpack from the previous winter will be at a minimum. Therefore, set the date range for your search to mid or late summer. For glaciers in low latitudes (southern and central BC or Alberta), someone would typically need to inspect from early August to late September. For glaciers in higher latitudes (Yukon, Nunavut and northern BC or Alberta) inspect from early July to Late August. However, anomalous years do occur and one might need to look at later years.
4. Once you have found the best image, use the menu on the left, and set the menu to Custom and drag the following Band onto the output fields R:12 G:8a B:4 . This band combination accentuates snow surfaces from ice as well as water.
5. Press the **Generate** button. Copy the URL of this image (button on bottom) and download the image.
6. Create a screen capture of the glacier and save it in a file named <8_Lastname_daymonthyear_Sentinel_2_image>.
6. Add this file to your document as Figure EX2.4 (refer to Figure 22.7 for an example) and indicate the image source by adding the URL of your current view. Do this by using the **Bookmarks** button then **Generate URL** button.
7. Write a caption in which you describe and discuss the following questions:
 - a. What is the likelihood of the glacier disappearing in the current climate regime? Please refer to the visual evidence described in the lab introduction that supports your prediction.
 - b. What observations are you basing your hypothesis on? This involves describing the visual evidence you used.

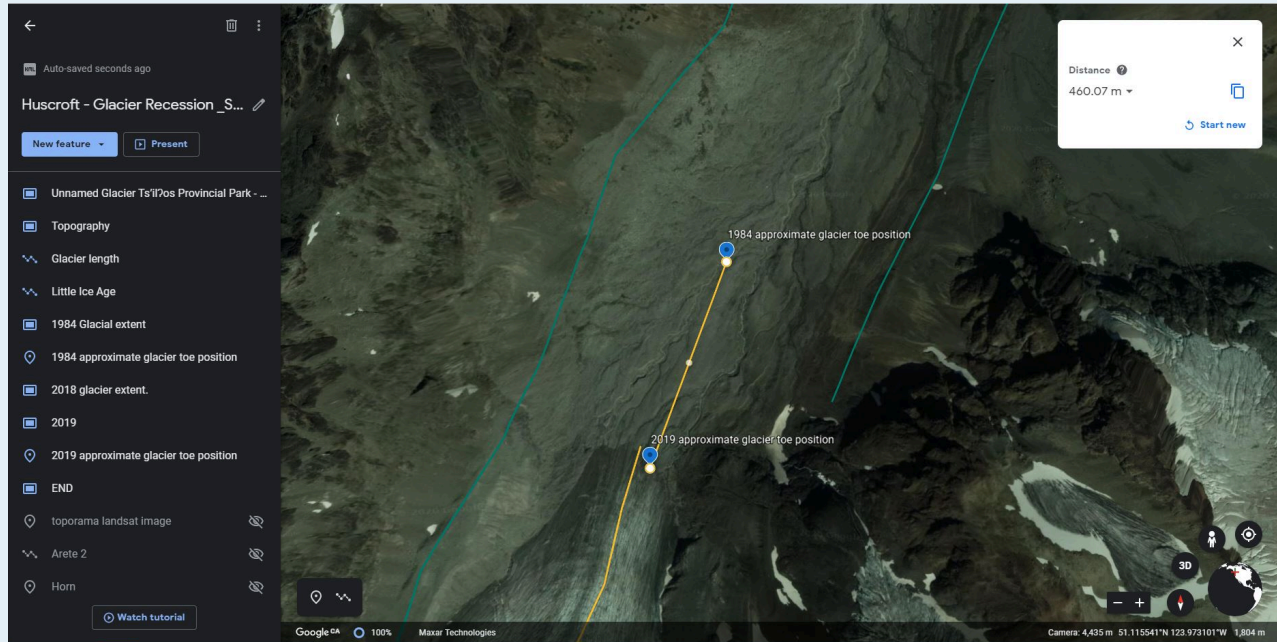


(<https://pressbooks.bccampus.ca/geoglabmanualv2/wp-content/uploads/sites/1340/2021/03/Figure-20.8-Huscroft-29082019-Sentinel-2-image.jpg>)

Figure 22.7. Sample Figure EX2.4 in a student's assignment. Source: Sampled from USGS LandLook by C. Huscroft. USGS materials are in the public domain. [Click to view image full size]

Step 4: Calculate the rate of change (Figure EX2.5).

1. Using the coordinates recorded in the previous step, add a point to your Google Earth (Web) project called <Year approximate glacier toe position>. For example, **2024 approximate glacier toe position**.
2. Measure the distance between this location and the 1984 position and calculate the average rate of retreat or advance of the glacier. Take a screen capture of this measurement and save the measurement as <9_Lastname_glacier_position_measurement>. Add this image to your document as Figure EX2.5. An example is provided as Figure 22.8.
3. Write a caption that includes the total measured retreat (or advance) distance over the period from your earliest photo until the most recent satellite imagery, and the average rate of retreat.



(<https://pressbooks.bccampus.ca/geolabmanualv2/wp-content/uploads/sites/1340/2021/03/Figure-20.9-Huscroft-2019-glacier-toe-position.jpg>)

Figure 22.8. Sample Figure EX2.5 in a student's assignment. Source: Sampled from Google Earth by C. Huscroft. Used in accordance with Google Earth terms and conditions. [Click to view image full size]

Step 5: Get curious and do a small scientific analysis of your own choosing.

1. By exploring the tools and images available to you on the websites you have used so far in this lab, do an extra analysis of your own creation and add extra screen capture(s) as figure(s) that support your analysis as Figure EX2.6 (and additional if needed). Try to keep it as simple as possible. Be sure to state the question you are trying to answer in your analysis as well as your method. Possible analyses could involve:
 - Doing an extra measurement.
 - Accessing imagery from a different time and doing comparisons.
 - Finding imagery on the The Atlas of Canada – Toporama (<https://atlas.gc.ca/toporama/en/index.html>) website or the iMap BC (<https://www2.gov.bc.ca/gov/content/data/geographic-data-services/web-based-mapping/imapbc>) website and comparing glacier toe positions.

Reflection Questions

1. Which part of this activity did you like the most and why? Which did you like the least and why? In which section did you feel you learned the most about glaciers?
2. In one paragraph, share your feelings about:

- Your discoveries in this lab in regard to the survival of your glacier.
- The fact that your classmates have probably come to similar conclusions with respect to other Canadian glaciers.
- How you felt being able to view historical images in order to come up with your own scientific conclusions about a glacier of your choice.

Report Submission

1. Review your text for grammatical and spelling mistakes.
2. Export your document to a PDF. Your PDF file needs to be a reasonable size (generally less than 5MB, but ask your lab instructor for details). In order to do this, you will need to reduce (compress) the file size of all of your images to between 150-100 ppi. Be sure to check that you have not compressed the images so much that you are not able to see them clearly on your monitor. For PC users, the compression can be done with MSWord by clicking on the image, choosing **Picture Tools – Compress**.

Submit as directed by your instructor.

Worksheets

Return to Step 3, EX1

Sample Student Assignment

- Lab 22 Sample Assignment [Word] (<https://pressbooks.bccampus.ca/geoglabmanualv2/wp-content/uploads/sites/1340/2021/03/Lab-20-Sample-Assignment.docx>)
- Lab 22 Sample Assignment [ODT] (<https://pressbooks.bccampus.ca/geoglabmanualv2/wp-content/uploads/sites/1340/2021/03/Lab-20-Sample-Assignment.odt>)
- Lab 22 Sample Assignment [PDF] (<https://pressbooks.bccampus.ca/geoglabmanualv2/wp-content/uploads/sites/1340/2021/03/Lab-20-Sample-Assignment.pdf>)

References

GISGeography. (Last updated 2021, February 27). *5 free historical imagery viewers to leap back in the past*. <https://gisgeography.com/free-historical-imagery-viewers/>

Pelto, M. S. (2010). Forecasting temperate alpine glacier survival from accumulation zone observations. *The Cryosphere* 4, 67–75. <https://doi.org/10.5194/tc-4-67-2010>

Media Attributions

- Sacagawea Glacier, Wind River Range Wyoming Survival (<https://www.youtube.com/watch?v=LOqemjw225k>) by Mauri Pelto (<https://www.youtube.com/user/mspelto>) is licensed under Standard YouTube License.
- USGS EROS | How To Search and Download Satellite Imagery (<https://www.youtube.com/watch?v=Vp8-ZaONudA>) by USGS (<https://www.youtube.com/@usgs>) is licensed under Standard YouTube License.

Lab 23: Coastal Geomorphology

Todd Redding; Stuart MacKinnon; and Fes de Scally

Canada has the longest shoreline of any country in the world, but estimates of how long the shoreline actually is will vary greatly depending on how it is measured. In British Columbia, for instance, the straight-line distance between Vancouver and Prince Rupert is approximately 800 km, but the length of the coastline between the two cities is about 41,000 km when traced on a relatively detailed map.

Waves are the dominant energy source on exposed, open-ocean coasts, and when wave energy is expended on the shoreline, there is the potential for rapid and significant geomorphic change. An understanding of coastal geomorphic processes and landforms is important not only for pure scientific interests but also to avoid potentially disastrous consequences of the human occupation and use of coasts.

Learning Objectives

After completion of this lab, you will be able to:

- Use Google Earth to make geographical measurements.
- Understand the relationships between wave length, period, and velocity.
- Understand the change in wave characteristics as they approach the shore.
- Identify common coastal landforms on satellite images.
- Infer likely patterns of coastal sediment transport on satellite images.
- Understand the contributing factors to coastal sediment budgets and the effects of changes on beach properties.
- Become aware of the shifting nature of shorelines due to long-term changes in sea level.

Pre-Readings

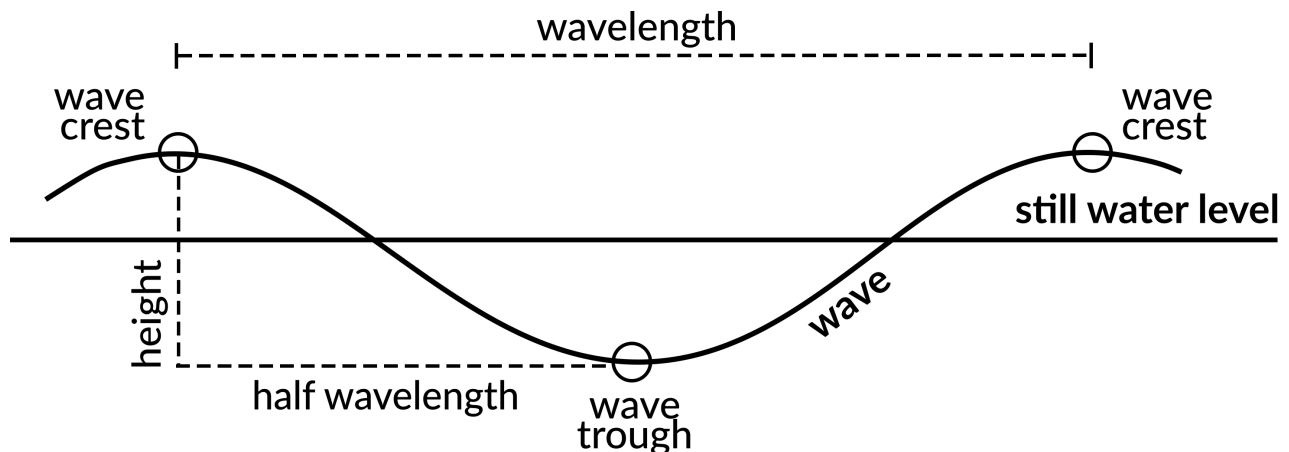
The Littoral Zone

Fundamental to coastal geomorphology is an understanding of the **littoral zone**. The littoral zone includes the coast, beach, nearshore environment, and a part of the offshore environment. This lab concerns itself with the processes that occur in this zone, and the resulting landforms created by erosion, transport and deposition.

Properties of Waves

The source of energy for most coastal erosion and sediment transport is wave action. **Waves** are distortions of the still water surface that contain (a) potential energy by virtue of water molecules being displaced above and below the still water line; and (b) kinetic energy by virtue of water molecules being in motion. The faster the wind and the longer the fetch (or distance of open water across which the wind blows and waves travel), the larger the waves. Large waves have much greater energy than smaller waves, in fact, wave energy is proportional to the wave height squared.

It is important to realize that waves in the open ocean (referred to as **deep water waves**) do not move the water forward, but rather the water molecules move in circular orbits. If you have ever floated offshore in a small boat or inner tube you will know this to be true; a moving wave will pass beneath the boat and cause you to rise and fall but you will not move any appreciable horizontal distance forward or backward. The situation is different close to shore where there is net movement of the water in the direction of wave propagation, but where there can also be currents (e.g., longshore, rips). Waves are described using basic measurements such as wave height, wavelength (Figure 23.1), and wave period.



(<https://pressbooks.bccampus.ca/geoglabmanualv2/wp-content/uploads/sites/1032/2020/09/Figure-21.1-Wave-Characteristics.png>)

Figure 23.1. Wave characteristics. The wave height is the vertical distance between the wave crest and the wave trough. The wavelength is the distance between two successive wave crests or wave troughs. Source: M. Oddo, CC BY-NC-SA 4.0.

Wavelength is defined as the horizontal distance from wave crest to wave crest (or trough to trough), while **height** is the vertical distance between the trough and crest. Both values are commonly measured in metres (m). Open ocean waves are modelled as a sinusoidal curve, with symmetry above and below the still water level. The time taken for successive crests to pass a fixed point is called the **wave period**, measured in units of time such as seconds (s). One of the interesting aspects of wave motion is that the period remains essentially constant despite changes in the wave form as it enters shallow water.

The **velocity** or **phase speed** of the wave, V , can be calculated if the wavelength, L , and the wave period, P , are known (Equation 23.1):

Equation 23.1.

$$V = \frac{L}{P}$$

Given that wavelength is commonly measured in metres (m) and wave period in seconds (s), the units of wave velocity are metres per second (m/s).

For example, let us assume that a wave has a wavelength of 16 m and a wave period of 4 s. The velocity (V) of the wave may be calculated using Equation 23.1 as:

$$V(m/s) = \frac{L(m)}{P(s)}$$

$$V(m/s) = \frac{16m}{4s} = 4 \text{ m/s}$$

This relationship can be re-arranged to solve for wavelength or wave period. A good way to think about how the equation can be re-arranged is by examining the units of the output and making sure they make physical sense to you. For more detailed explanations, please refer to SERC Carleton's How do I calculate rates? Calculating changes through time in the geosciences (<http://serc.carleton.edu/mathyouneed/rates/index.html>) and How do I isolate x (or P or T ...) in a formula? Rearranging equations to solve for a given variable (<http://serc.carleton.edu/mathyouneed/equations/index.html>).

Long period waves (referred to as long waves or swell waves) travel faster than short, locally-generated sea waves. As a consequence, waves have a tendency to sort themselves out as they move away from the storm centre that generates wave motion in the open ocean. Long swell waves that have travelled hundreds of kilometres may have periods of up to 15 seconds. Smaller waves have periods of only a few seconds.

Wave Refraction

In much the same manner as light is refracted (bent) through a prism, waves are subject to refraction or bending of the wave crests as they approach the shore. Whenever waves approach a shoreline at an oblique angle, the presence of the sea floor turns the waves to become more parallel to the shore. The reason is that the offshore portions of the wave crest are not influenced by the bottom and are free to travel at their optimal speed (i.e., their deep-water velocity). In contrast, the onshore portions of the wave crest are impeded by the presence of the bottom and therefore are forced to slow down.

On an indented coast the situation is more complex, but Figure 23.2 below shows what is expected to happen. The wave crests in deep water approach the shore perpendicular to the general trend of the coast. The wave crests approaching the headlands begin to be affected by the sea floor first, when they are just under a kilometre from the shore. These portions of the wave crests slow down, shorten in wavelength, and increase in height. The same crest approaching the bay continues unimpeded (because

water depth in front of the bay is deeper) and so moves ahead of the wave segment at the headland. At position 1 on Figure 23.2 Segments A and B are in deep water and are unchanged, but by the time they have reached position 3, A has slowed down and shortened its wavelength. It therefore lags behind B which is still unchanged. By the time the wave reaches position 4 on Figure 23.2, A is about to break on the headland while B is advancing more slowly into the bay. The end result is that the wave crest is bent progressively by refraction so as to conform to the bathymetric contours and ultimately break parallel to the shoreline.

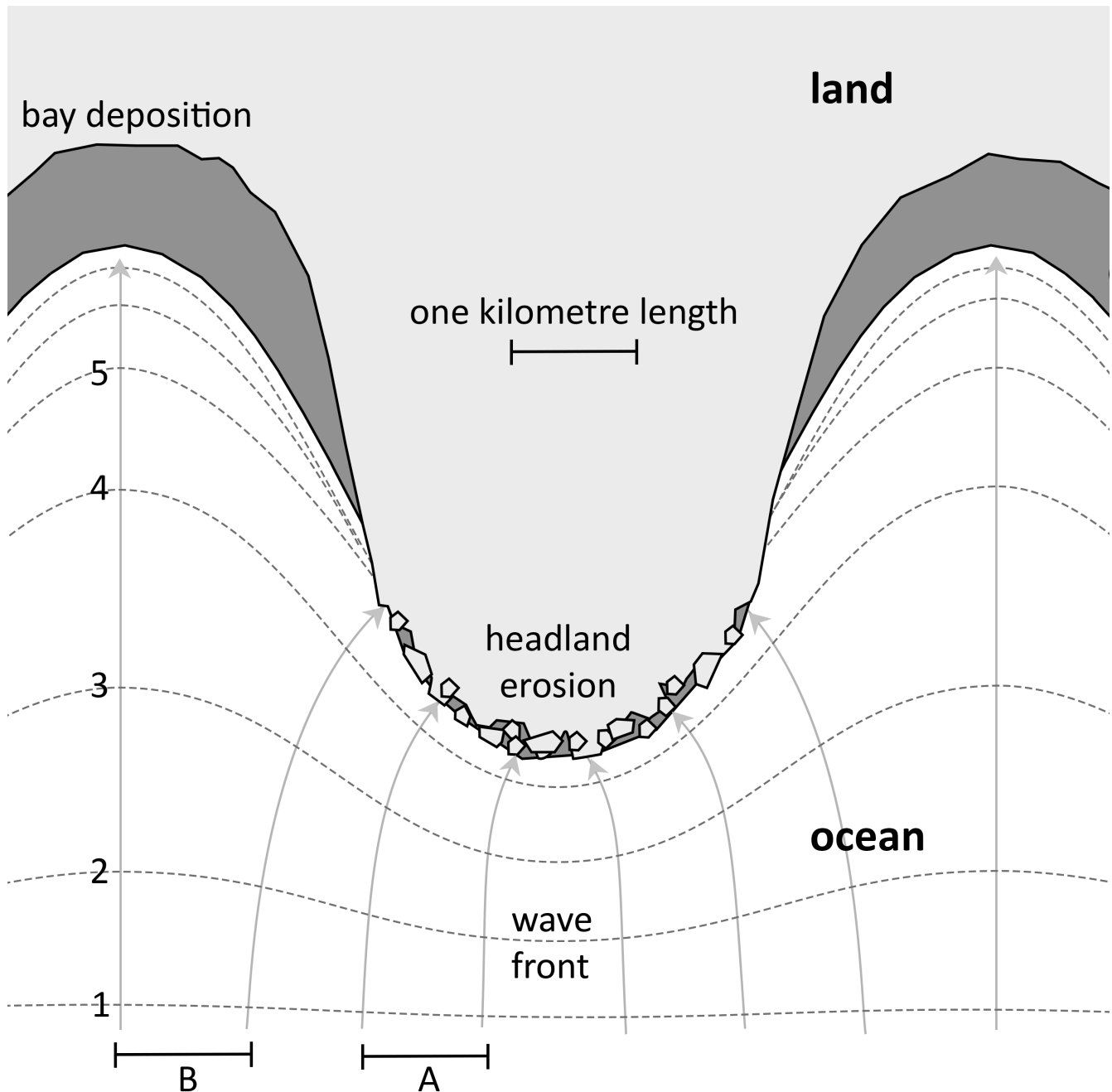


Figure 23.2. Wave refraction at a headland. The dashed lines represent changes to a wave front as it approaches shore. Position 1 is the earliest time, when the wave front is in deep water and unaffected by the shore. The orthogonals (solid lines with arrow heads) indicate the direction of wave travel. Source: M. Oddo and S. MacKinnon, CC BY-NC-SA 4.0.

The convergent pattern of the orthogonal lines show the direction of movement of the wave crest (the solid lines drawn at right angles to the wave crests with arrow tips). The closer spacing of the orthogonal lines near the headlands show how the wave energy in segment A is concentrated onto the headland. In the bay, wave height is reduced since the energy of segment B is spread out across a greater length of shoreline (orthogonals are further apart). Therefore, headlands tend to be sites of erosion while bays tend to be sites of deposition. The tendency is for waves to create a smooth, linear coastline, but this often does not happen because of differences in the strength of rocks (resistance to erosion) on headlands versus embayments.

Erosion, Transportation and Deposition Along Coasts

A number of mechanical and chemical effects produce erosion of rocky shorelines by waves. The types of erosional landforms that result depend on the geology of the coastline, the nature of wave attack, the tidal regime, and long-term Sea Level Change. Examples of erosional landforms include wave-cut notches, marine cliffs, sea caves, arches and sea stacks.

Transportation by waves and currents is necessary to move rock particles eroded from one part of a coastline to a place of deposition elsewhere. One of the most important transport mechanisms results from an oblique angle of wave attack relative to the shoreline orientation. The upward movement of water onto the beach (**swash**) occurs at an oblique angle. However, the return of water (**backwash**) is at right angles to the beach, resulting in the net movement of beach material laterally. This movement is known as **beach drift**. Waves approaching the shoreline at an oblique angle also force **longshore currents**, especially in troughs between nearshore sand bars. The combination of longshore currents with the never-ending cycle of swash and backwash is called **longshore drift** or **littoral drift** and can be observed on all sandy beaches.

In addition, tidal currents along coasts can be effective in moving eroded material. While incoming and outgoing tides produce currents in opposite directions on a daily basis, the current in one direction is usually stronger than in the other, resulting in a net one-way transport of sediment. Longshore currents and tidal currents in combination with waves will determine the net direction of sediment transport and ultimately where sediment is eroded and deposited along the shoreline.

Many kinds of depositional landforms are possible along coasts depending on the geological configuration of the coastline, direction of sediment transport, character of the waves, and shape and steepness of the underwater slope offshore. Some common depositional forms are **spits**, **bayhead beaches**, **barrier beaches** or **islands**, **tombolos**, **hooked spits**, **salients**, **bayside beaches**, **lagoons**, and **sandy marshes** (Figure 23.3).

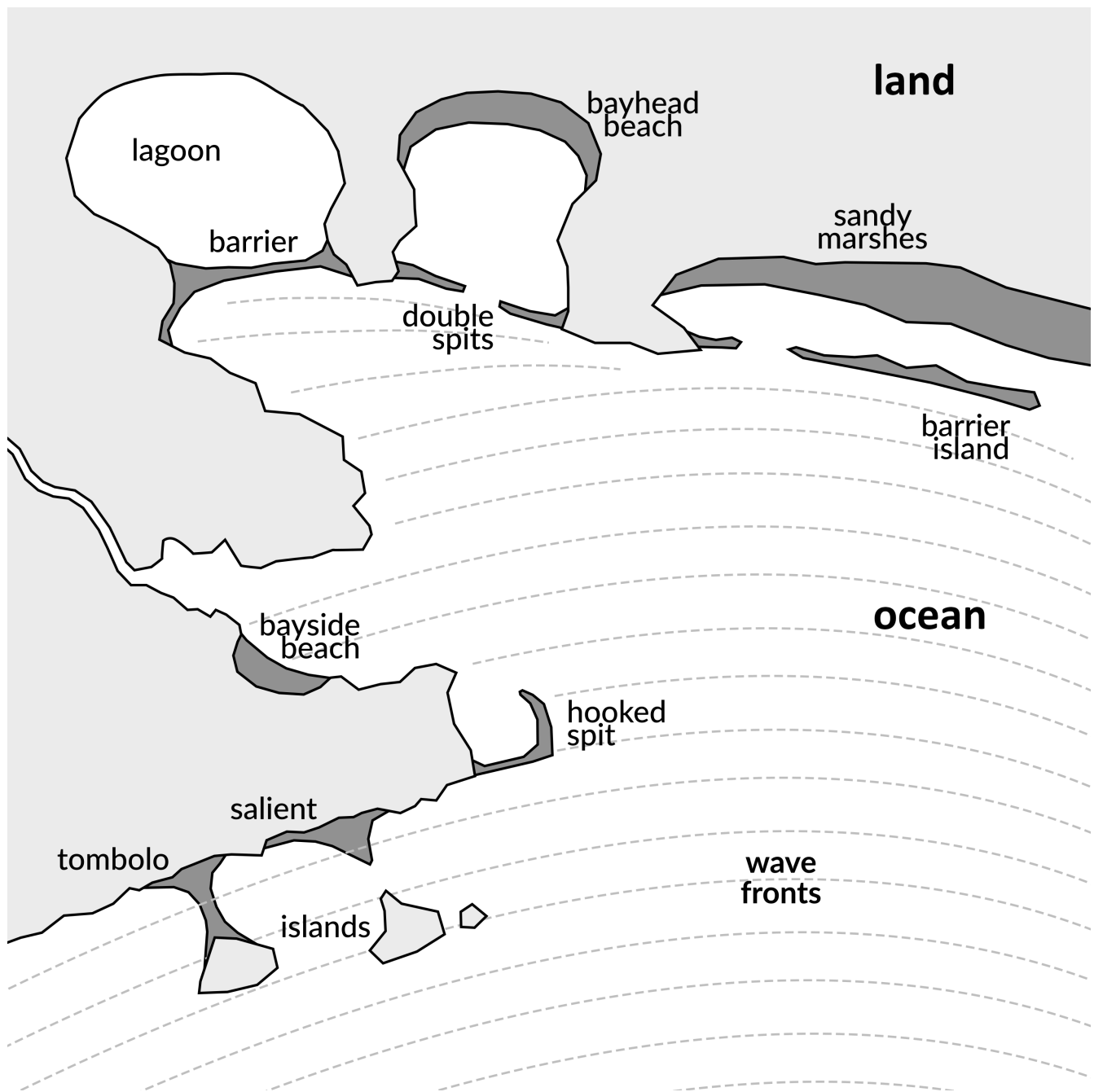


Figure 23.3. Depositional landforms on coasts. Source: M. Oddo, CC BY-NC-SA 4.0.

When specifying the direction of coastal sediment transport, we specify the direction that sediment is moving **towards**. For example, if sediment is moving from Los Angeles, USA, to Vancouver, Canada, then the direction it is moving is north. Cardinal directions are the points on the compass used to specify general direction, and include north (N), south (S), east (E) and west (W), and their derivatives. For further details, refer to Lab 15 Directions.

Coastal Sediment Budgets

Coastal sediment budgets are used to understand changes in beaches and coastlines over time. When

constructing a sediment budget, a geomorphologist will try to quantify (measure or estimate) the inputs, outputs and changes in storage within a coastal compartment referred to as a **littoral cell**. The concept of a littoral cell is to a coastal geomorphologist what a watershed or drainage basin is to a hydrologist – it is an easily identified system of study with natural boundaries.

For a beach system, the sediment budget is generally concerned with sand-sized particles (0.2 – 2 millimetre (mm) diameter) and larger (> 2 mm diameter). The inputs and outputs of a beach sediment budget may consist of some or all of the components listed in Table 23.1. It is important to note that there are a number of locations/processes that can act as sources or sinks of sediment, depending on the local geography and time period of interest. This explain why coastal dunes are listed as inputs **and** outputs: the dune may contribute sediment to the beach (input) or be built up by sand transported from the beach (output). Inputs can come in the form of point sources (e.g., river) or line sources (e.g., cliff erosion).

Table 23.1. Potential inputs and outputs for a coastal sediment budget.

Inputs	Outputs
Littoral drift in	Littoral drift out
Rivers	Offshore transport
Coastal dunes	Coastal dunes
Inlets/lagoons	Inlets/lagoons
Estuaries	Estuaries
Beach nourishment	Dredging
Cliff erosion	Sand mining
Shellfish and sea grass beds	–
Coral reefs	–

Inputs and outputs are commonly expressed as volumetric rates of sediment movement (e.g., cubic metres per year, m³/y).

When inputs are greater than outputs over some period of time, a beach will grow (prograde, storage is positive). When outputs are greater than inputs, the beach will shrink (erode, storage is negative). What will happen when inputs equal outputs? That's correct, the beach will stay the same size. The net sediment budget is equivalent to the change in storage and is (Equation 23.2):

Equation 23.2

$$\Delta\text{Storage} = \text{Inputs} - \text{Outputs}$$

For example, let us assume that each year Bondi Beach receives 70,000 m³/y of sand from littoral drift and 5,000 m³/y from coastal dunes, and loses 79,000 m³/y of sand to littoral drift. The net sediment budget is (Equation 23.2):

$$\Delta\text{Storage} = \text{Inputs} - \text{Outputs}$$

$$\Delta\text{Storage (m}^3/\text{y)} = (70,000 \text{ m}^3/\text{y} + 5,000 \text{ m}^3/\text{y}) - (79,000 \text{ m}^3/\text{y})$$

$$\Delta\text{Storage (m}^3/\text{y)} = 75,000 \text{ m}^3/\text{y} - 79,000 \text{ m}^3/\text{y}$$

$$\Delta\text{Storage (m}^3/\text{y)} = -4,000 \text{ m}^3/\text{y}$$

Because the change in storage is negative, this calculation indicates that Bondi Beach is shrinking at a rate of $4,000 \text{ m}^3/\text{y}$. Don't worry, this calculation is fictional. The beach will still be there when you finally make it to check out the location of Bondi Rescue. When solving this equation, remember your **order of operations**. First add all the components inside the brackets and then subtract the outputs.

Note that the units we are using are a rate, just as velocity is a rate. This means that this relationship can be rearranged to solve for volume of sand or time, depending on which variables are known.

Sea Level Change

Sea level is not constant through time or space. When sea level falls, the coastline moves in an oceanward direction. When sea level rises, the coastline moves in a landward direction. Figure 23.4 shows changes in global sea level over the past 150,000 years.

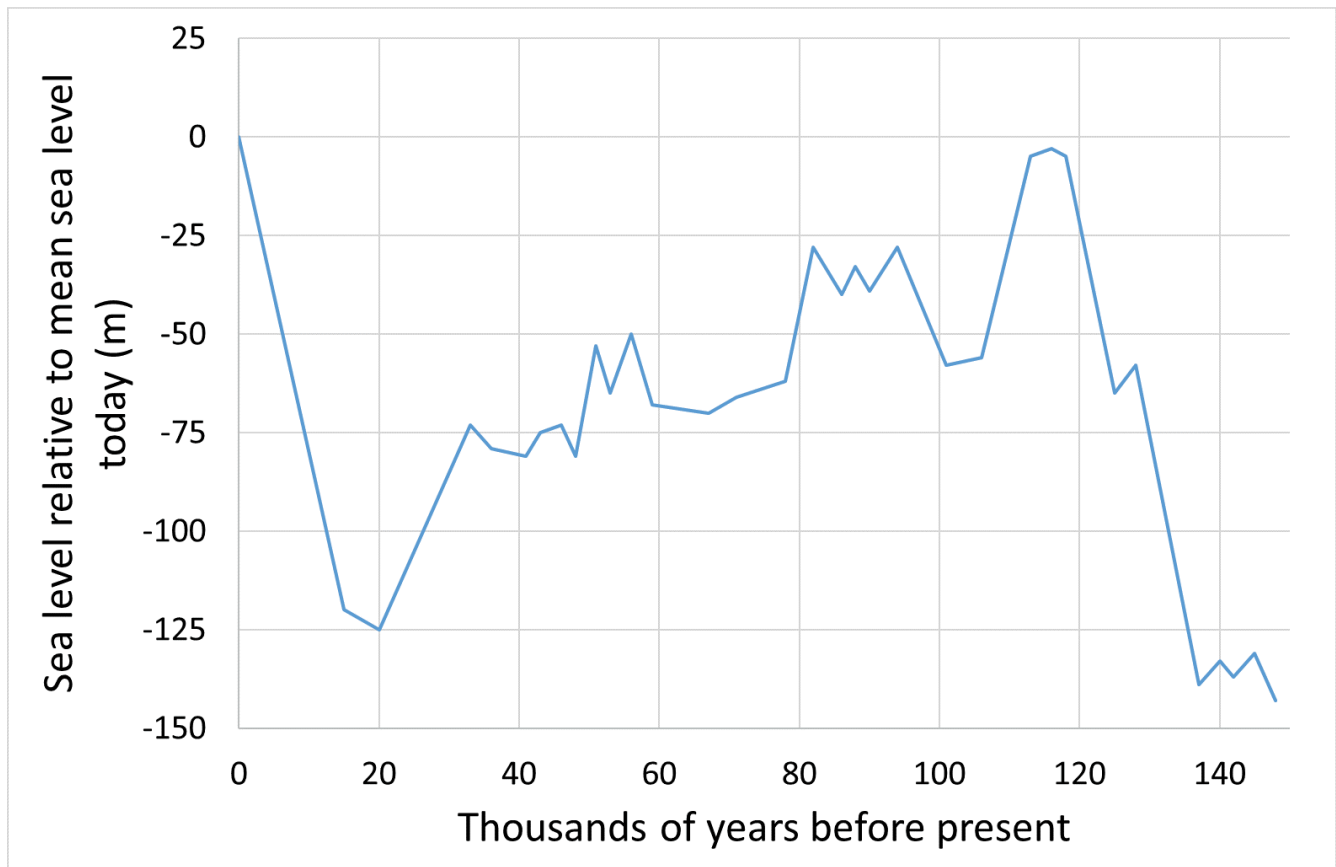


Figure 23.4. Change in global mean sea level over the past 150,000 years. Note that mean sea level today is 0 m on the y axis. Data derived from Shackleton (1987). Source: S. MacKinnon and C. Welch, CC BY-NC-SA 4.0.

A number of processes contribute to changes in sea level both globally and locally:

- Growth and decay of glaciers and ice sheets affect the amount of liquid water.
- Land surface elevations change through time due to plate tectonics.
- Local land surface elevation changes due to melting of overlying glaciers (isostatic adjustment).
- Rise or fall of water level due to heating and cooling of water that leads to expansion and contraction of water in terms of total volume in the oceans.

Bathymetric maps show the topography (depth) of the land surface below the water level in the same way that a topographic map shows the topography (elevation) of hills and mountains. On bathymetric maps, contour lines connect points of equal depth below present sea level.

Lab Exercises

This lab includes a number of exercises to help build your understanding of coastal processes. In this lab you will:

- Calculate wave characteristics based on different types of input data.

- Identify the direction and source of coastal sediment transport from satellite imagery.
- Identify coastal landforms from satellite imagery.
- Calculate coastal sediment budgets.
- Interpret sea level change from graphs and depict spatially on a map.

You will need access to Google Earth (Web) (<https://earth.google.ca>) and Google Earth Engine Timelapse (<https://earthengine.google.com/timelapse/>). If you wish to complete mapping exercises by hand, you will also need the ability to scan or photograph an image and create a PDF. These exercises will take 2-2.5 hours to complete. Submit your work following the instructions of your professor or lab instructor.

EX1: Properties of Waves

1. Calculate the following wave characteristics. Assume the waves are in deep water and include the correct units in your answer. Show your work.
 - a. $P = 12 \text{ s}$, $V = 5.3 \text{ m/s}$, $L =$ _____
 - b. $P = 24 \text{ s}$, $L = 45 \text{ m}$, $V =$ _____
 - c. $L = 4.5 \text{ m}$, $V = 1.6 \text{ m/s}$, $P =$ _____
2. Sitting on a beach, you count 20 waves break in a three-minute period and estimate the wavelength to be 46 feet. What is the wave velocity (in m/s)? Note that $1 \text{ m} = 3.281 \text{ feet}$. Provide your answer correct to one decimal place. Show your work.

EX2: Coastal Sediment Transport

Figure 23.5 shows James Island, which is located off the east coast of Vancouver Island, BC.



(<https://pressbooks.bccampus.ca/geoglabmanualv2/wp-content/uploads/sites/1340/2020/07/figure-23.6-GEweb-version.png>)

Figure 23.5. Google Earth (Web) (<https://earth.google.com/web/>) image of James Island, BC, Canada showing evidence of longshore drift [location: 48°35'60"N 123°21'29"W]. North is indicated by the top half of the double-ended arrow in the bottom-right of the screen. Source: Used in accordance with Google Earth terms and conditions. [Click to view image full size]

3. What is the cardinal direction of coastal sediment transport on James Island (Figure 23.5)? What evidence leads you to that conclusion?
4. What is the source of the sediment being moved along the coast? Open Google Earth (Web) (<https://earth.google.com/web/>) and enter the coordinates provided in the caption of Figure 23.5 to have a closer look around James Island.
5. View the Google Earth Engine Timelapse (<https://earthengine.google.com/timelapse#v=34.63095,-76.47419,9.924,latLng&t=3.43&ps=50&bt=19840101&et=20181231&startDwell=0&endDwell=0>) for the spit at 34.63095°, -76.47419°. What is the cardinal direction of longshore drift?

EX3: Coastal Landforms

Figure 23.6 shows a number of coastal landforms near Tofino, BC.



(<https://pressbooks.bccampus.ca/geoglabmanualv2/wp-content/uploads/sites/1340/2021/03/21.7-Google-Earth-Image-of-Coastal-Landforms-Near-Tofino.png>)

Figure 23.6. Google Earth image of coastal landforms near Tofino, BC, Canada [location: 49°06' N, 125°53' W]. North is indicated by the N in the top-right corner of the image. Source: Adapted by T. Redding. Used in accordance with Google Earth terms and conditions. [Click to view image full size]

6. Identify the coastal landforms labelled A, B, and C on Figure 23.6.
7. Explain how feature A likely formed.
8. What is the dominant direction of incoming waves on Figure 23.6? What is your evidence for this?
9. Locate the following features on Google Earth (Web) (<https://earth.google.com/web/>) by copying and pasting the coordinates or name into the **Search** tool (**magnifying glass** icon, second from top in list on left of screen). Answer the associated questions.
 - a. 21°19'59"N, 158°07'25"W.
 - i. Are these natural or artificial bays? How can you tell?
 - ii. What geomorphic role do the little islands play at the mouth of the bays?
 - b. 21°16'24"N, 157°49'29"W.
 - i. What are these features?

- ii. What purpose do they serve?
- c. The islands of Bora Bora and Tahaa, French Polynesia.
 - i. What type of coastal landform are these features?
 - ii. Which island is older? Explain your evidence for this.
 - iii. What will they eventually become?

EX4: Beach Sediment Budgets

A sediment budget was developed for Sandy Beach in the 1960s. Figure 23.7 is a schematic of the area and includes the boundary of the littoral cell (dashed line) and inputs and outputs.

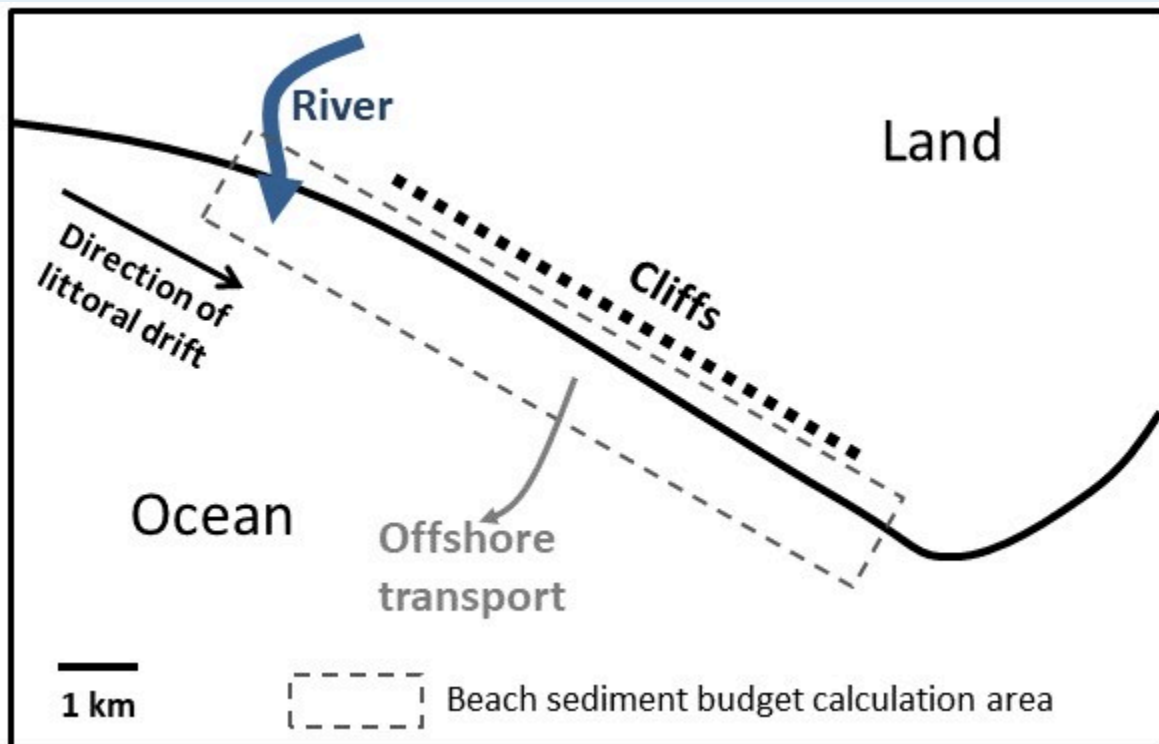


Figure 23.7. Schematic of Sandy Beach sediment budget components. Source: T. Redding, CC BY-NC-SA 4.0.

Volumetric rates of inputs and outputs are provided in Table 23.2.

Table 23.2. Sandy Beach sediment budget.

Inputs	Sand volume (m³/y)
Littoral drift	5,000
Sandy River	123,000
Cliff erosion	42,000
Outputs	Sand volume (m³/y)
Littoral drift	145,000
Offshore transport	18,000

10. Based on the data in Table 23.2, calculate the net sediment budget in the 1960s. Show your work.
11. During the 1960s, was the beach growing, shrinking or staying the same?

In the 1970s and 1980s a number of multi-millionaires built mansions on the top of the cliffs above the beach. The owners were worried about their homes falling into the ocean due to erosion of the cliffs, and constructed revetments along the cliff base. As a consequence, cliff erosion was reduced to 20,000 m³/y. Erosion wasn't completely stopped because a section of the cliff was managed by a Coastal Conservancy that did not want to build revetments. Thus, certain portions of the cliff remained natural and unprotected.

12. It is now the year 2021, and the effects of the decrease in cliff erosion are starting to become evident.
 - a. Re-calculate the net sediment budget considering the change in cliff erosion. Show your work.
 - b. Is the beach now growing, shrinking, or staying the same?
 - c. Will erosion or deposition be uniformly distributed along the entire length of shoreline backed by the cliff? Explain.

Changes in the sediment budget affect the width of the beach (beach distance from cliffs to sea level) over a period of years to decades. A coastal engineer has predicted that a positive sediment budget of 5,000 m³/y would add 0.1 m to the width of the beach, while a loss of 5,000 m³/y results in a decrease of 0.1 m to the width of the beach.

13. Assume that the beach had an average width of 35 m prior to the construction of the revetments. How **long** did it/will it take for the beach to recede (erode) back to the base of the cliff? **Hint:** Use the net sediment budget you calculated in Q12a.

EX5: Sea Level Change

14. Use Figure 23.4 to determine how sea level has changed through time. Approximately how high

was the sea level (compared to today's sea level) in metres:

- a. 18,000 years ago?
 - b. 40,000 years ago?
 - c. 90,000 years ago?
 - d. 140,000 years ago?
15. Download and print out or open the **Shoreline Bathymetric Map** provided in Worksheets. On this map:
- a. Draw the coastline where it would have been at each time listed in Q14. Draw each coastline in a different colour or with a different line symbol.
 - b. Fill in the key to indicate which colour and/or line symbol matches which time.

Scan or photograph your completed map (in colour) if you drew the coastlines by hand. Save it to a known location on your computer.

16. The two stars on the Shoreline Bathymetric Map show the locations of ancient village sites where Coast Salish people lived when sea level was lower. The remains of intricate fish traps are further evidence that people at these sites lived at an ancient coastline and survived on a diet of fish. Given your knowledge of the changing sea level from the graph above, estimate the age of these archeological sites.

Reflection Questions

1. What happens when a wave approaches shore and why?
2. Considering coastal sediment transport (erosion and deposition), describe the ideal location to build your dream beach front home.
3. What is the best method of protecting built structures along the shoreline from wave erosion and why?
4. What are the seabed and wave characteristics that result in good waves for surfing and why?

Worksheets

Back to EX6

Shoreline Bathymetric Map

- Shoreline Bathymetric Map [PNG] (<https://pressbooks.bccampus.ca/geoglabmanualv2/wp-content/uploads/sites/1340/2020/07/Shoreline-Bathymetric-Map.png>)

- Shoreline Bathymetric Map [WORD] (<https://pressbooks.bccampus.ca/geoglabmanualv2/wp-content/uploads/sites/1340/2020/07/Shoreline-Bathymetric-Map.docx>)
- Shoreline Bathymetric Map [ODT] (<https://pressbooks.bccampus.ca/geoglabmanualv2/wp-content/uploads/sites/1340/2020/07/Shoreline-Bathymetric-Map.odt>)
- Shoreline Bathymetric Map [PDF] (<https://pressbooks.bccampus.ca/geoglabmanualv2/wp-content/uploads/sites/1340/2020/07/Shoreline-Bathymetric-Map.pdf>)

References

Davidson-Arnott, R., Bauer, B., & Houser, C. (2019). *Introduction to Coastal Processes and Geomorphology* (2nd ed.). Cambridge University Press, New York, NY.

Shackleton, N.J. (1987). Oxygen isotopes, ice volume and sea level ([https://doi.org/10.1016/0277-3791\(87\)90003-5](https://doi.org/10.1016/0277-3791(87)90003-5)). *Quaternary Science Reviews*, 6(3-4), 183-190.

Lab 24: South Okanagan Geomorphology Virtual Field Trip

Chani Welch and Todd Redding

The South Okanagan is generally defined as the portion of the Okanagan Valley from Peachland south to the international border with the USA (Figure 24.1). It is unique in Canada as it has a climate that is relatively dry and warm. However, the South Okanagan has not always had this climate. British Columbia was formed through repeated violent collisions of the Pacific and North American tectonic plates. Volcanic activity, changing climates, and continued tectonic plate movements have all left their mark on the Okanagan Valley.

This lab explores the formation of specific landforms. In doing so, it reviews many of the major geomorphic processes that shape our Earth. Here in the South Okanagan, we visit landscape features that were created by plate tectonics, volcanic activity, weathering, mass movement, fluvial and glacial processes, and often a combination thereof. Welcome to this dynamic area.

Learning Objectives

After completion of this lab, you will be able to:

- Identify the geomorphic process responsible for the formation of landscape features.
- Match theoretical concepts of landscape formation with local examples.
- Use Google Earth to identify landscape features.

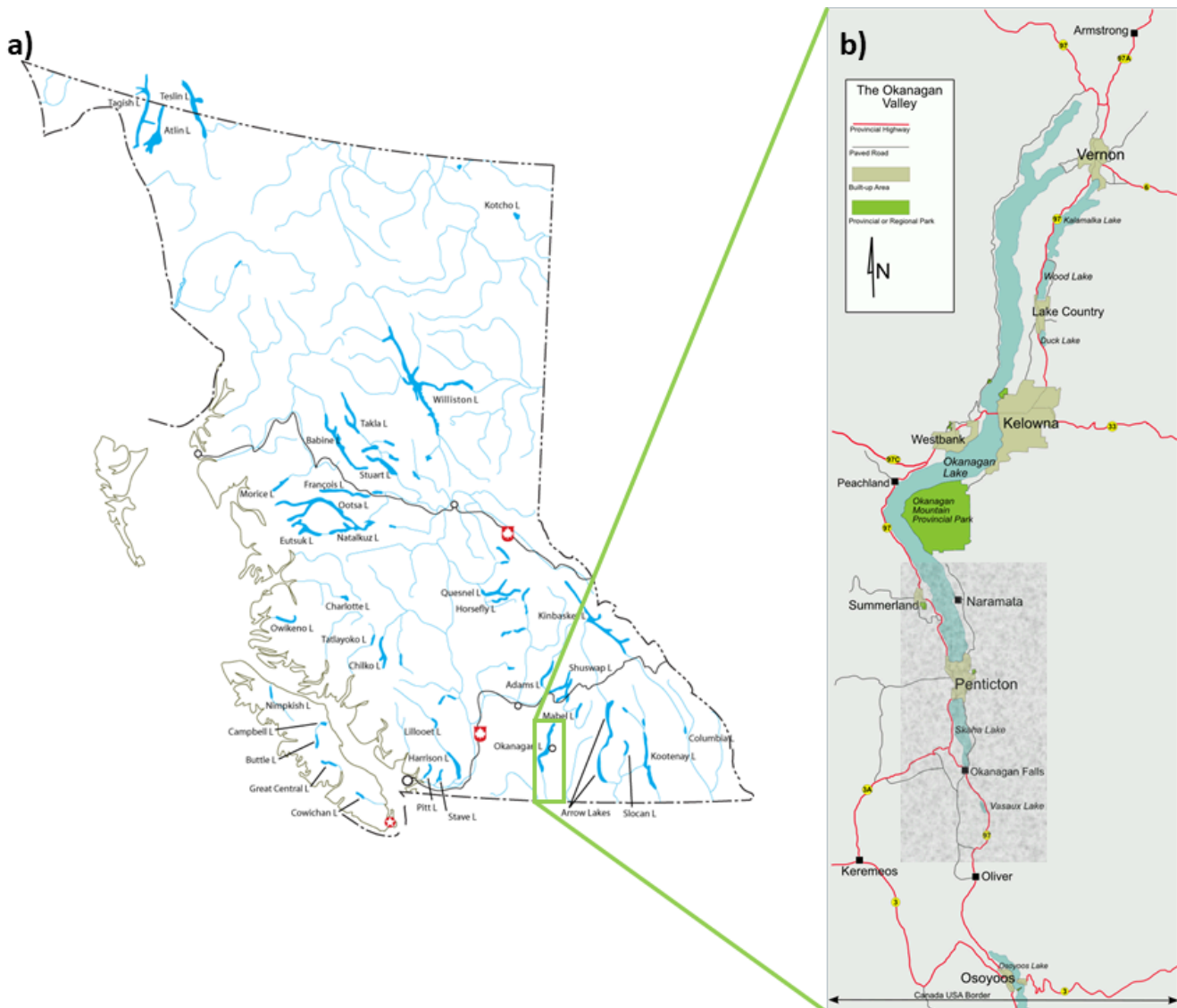
Pre-Readings

In order to complete this lab, a theoretical understanding of major geomorphic processes is assumed. It is likely that you have already covered these topics in your geography course. If not, then any introductory physical geography text will explain the major processes of landscape formation. For example, a general introduction to Earth science and geomorphologic processes is contained in Earle (2020) *Physical Geology – 2nd Edition* (<https://opentextbc.ca/physicalgeology2ed/>). Key areas that you may wish to review are

- plate tectonics, volcanoes, and mountain building,
- faults and geologic cross sections,
- erosional and depositional landforms created by glacier movement,
- weathering and rock slides, and

- watershed hydrology, river types, fluvial landforms.

The location of the South Okanagan is depicted on Figure 24.1.



(<https://pressbooks.bccampus.ca/geoglabmanualv2/wp-content/uploads/sites/1340/2020/07/figure-22.1.png>)

Figure 24.1. Location maps of a) the Okanagan Valley within British Columbia and b) the area explored in this virtual field trip (shaded) within the Okanagan Valley. Source: a) Feydey (2005), CC BY-SA (Canada BC lakes map.png (https://commons.wikimedia.org/wiki/File:Canada_BC_lakes_map.png)) adapted from Natural Resources Canada. b) Bulliver (2007), CC BY-SA (Okanagan Valley.png (https://commons.wikimedia.org/wiki/File:Okanagan_valley.png)). [Click to view image full size]

Lab Exercises

In this lab we will visit ten locations throughout the South Okanagan and discuss their formation. The features were created by plate tectonics, volcanic activity, glacial and fluvial processes, weathering and mass movement.

This lab consists of two exercises and should take 1.5 to 2 hours to complete. The first exercise consists of completing the field trip in Google Earth (Web). In the second exercise you will interpret and reflect on what you have seen and heard in the videos.

EX1: Virtual Field Trip via Google Earth (Web)

The preferred method of completing this field trip is through Google Earth (Web) in order to provide the geographic context for each stop. You are encouraged to take a look around in Google Earth (Web) to familiarize yourself with the area in which the field trip takes place, and put it in context with your understanding or experience of British Columbia specifically, and Canada in general.

Introductory notes for each group of stops and each individual stop are provided below. Individual links to the videos for each field stop are provided with these introductory notes in the event that Google Earth (Web) is inaccessible. Transcript available: [Word] (https://pressbooks.bccampus.ca/geoglabmanualv2/wp-content/uploads/sites/1340/2021/08/Lab-24-Transcript_Full.docx) [ODT] (https://pressbooks.bccampus.ca/geoglabmanualv2/wp-content/uploads/sites/1340/2021/08/Lab-24-Transcript_Full.odt) [PDF] (https://pressbooks.bccampus.ca/geoglabmanualv2/wp-content/uploads/sites/1340/2021/08/Lab-24-Transcript_Full.pdf)

In order to access the field trip:

Step 1: Download the Virtual Field Trip [KML file] (<https://drive.google.com/file/d/1-SoNam2sJtHlHKfQojgVSQKNxIWWC-q/view?usp=sharing>) from Worksheets and save it to a known location on your computer.

Step 2: Open Google Earth (Web) (<https://earth.google.com/web/>).

Step 3: Click on the **Projects** icon in the menu bar on the left of the screen (placemark in a square).

Step 4: Select **New project**, then **Import KML file from computer**. Select the KML file and click **Open**.

Step 5: The Virtual Field Trip will open. You will see the tour summary in the information panel on the left side of your screen. Click **Present** to start the tour.

Step 6: Google Earth will zoom you in to the area of the field trip stop. A box will pop up in the top-right corner of your screen with the video. Click the **arrow indicating play** and watch the video.

Step 7: When you are finished watching the video for the stop, click on the forward > arrow in the bottom-left of the screen to move to the next stop. Note that the view does not change when you transition from Stop 1 to Stop 2 because Stop 2 is already in your view. For remaining stops, you will **zoom** to the new location. Watch the new video that appears in the top-right corner.

Step 8: Repeat Step 7 until you have completed all 12 stops on the field trip. You can also move through the field trip by expanding the **Table of Contents** located in the bottom-left of the screen.

Let's Begin!

Stop 1: Introduction

In Video 24.1 we welcome to this virtual field trip of geomorphology of the South Okanagan.

We respectfully acknowledge that this field trip takes place on the traditional and unceded territory of the Syilx Okanagan people who have taken care of their homelands for thousands of years. To learn more about the Syilx Okanagan people, their homelands, governance, and of special interest to this field trip, their relationship to water, please visit the Syilx Okanagan Nation Alliance website (<https://www.syilx.org/>).

Video 24.1. Stop 1. Introduction (<https://www.youtube.com/watch?v=jbkc6f6K1Ok>). Transcript available: [Word] (https://pressbooks.bccampus.ca/geoglabmanualv2/wp-content/uploads/sites/1340/2021/08/Stop-1-Introduction_V1.docx) [ODT] (https://pressbooks.bccampus.ca/geoglabmanualv2/wp-content/uploads/sites/1340/2021/08/Stop-1-Introduction_V1.odt) [PDF] (https://pressbooks.bccampus.ca/geoglabmanualv2/wp-content/uploads/sites/1340/2021/08/Stop-1-Introduction_V1.pdf)



One or more interactive elements has been excluded from this version of the text. You can view them online here: <https://pressbooks.bccampus.ca/geoglabmanualv2/?p=314#oembed-1> (#oembed-1)

Plate Tectonics and Volcanoes

Plate tectonics explains how and why continents can move around Earth, forming and reforming over time. Consequently, it also explains why volcanoes and mountain ranges are located where they are, and why earthquakes occur where they do.

Stop 2: Munson Mountain (Video 24.2)

In order to understand the formation of the Okanagan Valley, we need to begin with the formation of BC. We begin our tour on Munson Mountain, a little-known volcanic feature, and an excellent viewpoint. In Video 24.2 we discuss the accretion of terrains, crustal relaxation, volcanic activity, and the Okanagan Fault, to learn why the valley exists where and as it does.

Video 24.2. Stop 2. Munson Mountain (<https://www.youtube.com/watch?v=zE4KF-Bc4pQ>). Transcript available: [Word] (https://pressbooks.bccampus.ca/geoglabmanualv2/wp-content/uploads/sites/1340/2021/08/Stop-2-Munson-Mountain_V1.docx) [ODT] (https://pressbooks.bccampus.ca/geoglabmanualv2/wp-content/uploads/sites/1340/2021/08/Stop-2-Munson-Mountain_V1.odt) [PDF] (https://pressbooks.bccampus.ca/geoglabmanualv2/wp-content/uploads/sites/1340/2021/08/Stop-2-Munson-Mountain_V1.pdf)



One or more interactive elements has been excluded from this version of the text. You can view them online here: <https://pressbooks.bccampus.ca/geoglabmanualv2/?p=314#oembed-2> (#oembed-2)

Glacial Processes

Glaciers have played a major role in shaping the Canadian landscape, and the South Okanagan is no exception. Glaciers are sometimes referred to as nature's bulldozers. Glaciers rework the landscape as they advance, creating erosional features with distinctive shapes, and as they retreat, leave behind sediments to create unique depositional features. The presence and orientation of these landscape features are used to interpret the direction and extent of glacier movement.

Stop 3: Giants Head

The shape of Giants Head is the key to understanding how this volcanic remnant we view in Video 24.3 was reshaped by glaciers moving south through the Okanagan Valley. It is one example of a roche moutonnée (literal translation, sheep back). There are many other examples nearby.

Video 24.3. Stop 3. Giants Head (<https://www.youtube.com/watch?v=zKFJ62omEGI>). Transcript available: [Word] (https://pressbooks.bccampus.ca/geoglabmanualv2/wp-content/uploads/sites/1340/2021/08/Stop-3-Giants-Head_V1.docx) [ODT] (<https://pressbooks.bccampus.ca/geoglabmanualv2/wp-content/>)

uploads/sites/1340/2021/08/Stop-3-Giants-Head_V1.odt) [PDF] (https://pressbooks.bccampus.ca/geoglabmanualv2/wp-content/uploads/sites/1340/2021/08/Stop-3-Giants-Head_V1.pdf)



One or more interactive elements has been excluded from this version of the text. You can view them online here: <https://pressbooks.bccampus.ca/geoglabmanualv2/?p=314#oembed-3> (#oembed-3)

Stop 4: A Glacial Erratic

One definition of erratic is to move in an irregular fashion, at unexpected times, or at the least, to not follow a regular pattern. Appreciate the power of ice and the awesome randomness of glacial deposition on Campbell Mountain in Video 24.4. Note however, that the position of erratics far from their source rocks has been used to understand the movement of glaciers.

Video 24.4. Stop 4. A Glacial Erratic (<https://www.youtube.com/watch?v=2hVMHvuaiUU>). Transcript available: [Word] (https://pressbooks.bccampus.ca/geoglabmanualv2/wp-content/uploads/sites/1340/2021/08/Stop-4-A-Glacial-Erratic_V1.docx) [ODT] (https://pressbooks.bccampus.ca/geoglabmanualv2/wp-content/uploads/sites/1340/2021/08/Stop-4-A-Glacial-Erratic_V1.odt) [PDF] (https://pressbooks.bccampus.ca/geoglabmanualv2/wp-content/uploads/sites/1340/2021/08/Stop-4-A-Glacial-Erratic_V1.pdf)



One or more interactive elements has been excluded from this version of the text. You can view them online here: <https://pressbooks.bccampus.ca/geoglabmanualv2/?p=314#oembed-4> (#oembed-4)

Stop 5: Till

We don't see a lot of till in the South Okanagan. We will review the mechanisms for transportation and deposition of the different till types, and learn to tell the difference between basal (lodgement) till and ablation till by inspecting grain size distribution at this outcrop near the Penticton Water Treatment Plant in Video 24.5.

Video 24.5. Stop 5. Till (<https://www.youtube.com/watch?v=7JjvNvJMFUE>). Transcript available: [Word] (https://pressbooks.bccampus.ca/geoglabmanualv2/wp-content/uploads/sites/1340/2021/08/Stop-5-Till_V1.docx) [ODT] (https://pressbooks.bccampus.ca/geoglabmanualv2/wp-content/uploads/sites/1340/2021/08/Stop-5-Till_V1.odt) [PDF] (https://pressbooks.bccampus.ca/geoglabmanualv2/wp-content/uploads/sites/1340/2021/08/Stop-5-Till_V1.pdf)



One or more interactive elements has been excluded from this version of the text. You can view them online here: <https://pressbooks.bccampus.ca/geoglabmanualv2/?p=314#oembed-5> (#oembed-5)

Stop 6: Glacial Lake Penticton from the Kettle Valley Railway

The Kettle Valley Railway (KVR) once ran from Midway to Hope, with one arm that ran up the east side of Okanagan Lake. The railway ceased to operate in 1961, and has been turned into a multi-use recreational

trail. At this stop, we dive back into the icy waters of Glacial Lake Penticton by inspecting glacial lacustrine deposits on the side of the trail.

Video 24.6. Stop 6. Glacial Lake Penticton from the Kettle Valley Railway (<https://www.youtube.com/watch?v=vOIRa1qFfgQ>). Transcript available: [Word] (https://pressbooks.bccampus.ca/geoglabmanualv2/wp-content/uploads/sites/1340/2021/08/Stop-6-Glacial-Lake-Penticton-from-the-KVR_V1-.docx) [ODT] (https://pressbooks.bccampus.ca/geoglabmanualv2/wp-content/uploads/sites/1340/2021/08/Stop-6-Glacial-Lake-Penticton-from-the-KVR_V1-.odt) [PDF] (https://pressbooks.bccampus.ca/geoglabmanualv2/wp-content/uploads/sites/1340/2021/08/Stop-6-Glacial-Lake-Penticton-from-the-KVR_V1-.pdf)



One or more interactive elements has been excluded from this version of the text. You can view them online here: <https://pressbooks.bccampus.ca/geoglabmanualv2/?p=314#oembed-6> (#oembed-6)

Weathering and Mass Movement

Weathering is the breakdown of rock. Mass movement is the downslope movement of rock and/or sediments. Time scale is critical to understanding the rates of these processes.

Stop 7: Weathering

In the hills above Penticton, investigate different ways that water, vegetation, and time break down rock in Video 24.7.

Video 24.7. Stop 7. Weathering (<https://www.youtube.com/watch?v=F2YRZCr1XHQ>). Transcript available: [Word] (https://pressbooks.bccampus.ca/geoglabmanualv2/wp-content/uploads/sites/1340/2021/08/Stop-7-Weathering_V1-.docx) [ODT] (https://pressbooks.bccampus.ca/geoglabmanualv2/wp-content/uploads/sites/1340/2021/08/Stop-7-Weathering_V1-.odt) [PDF] (https://pressbooks.bccampus.ca/geoglabmanualv2/wp-content/uploads/sites/1340/2021/08/Stop-7-Weathering_V1-.pdf)



One or more interactive elements has been excluded from this version of the text. You can view them online here: <https://pressbooks.bccampus.ca/geoglabmanualv2/?p=314#oembed-7> (#oembed-7)

Stop 8: Summerland Rock Slide 2019.

In early February, 2019, Highway 97C was closed north of Summerland for 10 days by a rockslide. A motorist present captured the major rockfall on camera from the safety of their car. Rock slides in this area are not uncommon due to multiple small faults in the rock. Watch the action and join UBC Okanagan engineering professor Dwayne Tannant for an assessment mid-way through the drama. Ultimately, approximately 20,000 m³ of rock was removed from the site over the following months. Monitoring of slope movement continues.

To access this field trip stop, read the local news article Slope still posing a threat (<https://www.castanet.net/news/Kelowna/248803/slope-still-posing-a-threat>) and watch the video included in the article.

Transcript available: [Word] (https://pressbooks.bccampus.ca/geoglabmanualv2/wp-content/uploads/sites/1340/2021/08/Stop-8-Summerland-Rock-Slide-2019_V1.docx) [ODT] (https://pressbooks.bccampus.ca/geoglabmanualv2/wp-content/uploads/sites/1340/2021/08/Stop-8-Summerland-Rock-Slide-2019_V1.odt)

[PDF] (https://pressbooks.bccampus.ca/geoglabmanualv2/wp-content/uploads/sites/1340/2021/08/Stop-8-Summerland-Rock-Slide-2019_V1.pdf)

Fluvial Processes

Fluvial processes have dominated geomorphic change since the last glaciation. As with glaciers, fluvial systems both erode and deposit material, creating erosional and depositional landforms. A critical difference between glaciers and rivers in terms of deposition, is that rivers sort material based on weight (grain size), whereas glaciers do not.

Stop 9: Why Penticton Is Located Where It Is

Perched high above the valley bottom, we look down at the City of Penticton in Video 24.8, and learn how the coincidental discharge of three fluvial systems at this one narrow point in Okanagan Lake led to the formation of the alluvial fan delta on which Penticton is located. This feature separates Okanagan Lake and Skaha Lake.

Video 24.8. Stop 9. Why Penticton Is Located Where It Is (<https://www.youtube.com/watch?v=BAXH5kF9Jsk>). Transcript available: [Word] (https://pressbooks.bccampus.ca/geoglabmanualv2/wp-content/uploads/sites/1340/2021/08/Stop-9-Why-Penticton-is-Located-Where-it-is_V1.docx) [ODT] (https://pressbooks.bccampus.ca/geoglabmanualv2/wp-content/uploads/sites/1340/2021/08/Stop-9-Why-Penticton-is-Located-Where-it-is_V1.odt) [PDF] (https://pressbooks.bccampus.ca/geoglabmanualv2/wp-content/uploads/sites/1340/2021/08/Stop-9-Why-Penticton-is-Located-Where-it-is_V1.pdf)



One or more interactive elements has been excluded from this version of the text. You can view them online here: <https://pressbooks.bccampus.ca/geoglabmanualv2/?p=314#oembed-8> (#oembed-8)

Stop 10: Penticton Dam and The Channel

In Video 24.9 we will explore the hydrology of the South Okanagan, including the drastic changes to the Okanagan River in the past 70 years. We will also learn how to identify historical floodplain features in current images.

Video 24.9. Stop 10. Penticton Dam and The Channel (<https://www.youtube.com/watch?v=d0E0qCgQ9uw>). Transcript available: [Word] (https://pressbooks.bccampus.ca/geoglabmanualv2/wp-content/uploads/sites/1340/2021/08/Stop-10-Penticton-Dam-The-Channel_V1.docx) [ODT] (https://pressbooks.bccampus.ca/geoglabmanualv2/wp-content/uploads/sites/1340/2021/08/Stop-10-Penticton-Dam-The-Channel_V1.odt) [PDF] (https://pressbooks.bccampus.ca/geoglabmanualv2/wp-content/uploads/sites/1340/2021/08/Stop-10-Penticton-Dam-The-Channel_V1.pdf)



One or more interactive elements has been excluded from this version of the text. You can view them online here: <https://pressbooks.bccampus.ca/geoglabmanualv2/?p=314#oembed-9> (#oembed-9)

Stop 11: White Lake Formation

Take a trip back in time to the Eocene through the lens of the White Lake Formation rocks in Video 24.10 and experience a warmer, wetter climate and large paleoriver systems dominating the Okanagan.

Video 24.10. Stop 11. White Lake Formation (<https://www.youtube.com/watch?v=SIBwl0VqpKo>).

Transcript available: [Word] (https://pressbooks.bccampus.ca/geoglabmanualv2/wp-content/uploads/sites/1340/2021/08/Stop-11-White-Lake-Formation_V1.docx) [ODT] (https://pressbooks.bccampus.ca/geoglabmanualv2/wp-content/uploads/sites/1340/2021/08/Stop-11-White-Lake-Formation_V1.odt) [PDF] (https://pressbooks.bccampus.ca/geoglabmanualv2/wp-content/uploads/sites/1340/2021/08/Stop-11-White-Lake-Formation_V1.pdf)



One or more interactive elements has been excluded from this version of the text. You can view them online here: <https://pressbooks.bccampus.ca/geoglabmanualv2/?p=314#oembed-10> (#oembed-10)

And finally...**Stop 12: Wrap Up**

Thank you for joining the virtual field trip. Here in Video 24.11 we summarize the processes that created the Okanagan Valley as we see it today.

Video 24.11. Stop 12. Wrap Up (<https://www.youtube.com/watch?v=CLcJaP30tqw>). Transcript available: [Word] (https://pressbooks.bccampus.ca/geoglabmanualv2/wp-content/uploads/sites/1340/2021/08/Stop-12-Wrap-Up_V1.docx) [ODT] (https://pressbooks.bccampus.ca/geoglabmanualv2/wp-content/uploads/sites/1340/2021/08/Stop-12-Wrap-Up_V1.odt) [PDF] (https://pressbooks.bccampus.ca/geoglabmanualv2/wp-content/uploads/sites/1340/2021/08/Stop-12-Wrap-Up_V1.pdf)



One or more interactive elements has been excluded from this version of the text. You can view them online here: <https://pressbooks.bccampus.ca/geoglabmanualv2/?p=314#oembed-11> (#oembed-11)

EX2: Interpret What You Have Seen and Learned**Plate Tectonics and Volcanoes**

1. Munson Mountain slid to the west when the Okanagan Fault activated. Is the magma chamber related to Munson Mountain likely to sit directly below it? If not, where is it likely to be?
2. In which general direction does the Okanagan Fault run in the South Okanagan?
3. The types of rocks located west and east of Okanagan Lake are markedly different. Name the two different major rock types and describe their formation in geologic terms.
4. Sketch a cross section of the Okanagan Valley immediately north of Penticton as it would have been prior to glaciation. Label the major rock types, direction of movement along the fault plane, fault type and features (hanging wall, footwall).

Glacial Processes

5. Sketch the general shape of a roche moutonnée. Indicate the direction of ice movement, and the locations of glacial polishing and glacial plucking. Name and describe the process of glacial erosion involved.
6. Glacial erratics are depositional features of post-glacial landscapes.
 - a. Did the glacial erratic originate on Campbell Mountain?
 - b. Was it deposited as glaciers advanced or retreated?
7. Two types of till are visible near the Penticton Water Treatment Plant. Name the two types and describe how glaciers transport and deposit each.
8. In which direction did Glacial Lake Penticton drain? Why?
9. What evidence is there that there was an ice core in the middle of Glacial Lake Penticton?
10. Would you build a house on the silt cliffs? Why/why not?

Weathering and Mass Movement

11. At the start of the Stop 7: Weathering video, Todd describes a type of weathering that involves the growth of a tree. What type of weathering is this? Provide an example of where this occurs in urban environments.
12. In colder environments physical processes tend to dominate weathering. Describe the process by which water freezing and thawing weathers rock.
13. Todd loves geomorphology but is a little camera-shy. How many times did he say **um**, **ah**, **err** in the weathering video? (This question was his idea.)
14. The Summerland Rock Slide was rather inconvenient for people wishing to travel between Penticton and Kelowna.
 - a. What was the largest estimate of moving rock (in m³)? Is this a large volume in comparison to other mass movement events in Canadian history?
 - b. Did the rockslide happen all at once?
 - c. How was the rockslide stabilized?

Fluvial Processes

15. What are the names of the three streams that have deposited sediment to create the ground on which Penticton is located?
16. Why is the feature that Penticton is located on called a fan-delta (specifically a coalescing fan-delta)?
17. Is modern Okanagan Lake a completely natural feature? Explain.
18. What type of river was the Okanagan River before it was channelized?
19. Describe one benefit and one drawback of the dam and channelization. Is it possible to reconcile the two?
20. Describe the difference between an oxbow lake and a meander scar. Are these natural or man-made floodplain features?

21. What evidence is there that the climate was warmer and wetter when the paleoriver system that deposited the White Lake Formation was flowing?
22. Explain why high energy flow regimes deposit coarse sediments and low energy flow regimes deposit fine sediments.

Overview

23. Sketch a modern cross section of the Okanagan Valley immediately north of Penticton. Label the major rock types and the major deposits since the Pleistocene.

Reflection Questions

1. Here are the coordinates for three additional landforms in the South Okanagan. Can you identify what they are, and how and when (pre or post the last glaciation) they were formed? Enter the coordinates into Google Earth (Web) to take yourself there.
 - a. Feature 1: 49°34'19"N and 119°37'58"W (coordinates are in the centre of the feature).
 - b. Features 2 and 3: 49°16'09"N and 119°32'00"W (coordinates sit between the two features (same type)).
2. Using Google Earth, zoom to your area (or an area of interest) in BC. Identify a landscape feature of interest to you. Provide the coordinates. Describe how and when this feature was formed. It may be useful to switch into 3D mode as some features are easier to interpret from a side view rather than a birds-eye view.
3. As discussed on the tour, the major agents for geomorphic change in an area change with time. Volcanoes, glaciers, and fluvial systems have all dominated at different times in the South Okanagan. Many scientists believe that we are now in a new epoch called the Anthropocene. What do you think the major agent for geomorphic change is today? What is your evidence for this? Consider, for example, what you see at 49°28'07"N and 119°33'49"W.

Worksheets

- Virtual Field Trip [KML] (https://drive.google.com/file/d/1-_SoNam2sJtHIHKfjqjgVSQKNxIWWC-q/view?usp=sharing)

References

Earle, S. 2020. *Physical geology, 2nd Edition*. BCcampus. <https://opentextbc.ca/physicalgeology2ed/>

Roed, MA and Fulton, RJ (eds), 2011. *Okanagan geology south, Kelowna, BC*. Okanagan Geology Committee.

About the Authors



(<https://pressbooks.bccampus.ca/geoglabmanualv2/wp-content/uploads/sites/1032/2020/09/Group-Photo.png>)

In this photo (left to right): Top = Gillian Krezoski, Stuart MacKinnon, Allison Lutz, Terence Day; Middle = Craig Nichol, Leonard Tang, Katie Burles, Chani Welch; Bottom = Todd Redding, Nina Hewitt, Crystal Huscroft, Andrew Perkins. Missing from the photo: Fes de Scally and Ian Saunders.

Katie Burles

Katie is a Geography Instructor at the College of the Rockies (COTR), Cranbrook, BC. Her formal education includes a Bachelor of Arts in geography from Thompson Rivers University (2008), Master of Science in geography from University of Lethbridge (2010), and the Provincial Instructors Diploma Program through Vancouver Community College (2017). Before joining the College of the Rockies science faculty, Katie worked as an environmental consultant, public servant, and program manager of a not-for-profit organization. In these roles, she worked on a variety of snow science, fluvial geomorphology, watershed balance, surficial geology, and watershed governance and planning projects. Conducting field-based research and monitoring has provided her with many opportunities to explore remote areas of the Yukon, BC, and Alberta during all four seasons. This only fuels her desire to spend more time in the outdoors and show her students and young sons the wonders of the natural world.

Terence Day

Terry is a Professor in the Department of Geography, Earth and Environmental Science at Okanagan College in Kelowna. Terry holds a B.Sc. in Geography from the University of Wales, Swansea, a M.Sc. in Geographic Information Science from Birkbeck College, University of London, and Ph.D. in

Environmental Science from the University of East Anglia. Terry loves teaching geography, especially face-to-face, but online is good too. He has travelled extensively in the Arctic, East Asia, South America, Australia, Europe, and Africa, and tries to incorporate those experiences into his courses. He is a volunteer firefighter and first responder, and collects old maps. Terry, his wife, and their beautiful golden doodle, all enjoy camping and getting out.

Fes de Scally

Fes holds a B.A. in Geography from Simon Fraser University, a M.Sc. in Geography from the University of Alberta with a thesis on snowpack behavior and avalanche activity in the Rocky Mountains, and a Ph.D. in Geography from the University of Waterloo with a thesis on the effect of widespread snow avalanching on snowmelt processes in the Punjab Himalaya of Khyber Pakhtunkhwa Province, Pakistan. Since 1989, Fes has taught at Okanagan College, Okanagan University College and, since 2005, UBC's Okanagan campus. He retired from UBCO's Department of Earth, Environmental and Geographic Sciences in June of 2020. Fes has spent his career doing field work on a variety of hydrologic and geomorphic research problems in the Punjab Himalaya, Rockies and Cascade Mountains of western Canada, New Zealand's Southern Alps, Swiss Alps, and Australia's Snowy Mountains. Since 2001, he has also worked with the Cook Islands Meteorological Service on tropical cyclone and storm surge hazards in that small South Pacific nation. Over the past 35 years, Fes has taught a wide variety of undergraduate courses in Physical Geography and Natural Hazards, with a focus on mountain environments and experiential field learning.

Nina Hewitt

Nina is an Assistant Professor of Teaching in the Department of Geography at the University of British Columbia, Vancouver. A biogeographer, she researches plant dispersal, migration and disturbance ecology in temperate forests and alpine ecosystems, with field sites in Ontario, British Columbia and the Karakoram-Himalaya. She has published on tree species colonization in fragmented forest systems, assisted migration as a response to species range shifts, fire history reconstruction, and invasive species, among other topics. Her current research focuses on comparing contemporary and historical alpine plant species distributions in the Karakoram-Himalaya, and on building a database of BC alpine plant species. She has a strong interest in practical applications of her research, for example to inform biodiversity management in increasingly fragmented landscapes; policy responses to climate change, and prescribed burn practices. Nina also brings her enthusiasm for biogeography and ecology to her teaching. She is developing a series of immersive Augmented and Virtual Reality field trips as a way to engage learners in the biogeosciences. She holds a B.A. from Western University, M.Sc. from University of Guelph and Ph.D. from York University. Before joining UBC she taught at DePaul University, York University and the University of Toronto.

Crystal Huscroft

Crystal is an Associate Teaching Professor at Thompson Rivers University. She fell in love with the idea of teaching at the post-secondary level while still in high school and has continued loving it for

over 20 years. Crystal's specialty is surficial geology mapping and stratigraphy. She has co-authored over 25 maps, associated government reports, and peer-reviewed research papers and has applied her knowledge of sediment deposits and landscape processes to reconstructing glacial and volcanic histories, diamond exploration, characterisation of landslide hazards, and the impact of climate change on permafrost processes. Her mapping projects have taken her throughout British Columbia, Alberta, Yukon, and Nunavut Territory. When she is not working, she loves spending time with her family and friends hiking, skiing, and trail running. Despite having to do so during pandemic restrictions, working with the other passionate educators on this project has been one of the recent highlights of her teaching career.

Gillian Krezoski

Gillian (Jill) graduated with a B.A. in geology and history from the University of Wisconsin, Eau Claire and a M.Sc. in Environmental Studies from McMaster University. She began her multidisciplinary career working for a geotechnical firm completing environmental impact assessments at proposed international nuclear sites before transitioning to working as a photographer and eventual lead for the Mars Hand Lens Imager (MAHLI) on NASA's Mars Curiosity Rover. Prior to becoming physical geography senior lab instructor at the University of Victoria, Gillian had taught Earth Sciences part-time for years at several community colleges in California while she worked on rover operations - and absolutely loved it. Sharing a love and excitement for Earth (and Martian!) surface processes with students is a lifelong passion for Gillian.

Allison Lutz

Allison teaches Geography in University Arts and Science, and Hydrology in the School of Environment and Geomatics at Selkirk College, in Castlegar, BC. Allison completed a degree in Geography from the University of Victoria and a master's degree in Geography from York University. Allison has also pursued numerous courses in teaching higher education. Prior to working at Selkirk College, Allison has lived throughout British Columbia, working for the Ministry of Forests and for several environmental consulting firms. In addition to teaching, Allison has a passion for sustainability, and she chaired Selkirk College's Sustainability Committee for many years. She is a board member of Friends of Kootenay Lake and is involved with several local stream monitoring projects. Outside of work, Allison enjoys mountain biking, hiking and skiing in the beautiful West Kootenays with her family and friends.

Stuart MacKinnon

Stuart is an educational program design professional who is currently the Lab Program Manager for the Department of Earth, Environmental and Geographic Sciences at UBC's Okanagan Campus. Within this role, Stuart is responsible for the laboratory curriculum and instruction of first year physical geography and earth and environmental science courses. He holds a B.Sc. in earth and environmental science and a B.Ed. in secondary science education from UBC's Campus, along with a M.Sc. in geography and a graduate certificate in learning and teaching in higher education from the University

of Victoria. Stuart is a certified secondary school teacher who taught middle and high school math and science in both British Columbia and Alberta prior to joining UBC in his current role. During his spare time, Stuart is outside with his family exploring the wonders that BC has to offer and sharing his passion for the planet Earth with his daughter. In developing curriculum, he focuses on experiential learning and the integration of as much field-based learning as is feasible. Stuart coordinated the development of this lab manual and is grateful for the phenomenal group of dedicated educators that came together on short notice to make this all happen.

Craig Nichol

Craig is an Associate Professor of Teaching at the University of British Columbia Okanagan in the Earth, Environmental and Geographic Sciences Department. He holds a Bachelor's degree in geology and M.Sc. and Ph.D. degrees in hydrogeology. He has worked in regional groundwater resources, surface water and groundwater interactions, flow in the unsaturated zone, irrigation and greenhouse gas emissions, and mine waste management. He teaches courses in introductory geoscience, hydrogeology, contaminant transport, geophysics, soil physics and geoscience field techniques. He is an active participant in the water stewardship community of the Okanagan region. His work in geoscience complements a lifelong passion for the outdoors, that sees him out skiing, hiking and climbing when he can.

Andrew Perkins

Andrew is a senior lecturer in the Geography Department of Simon Fraser University. His past research has focused on paleoglacial landscapes and hydrology in south-central British Columbia. At his core, he is a field-based glacial geomorphologist specializing in paleo-landscape reconstruction and rates of geomorphic change. With training in areas of Quaternary geology, sedimentology, geochronology and geophysics and experience in Geographic Information Science, UAV data collection, dendrogeomorphology, and teaching and presenting to diverse audiences, he is most at home working in and enjoying the diverse physical landscape of British Columbia.

Todd Redding

Todd is a Professor in the Department of Geography, Earth and Environmental Science at Okanagan College in Penticton. Todd's formal education includes a B.Sc. in Geography from the University of Victoria, an M.Sc. in Physical Geography from Simon Fraser University and a Ph.D. in Hydrology from the University of Alberta. Prior to joining Okanagan College, he worked in forest watershed research for the BC Ministry of Forests and in watershed extension with FORREX. Todd has conducted research and taught about a wide range of topics including soils, snow, streams, surficial geology, terrain stability, weather and climate and terrestrial ecosystems. In his off time, Todd spends time with his family skiing, mountain biking and hiking across our beautiful BC landscapes.

Ian Saunders

Ian holds a B.Sc. (Hons) in Environmental Sciences from the University of East Anglia, and a M.Sc. and Ph.D. in Geography from Simon Fraser University (SFU). His research has included work in geomorphology, Quaternary geology, and a variety of sub-disciplines in climatology. Most of his research has been undertaken in mountainous settings in western Canada. In the past 30+ years Ian has taught physical geography courses at SFU, University of Lethbridge, Okanagan University College, and UBC Okanagan. His teaching experience spans a broad range of physical geography themes but mostly in climatology, meteorology, cartography, remote sensing, and the physical environments of British Columbia.

Leonard Tang

Leonard is a physical geographer with particular interests in meteorology and climatology. His love of travelling led him to Boston for his undergraduate and Los Angeles for his graduate work. Since moving back to Vancouver, he has been teaching at Langara College for the past 20 years. Outside of work, he enjoys going on “field trips” with his son, spending time with his family and friends, and looking up into the sky.

Chani Welch

Chani teaches physical geography and environmental science for the Department of Geography, Earth and Environmental Science at Okanagan College between geoscience and hydrology research projects. She holds a Bachelor’s degree in Environmental Engineering from the University of New South Wales (Australia) and a Ph.D. in Hydrology from Flinders University (Australia). She moved to Canada to learn about snow-driven hydrological systems after a decade of diverse work in the hotter climates of Australia, Asia, and the Middle East. Chani has a particular interest in measurement-driven science, specifically focused on explaining water flow through inter-linked surface and groundwater flow paths. She likes to share this hands-on approach with her students. Chani’s favourite place to be is outside, preferably in wild places surrounded by water.

Versioning History

This page lists major changes to this book with major changes marked with a 1.0 increase in the version number and minor changes marked with a 0.1 increase.

Version	Date	Change
1.0	August 31, 2020	The first version of the lab manual is created.
2.0	August 1, 2021	The second version of the lab manual is created.